

# Orkot<sup>®</sup> Bearings for Floating Wind Power



# Floating Offshore Wind Power

## RENEWABLE ENERGY FOR A SUSTAINABLE FUTURE

Wind power is the most developed alternative energy source globally. Growth has been driven by rising fuel prices, an increasing concern for the environment and a need for countries to enhance their energy security.

Some 43 years after the world's first wind turbine came online, the historic milestone of 1 TW of worldwide installed wind power capacity was reached in 2023, taking nearly 40 years to achieve. Global policies are driving this towards 2 TW by the end of 2030, a further doubling of capacity in just seven years.

Offshore wind makes up a major part of this capacity, with ever-greater ambitions for larger turbines further out to sea where they require floating platforms. Selecting the optimal materials to construct these long-lasting, environmentally sensitive and efficient offshore wind platforms is critical.

### Key considerations for floating offshore wind power materials:

- **Dimensional stability** – will materials change with time and in response to environmental conditions; e.g. do they swell in seawater?
- **Environmental impact** – will the materials avoid any negative impact on ecosystems and the environment; e.g. do bearings require lubrication and grease that can leak or leach?
- **Effect on adjacent parts in the system** – will materials contribute to corrosion or wear; is cathodic protection provided?
- **Service life** – will the materials last for the system lifetime; are they low wearing and long lasting?
- **Durability** – will the materials perform in harsh environments and provide resistance to prevailing temperatures, sea water, grit and contamination?

Trelleborg has supplied components for wind turbines since the technology was first developed. Numerous Orkot® advanced composite bearings and wear rings from Trelleborg Sealing Solutions contribute to effective operations of critical hydraulics components, withstanding the challenges faced on land and demanding conditions offshore.

Orkot® has a proven heritage in mooring systems and a long history of providing wear ring solutions for multiple applications including:

- Mooring
- Fairleads
- Spreader bars
- Padeyes
- In-line tensioners
- Shackles
- Mid-water arches
- Slewing/yaw ring pads
- Turbine blade pitch actuators

### SERVICE & SUPPORT

Trelleborg Sealing Solutions has experienced and highly skilled engineers that offer a complete service, tailored to your requirements. Orkot® bearings are available in sizes from 8mm to 2m in diameter, with laminates available up to 3m x 1.3m x 40mm.

**For support, general enquiries and orders, contact your local Customer Solution Center.**

### FURTHER INFORMATION

Orkot® C620



Marine Bearings



Industrial Bearings



# Orkot® Bearing of Choice

## PROVEN PERFORMANCE

Orkot® has a 60-year heritage as a bearing, wearing and thrust pad material in subsea, mooring, oil and gas, hydro, marine and energy production applications.

It is a composite material comprised of a woven fabric reinforcement and solid lubricants encased in a thermoset resin matrix. This composition gives Orkot® its excellent wear characteristics and long working life, low-friction properties that enhance application efficiency, and high resistance to swell, ensuring it remains dimensionally stable in fluid-exposed environments.

Trelleborg Sealing Solutions' global manufacturing footprint supplies bearings from multiple sites worldwide, all maintaining the same exacting standards and certified to:

- ISO 9001
- ISO 14001
- ISO 45001

These attributes ensure that delivery is always achieved.



### Orkot® exhibits an extraordinary range of benefits ideal for the floating offshore wind segment:



**Friction** – Orkot® products have very low friction coefficients - as low as 0.05 - and excellent stick-slip properties, ensuring smooth running



**Cathodic protection** – as an insulating material, Orkot® provides a barrier between dissimilar metals and offers protection from cathodic corrosion



**Durability** – Orkot® exhibits very low wear rates and long product lifetimes as it does not break down within the application's design life, and possesses high impact strength  $\geq 120$  kJ/m<sup>2</sup>



**Excellent chemical resistance** – Orkot® offers great resistance to chemical attack; advanced Orkot® grades offer extended protection against chemicals and elevated temperatures



**Dimensionally stability** – Orkot® has low swell rates of < 0.1 %, meaning it performs as required in marine environments



**Does not promote marine growth** – Orkot® does not increase marine growth, extending the product and application lifetime



**Capability to replace metal bearings** – Orkot® is an ideal replacement for metal bearings, able to match or exceed load capabilities while offering additional benefits such as low maintenance and longer product lifetime



# Orkot® Maintenance Free

## DURABLE AND LONG LASTING IN DEMANDING ENVIRONMENTS

Orkot® offers a range of material grades with differing specific properties, but all related by their common features including low wear rates, excellent frictional properties and dimensional stability.

TLM Marine (TLMM) and TXM Marine (TXMM) are the standard marine and premium marine Orkot® grades, used extensively in at-sea applications, from sub-sea mooring connectors to top-side slewing bearings.

TLMM and TXMM are “fit and forget” materials. They need no maintenance as lubrication is not required, wear rates are minimal and they do not degrade with time, whether submerged or not. They show excellent resistance to wear in test conditions representative of the seabed with gritted sea water.

### Orkot® Marine Grades - Pressure Friction

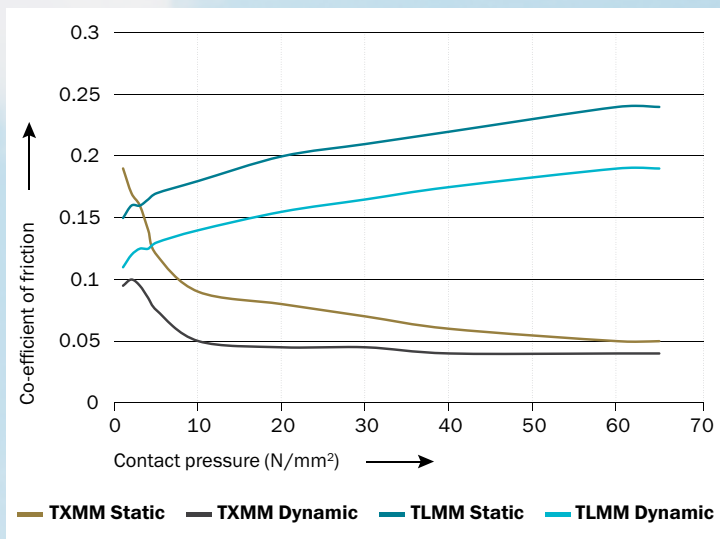

TLMM is ideal in applications below or at the waterline as the water provides additional lubrication.

TXMM incorporates Orkot®’s proprietary low-friction running surface, offering a friction co-efficient as low as 0.05. As the load increases on the bearing, the frictional performance of the material continues to improve due to increased activation of the PTFE. The PTFE layer is several millimetres thick, making it highly tolerant to wear, while maintaining its low-friction properties throughout the long service life of the bearing.

TXMM has proven to be particularly effective at reducing stick-slip problems, thus ensuring that systems run smoothly and without judder or rapid breakout.

Mechanical Properties	TLMM	TXMM
<b>Compressive strength – N/mm<sup>2</sup></b>		
Normal to laminate	300	280
Parallel to laminate	90	90
<b>Tensile strength – N/mm<sup>2</sup></b>	60	55
<b>Flexural strength – N/mm<sup>2</sup></b>	65	65
<b>Shear strength – N/mm<sup>2</sup></b>	80	80
<b>Impact strength Charpy impact</b>		
Unnotched – kJ/m <sup>2</sup>	120	120
Normal to laminate		
<b>Hardness – Rockwell M</b>	90	90
<b>Density – g/cm<sup>3</sup></b>	1.3	1.3
<b>Swell in water, % of wall thickness</b>	< 0.1	< 0.1
<b>Thermal expansion coefficient</b>		
<b>20–100 °C (per °C x 10<sup>-5</sup>)</b>		
Normal to laminate	9 – 10	9 – 10
Parallel to laminate	5 – 6	5 – 6
<b>Sliding properties*</b>	0.13	0.05

\*Typical coefficient of friction running dry against a corrosion-resistant surface such as stainless steel. Bearing pressure 15 N/mm<sup>2</sup>

# Test Capabilities

## ENSURING CAPABILITIES EXCEED REQUIREMENTS

To compliment the supply of high-performance, long-lasting bearings, Trelleborg Sealing Solutions has a suite of advanced test rigs and equipment, and works with partners to offer extended testing capabilities

Bespoke testing to validate bearing designs, materials and operating conditions is also available, providing confidence that Orkot® solutions meet the demanding needs of offshore floating wind power.

Capabilities include dry and fluid-immersed wear, lifetime and friction testing, compression and tensile testing and fluid compatibility.

FEA analysis to further predict bearing performance and enhance confidence in the solution can also be provided.

Orkot® offers exceptionally low wear rates against a range of counter-face materials and roughness. Testing TXMM against a typical 316L stainless steel counterface while immersed in water reveals wear typically around  $10^{-16} \text{ m}^3/\text{Nm}$ .

For small reciprocating movements, typical in many mooring applications, there is minimal variation in wear rates for counterfaces with roughness from 0.3 up to 3.0  $\mu\text{m}$   $R_a$ .

TXMM remains effective even in particularly gritted water at the sea bed containing sand and marine particles.

Impressive wear rates of  $10 \times 10^{-16} \text{ m}^3/\text{Nm}$  are demonstrated by TXMM immersed in water with a 1% wt/wt 100  $\mu\text{m}$  particle size silica sand contamination.

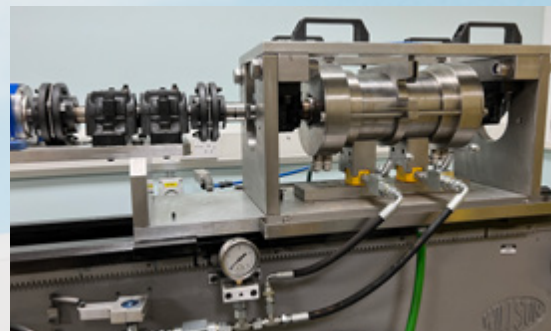

Pressure MPa	Speed mm/s	Wear Rate $\text{m}^3/\text{Nm}$
10	1	$1.11 \times 10^{-15}$
5	5	$1.19 \times 10^{-15}$

TXM Marine  
100  $\mu\text{m}$  particle size silica sand at 1% wt/wt

Typical wear rates of TXM Marine in gritted water

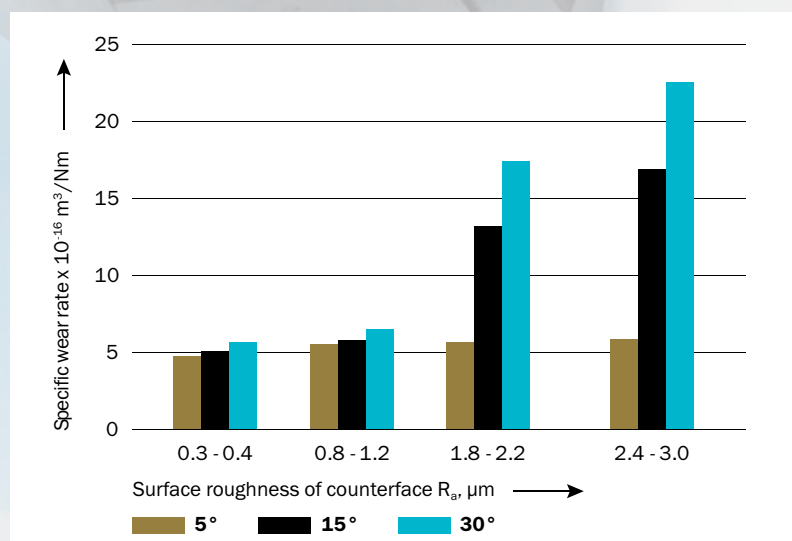

Specific wear rate of TXM Marine, water immersed against 316L stainless steel of different surface roughness, 0.5 m/min at 5°, 15°, 30° angle of reciprocation, 20 N/mm<sup>2</sup>

# Bearings and Wear Rings in the Nacelle

## LOW FRICTION FOR OPTIMAL PERFORMANCE

Whether on land or at sea, Trelleborg Sealing Solutions offers a range of Orkot® advanced composite bearings and wear rings to assist the effective operation of equipment in all conditions. In and around the nacelle, Orkot® bearings and wear rings ensure smooth running of slewing systems, blade pitch control and braking systems.

### BRAKING SYSTEM

Orkot® bearings can be used in the main brake which assists the turbine in stopping at critical motor speeds or during maintenance. Additionally they can be employed in the yaw brake which keeps the nacelle steady and in an optimum position relative to the wind direction.

#### Optimum materials: C380, C480

- Peak efficiency and reliability with market-leading wear band Slydring® designs
- Fluid compatibility with industrial lubricants

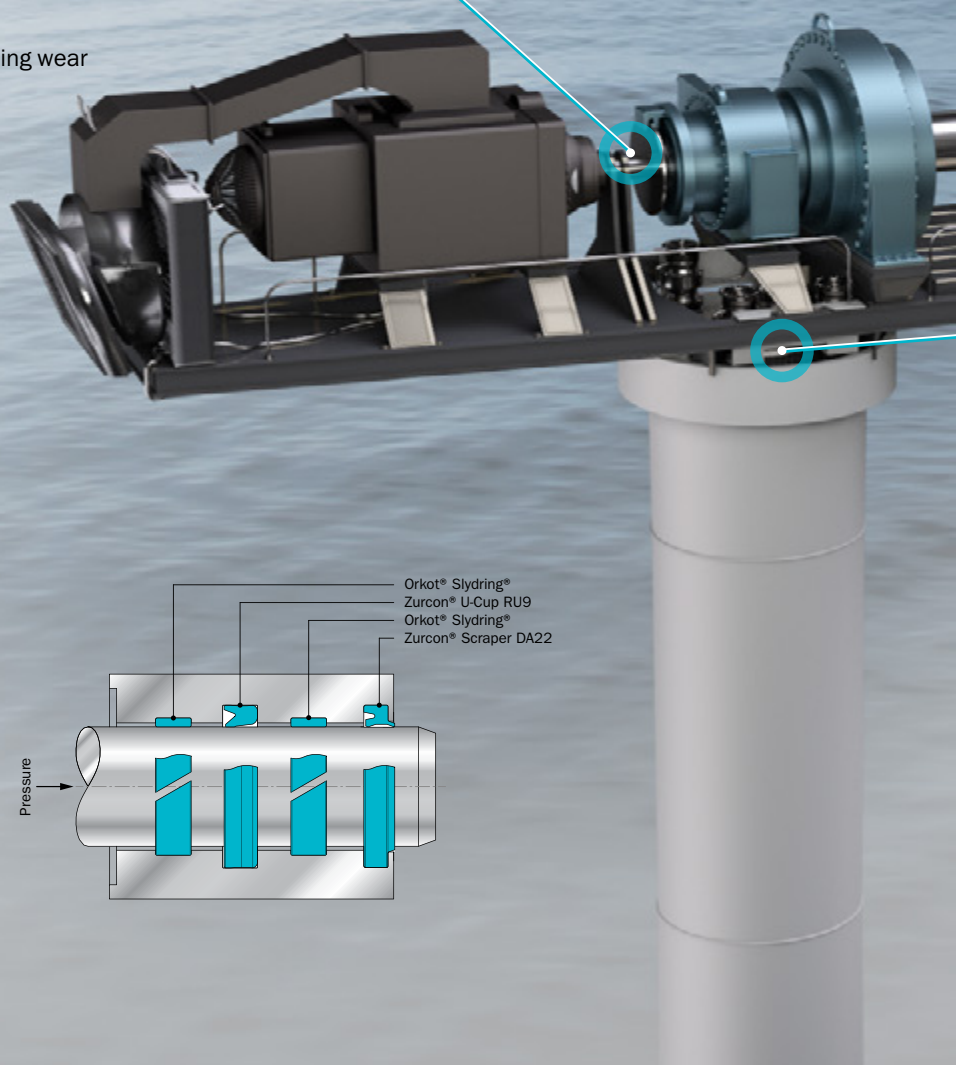
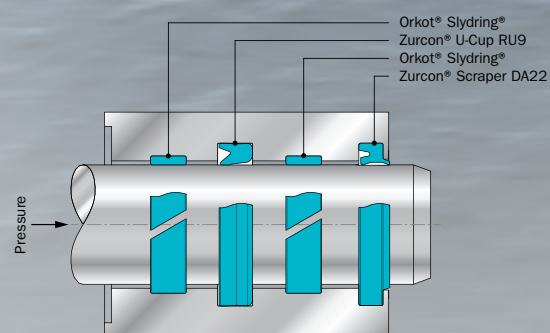
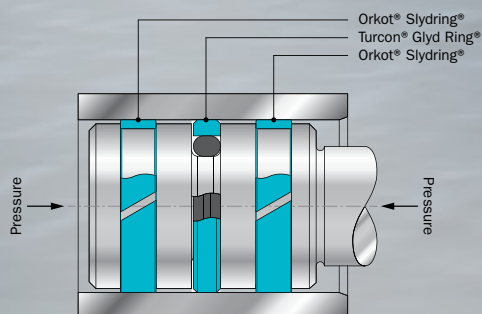
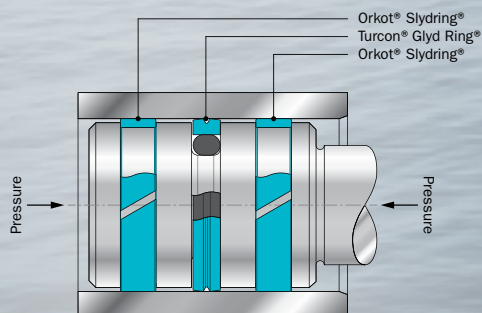



WIND TURBINE PITCH CYLINDERS

Trelleborg offers a wide range of components and assemblies for hydraulic and actuation systems. Orkot®'s very low coefficient of friction allows smooth operation at high loads and low speeds.

Optimum materials: C380, C480

- Peak efficiency and reliability with market-leading Slydring® designs
- Fluid compatibility with industrial lubricants

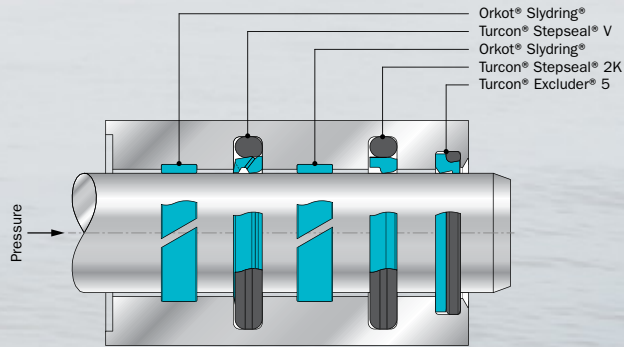
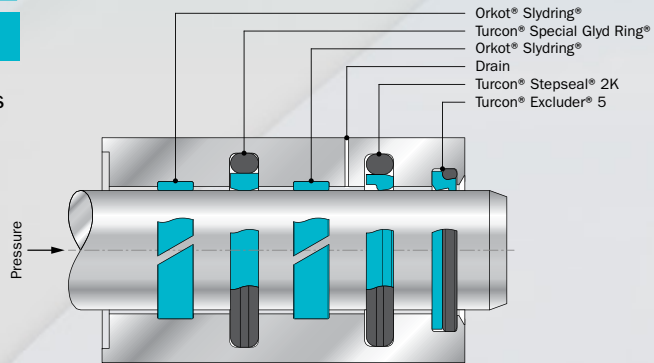
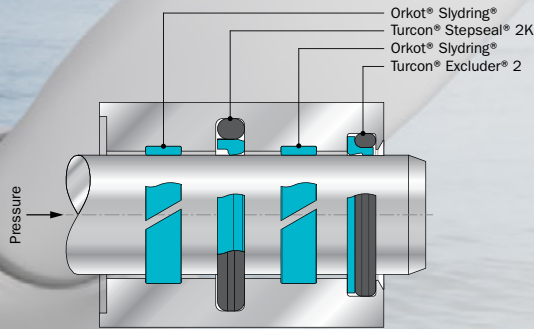

SLEWING YAW PADS

Slewing yaw pads are bearings that allow the turbine to orient to optimal position for wind direction. The slewing pads reduce the friction between the turbine and the tower allowing smooth transition.

Optimum materials: TLMM, TXMM

- Low friction and wear
- Excellent in harsh environments



# Mooring Systems

## PROVEN PERFORMANCE IN TOUGH CONDITIONS

As offshore wind turbines increase in size and are positioned further out to sea, the optimal designs are floating platforms. All of the leading floating foundation concepts require mooring to the seabed.

Mooring systems comprise mooring lines, anchors and connectors. They keep ships and floating platforms stationary on the surface in all water depths. Floating turbines are primarily considered for projects in water deeper than 50-60 meters. Regardless of the platform's mooring system, Orkot® has an effective solution.

### FAIRLEADS AND TENSIONER RISERS

The low wear rates of Orkot® allow for continuous operation without compromising on performance. It can be used as radial bushes and thrust washers in fairleads or wear rings within tensioner risers.

#### Optimum materials: C620, TXMM, C324

- Orkot® C324 has fluid compatibility with HFA & HFC hydraulic fluids whilst running at temperatures greater than +100 °C
- Low wear and maintenance requirements in continuous applications

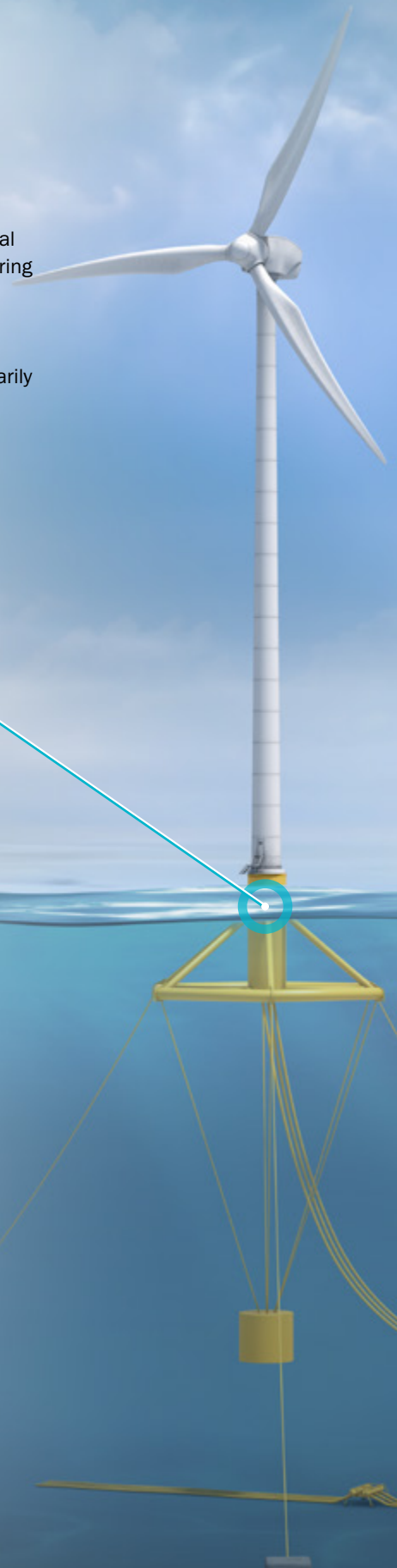
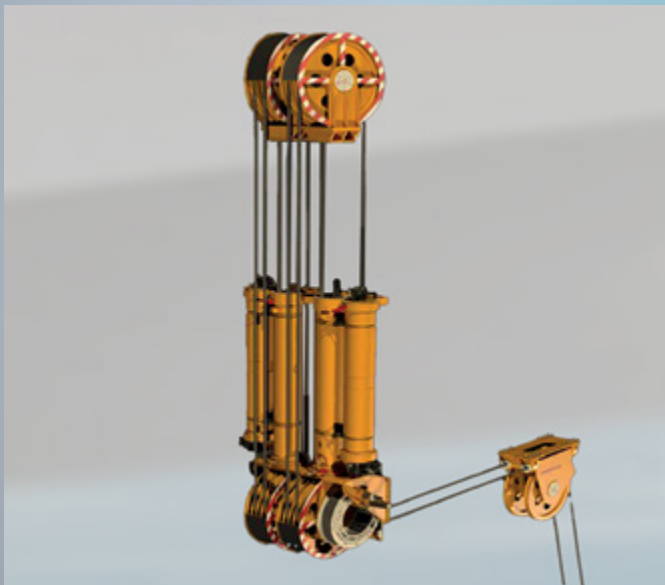



### FLOATING PLATFORM DESIGNS FOR OFFSHORE WIND TURBINES

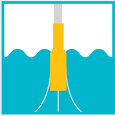

**Spar**  
Stability due to ballasting

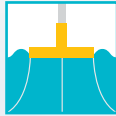

**Barge**  
Stability through bouyancy



**Tension Leg Platform**  
Stability through mooring tension

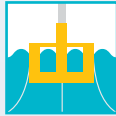

**Semi-submersible**  
Stability through buoyancy

#### MID-WATER ARCHES (MWA)

Orkot® is used throughout the MWA's supporting risers, cables and umbilicals from the seabed to the vessel/platform. It is manufactured into separate bearings and washers to ensure the direction of lamination is strongest to withstand high loads.

**Optimum materials: C620, TXMM, TLMM**

- High compressive strength in both axial and radial directions
- Minimal swell and no galvanic corrosion

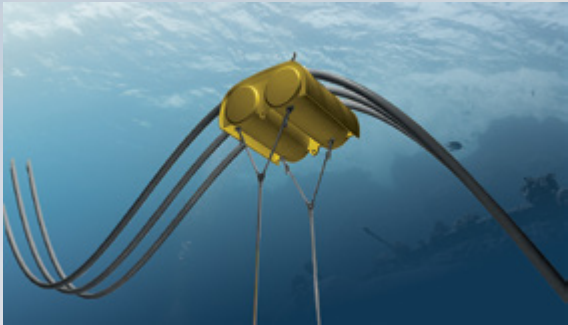

#### SPREADER BAR PADEYES

Trelleborg offers a wide range of components and assemblies for hydraulic and actuation systems. Orkot® has a very low coefficient of friction, allowing smooth operation at high loads and low speeds.

**Optimum materials: TLMM, TXMM, C620**

- Peak efficiency and reliability with market-leading Slydring® designs
- Fluid compatibility with industrial lubricants

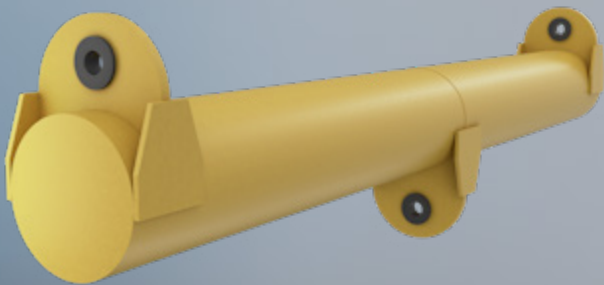

# Case Study FPSO Mooring Line

## PERFORMANCE THAT LASTS

Orkot® bearings were fitted in 1998 into mooring line links for an FPSO moored in West Africa.

In 2023, after 25 years of permanent use underwater, the top parts of the spiral strand wires were recovered and inspected.

After examination, the operator TotalEnergies decided that the original bearings were still in excellent condition and fit for purpose for the FPSO life extension.

Orkot® TLMM bearings were originally chosen as the impregnated fillers in the material to provide a low-friction bearing surface and exhibit little wear when submerged in water. TLMM has a high load capability and does not promote corrosion on the counter faces, helping it to protect not only the hardware but the bearing itself.

### Other Applications for Orkot® TLMM

- High static load cranes
- Calm buoys
- Renewable anchoring
- Pulley/winch bushes
- Christmas trees (oil & gas)

### Service Experience

- Promotes limited or no marine growth
- Low wear – bush can remain in service for longer
- Very little to no swell in water – dimensional stability allows free movement of shaft during long life
- No creep in service

### Benefits/Features

- Maintenance free for lifetime of bearing
- Dimensional stability underwater
- Low friction when submerged in water

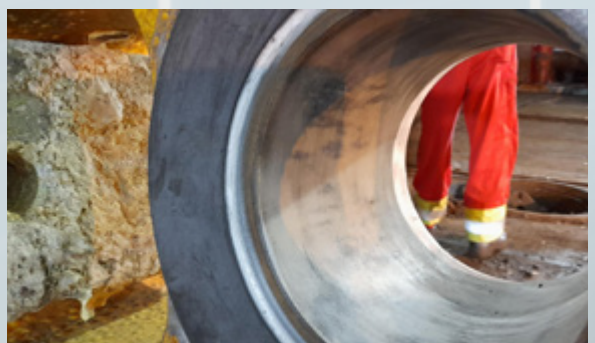
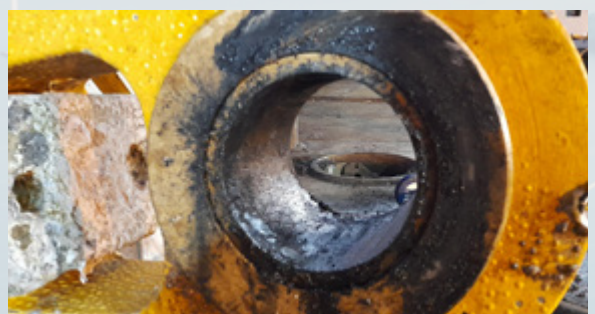



# Orkot® C620

## HIGH LOAD BEARING WHEN PERFORMANCE IS CRITICAL

The load on mooring systems and associated bearings has increased as turbines have grown in size. Orkot® C620 is engineered and rigorously tested to ensure increasing demands are met with confidence.

Its glass-fibre backing provides the strength, while Orkot®'s proprietary TX lining minimizes friction and ensures high stick-slip performance. Mooring systems can move smoothly avoiding the high-force whipping that occurs with bearings with poor stick-slip properties.

Orkot® C620 has an outstanding ultimate compressive strength of 470 N/mm<sup>2</sup>. The design limit of 400 N/mm<sup>2</sup> allows engineers to meet the ever-increasing needs of larger wind turbines and platforms. Whether in the nacelle or in the mooring system, Orkot® C620 provides a strong bearing material with excellent impact strength to protect against shocks, very low swell (< 0.1%) and excellent dimensional stability.

Orkot® C620 also utilises Trelleborg's proprietary TX running face material for an ultra-low friction coefficient, ensuring that equipment runs smoothly and efficiently, minimising the risk of whipping in mooring lines and juddering in slewing mechanisms due to its excellent stick-slip properties.

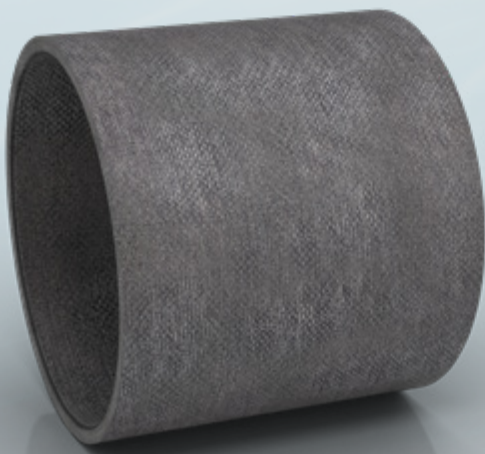
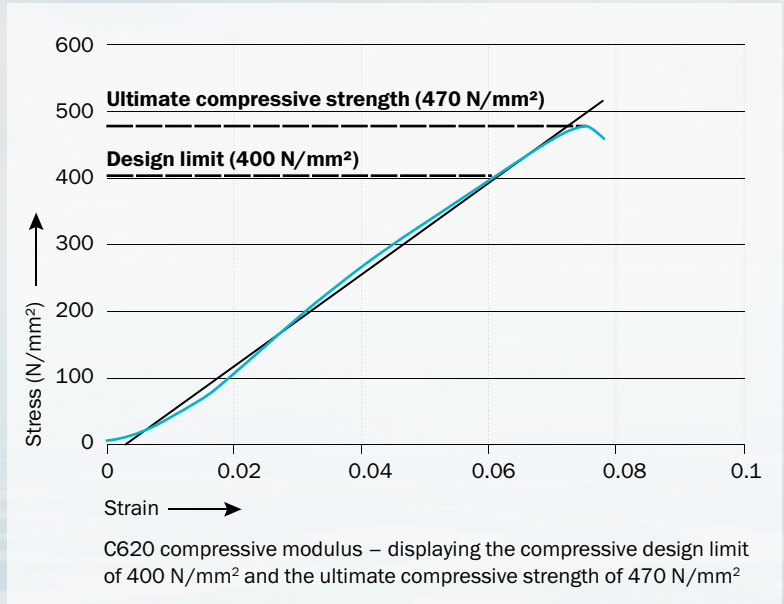

Mechanical Properties	C620
<b>Compressive strength – N/mm<sup>2</sup></b>	
Normal to laminate	470
Parallel to laminate	220
<b>Tensile strength – N/mm<sup>2</sup></b>	
<b>Flexural strength – N/mm<sup>2</sup></b>	
<b>Shear strength – N/mm<sup>2</sup></b>	
<b>Impact strength Charpy impact</b>	
Unnotched – kJ/m <sup>2</sup>	200
Normal to laminate	
<b>Hardness – Rockwell M</b>	100
<b>Density – g/cm<sup>3</sup></b>	1.9
<b>Swell in water, % of wall thickness</b>	< 0.1
<b>Thermal expansion coefficient</b>	
<b>20–100 °C (per °C x 10<sup>-5</sup>)</b>	
Normal to laminate	0.5 – 1.0
Parallel to laminate	2 – 3
<b>Sliding properties*</b>	0.05

\*Typical coefficient of friction running dry against a “corrosion-resistant” surface such as stainless steel. Bearing pressure 15 N/mm<sup>2</sup>



Trelleborg is a world leader in engineered polymer solutions that seal, damp and protect critical applications in demanding environments. Its innovative solutions accelerate performance for customers in a sustainable way.

Trelleborg Sealing Solutions is a leading developer, manufacturer and supplier of precision seals, bearings and custom-molded polymer components. It focuses on meeting the most demanding needs of aerospace, automotive and general industrial customers with innovative solutions.

[WWW.TRELLEBORG.COM/SEALS](http://WWW.TRELLEBORG.COM/SEALS)



[facebook.com/TrelleborgSealingSolutions](https://facebook.com/TrelleborgSealingSolutions)  
[x.com/TrelleborgSeals](https://x.com/TrelleborgSeals)  
[youtube.com/TrelleborgSeals](https://youtube.com/TrelleborgSeals)  
[linkedin.com/company/trelleborg-sealing-solutions](https://linkedin.com/company/trelleborg-sealing-solutions)  
[instagram.com/trelleborgsealingsolutions](https://instagram.com/trelleborgsealingsolutions)

If you'd like to talk to Trelleborg Sealing Solutions, find your local contact at: [www.trelleborg.com/seals/worldwide](http://www.trelleborg.com/seals/worldwide)