

Trelleborg 601 Power-Lock

Integrated sealing system for plastic pressure pipes

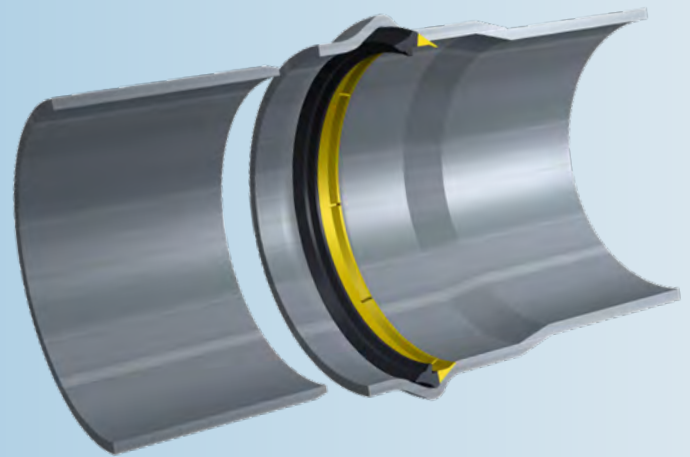

KEY FEATURES AND BENEFITS

- Greater joint reliability due to joint tolerance reduction
- Fully automated insertion eliminates risk of human error
- Low jointing force, eliminating risk of seal displacement

SEAL DESIGN AND FUNCTION

Trelleborg 601 Power-Lock is integrated into the pipe during the manufacturing process. By heating the pipe and using the mandrel together with the seal as a tool to form the socket, the seal is effectively shaping its own groove. This reduces irregularities and tolerances in the socket.

The seal is equally effective under positive and negative pipe pressure (vacuum). Under positive pressure, the higher the pressure the greater the sealing force. Under vacuum, the seal maintains a positive sealing force against spigot and socket, preventing sand or soil to enter the joint.

The Trelleborg 601 Power-Lock is a composite seal consisting of:

1. A flexible rubber element to seal effectively against spigot and socket
2. A polypropylene reinforcement element, which holds the seal firmly in place

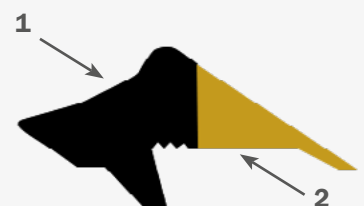

JOINT ASSEMBLY

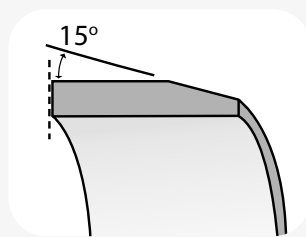

Inspect the spigot, socket and seal for damage and remove any dirt or dust prior to assembly. Chamfer the spigot end and remove all burrs.

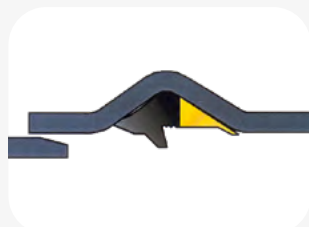

Apply lubricant to the spigot end and immediately bring it into contact with the socket.

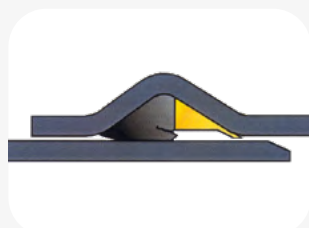

Align spigot and socket, and slide the spigot into the pipe, past the seal.

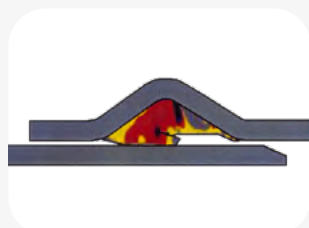

As the pipes are joined the rubber sealing element is deformed and creates pressure against both spigot and socket resulting in a watertight seal.

APPROVALS

- CE-marking
- BSI "Kitemark"
- Swedcert
- IRAM
- Watermark
- ACS
- WRAS

STANDARDS

- EN 681-1 WC, WA
- AS1646, AS/NZS 4020
- IRAM 113035
- AFNOR XP P 41-250
- BS 6920
- NOM-001-CONAGUA
- NMX T-021

SIZE CHART

PIPE SIZE (mm)	A (mm)	B (mm)
50	8.0	17.2
63	8.0	17.3
75	9.0	20.0
90	11.0	24.3
100-S2*	14.0	32.3
110	12.0	26.6
125	14.0	32.3
140	14.0	32.0
150-S2*	16.0	35.9
160	15.0	33.5
200	16.0	35.9
200-S2*	17.0	37.1
225	17.0	37.1
250	19.0	42.9
250-S2*	20.0	43.6
280	20.0	43.6
315	21.0	45.8
355	23.0	50.2
400	25.0	54.5
450	23.5	58.2
500	30.0	65.4
630	37.0	83.9
710	41.0	92.3

*Seal for Australian Standard AS-4441

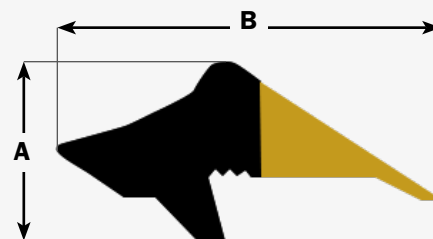

MATERIAL

- Synthetic rubber (EPDM)
- Hardness 50±5 IRHD
- Approved for drinking water

Trelleborg proven quality:



TRELLEBORG

WWW.TRELLEBORG.COM/EN/SEALS-AND-PROFILES/