

# User manual: pneumatic plugs

# 1.0. TABLE OF CONTENTS

<b>1.0. TABLE OF CONTENTS</b>	<b>2</b>
<b>2.0. LIST OF ATTACHMENTS</b>	<b>3</b>
<b>3.0. GENERAL INFORMATION ABOUT THE PRODUCT FAMILY</b>	<b>3</b>
3.1. PURPOSE AND FIELD OF APPLICATION	3
3.2. IMPORTANCE OF INSTRUCTIONS	3
3.3. CONFORMITY TO STANDARDS	4
3.4. MANUFACTURER	4
<b>4.0. DEFINITIONS</b>	<b>5</b>
<b>5.0. USER SAFETY INFORMATION</b>	<b>6</b>
5.1. SAFETY INSTRUCTIONS BEFORE USE	6
5.2. PERSONAL PROTECTIVE EQUIPMENT	6
5.3. ENVIRONMENTAL CONDITIONS AND RESTRICTIONS	7
5.4. CARRYING OF PRODUCTS	8
5.6. STORAGE AND PROTECTION OF PRODUCTS NOT IN SERVICE	8
5.7. USE OF SAFETY SUPPORT	9
5.8. CHOOSING THE RIGHT PNEUMATIC PLUG	9
<b>6.0. PRODUCT IDENTIFICATION</b>	<b>12</b>
6.1. PRODUCT DESIGNATION	12
6.2. LIFETIME	14
<b>7.0. COMPONENTS OF THE PNEUMATIC PLUG SYSTEM</b>	<b>14</b>
7.1. PNEUMATIC PLUG SYSTEM	14
7.2. AIR SOURCE	14
7.3. CONTROLLER	15
7.4. INFLATION HOSES	17
<b>8.0. USE OF PNEUMATIC PLUGS</b>	<b>17</b>
8.1. INSERTING THE PNEUMATIC PLUG INTO THE PIPELINE	17
8.2. REMOVING THE PNEUMATIC PLUG FROM THE PIPELINE	20
<b>9.0. POSSIBLE USES OF PNEUMATIC PLUGS</b>	<b>22</b>
9.1. TEMPORARY SEALING OF PIPELINES WITH PNEUMATIC PLUGS	22
9.2. PREPARATION OF A BYPASS WITH PNEUMATIC PLUGS	24
9.3. TESTING WITH PNEUMATIC PLUGS	24
<b>10.0. FAULT IDENTIFICATION AND UNEXPECTED SITUATIONS</b>	<b>27</b>
<b>11.0. ACCESSORIES</b>	<b>28</b>
<b>12.0. CLEANING OF PNEUMATIC PLUG SYSTEM</b>	<b>28</b>
12.1. CLEANING OF PNEUMATIC PLUGS	29
12.2. CLEANING OF INFLATION HOSES	30
12.3. CLEANING OF CONTROLLERS	30
12.4. REPLACING THE COUPLING AND EYEBOLTS ON THE PNEUMATIC PLUG	30
<b>13.0. MAINTENANCE OF PNEUMATIC PLUG SYSTEM</b>	<b>32</b>
13.1. TEST PROCEDURES	33
13.2. CRITERIA INTERPRETATION	35

## 2.0. LIST OF ATTACHMENTS

ATTACHMENT 1:	Warranty statement
ATTACHMENT 2:	Quick start guide
ATTACHMENT 3:	Media resistance table
ATTACHMENT 4:	Technical characteristics of products
ATTACHMENT 5:	Pillow plugs, conical plugs, house connections test kit, air leak test, water leak test
ATTACHMENT 6:	Table of controllers, Table of inflation hoses

## 3.0. GENERAL INFORMATION ABOUT THE PRODUCT FAMILY

### 3.1. PURPOSE AND FIELD OF APPLICATION

Pneumatic plugs are designed for temporary sealing of pipelines in municipal, industrial and water supply, as well as for maintenance and testing of pipelines.

### 3.2. IMPORTANCE OF INSTRUCTIONS



Please read the user manual carefully before using the product and keep it for future reference. The user manual must be available to all users of the pneumatic plugs.

The long version of the user manual is available on the websites at:

<https://www.trelleborgslovenija.com/en/products-and-solutions/environmental-protection-and-rescue-products/downloads/manuals>

Each pneumatic plug has the manufacturer's test report attached. Quick tips for working with pneumatic plugs are also included.







A quick start guide for working with pneumatic plugs is included with each product and can also be found on the back page of the user manual. We suggest that you laminate that page and enclose it to the pneumatic plugs to make it available to users at all times.

#### 3.2.1. INTERPRETATION OF PICTOGRAMS

The pictograms used in the user manual are explained in the table below. Other markings in the user manual are clear and unambiguous.

Table 1:

PICTOGRAM	MEANING	EXPLANATION
	<b>HAZARD</b>	A signal word indicating a potential high-risk hazard which, if not avoided, could result in death or serious injury.
	<b>WARNING</b>	A signal word indicating a potential medium-risk hazard which, if not avoided, could result in death or serious injury.
	<b>CAUTION</b>	A signal word indicating a potential low-risk hazard which, if not avoided, could cause minor or moderate injury.
	<b>INFORMATION</b>	A signal word indicating a risk of material damage and/or damage to property. There is no risk for injuries.

### 3.2.2. RELEVANCE OF FIGURES IN THE USER MANUAL

All images, drawings and photographs in the user manual are for illustration purposes only.

### 3.3. CONFORMITY TO STANDARDS

Pneumatic plugs are not subject to the manufacture according to standards.

### 3.4. MANUFACTURER



# TRELLEBORG

**TRELLEBORG SLOVENIJA, d.o.o.**

PG Environmental Protection & Rescue Products

Škofjeloška cesta 6  
4000 Kranj, Slovenia

T: + 386 4 206 63 88  
F: + 386 4 206 63 90

E: [tis.kra.info.eko@trelleborg.com](mailto:tis.kra.info.eko@trelleborg.com)

W: [www.trelleborgslovenija.com](http://www.trelleborgslovenija.com)

## 4.0. DEFINITIONS

The meaning of words and phrases in the user manual is explained in the table below.

Table 2:

WORD / PHRASE	MEANING
<b>Pneumatic plug</b>	A device for temporary sealing of pipelines where it is necessary to temporarily hold back the medium in the pipeline or carry out a pressure test. When used, the plug should be filled with compressed air.
<b>Blocking pneumatic plug (Plugy)</b>	A pneumatic plug that completely stops the flow through the pipeline.
<b>Bypass pneumatic plug (Plugsy)</b>	A pneumatic plug that partially stops the flow in the pipeline and allows the medium to flow through a bypass in a controlled way.
<b>Working pressure</b>	The prescribed pressure in the pneumatic plug during use.
<b>Prescribed inflation pressure</b>	The pressure in the pneumatic plug prescribed by the manufacturer.
<b>Back pressure</b>	The pressure of the media acting on the pneumatic plug inserted in the pipeline.
<b>Controller</b>	A device for the supply, discharge and control of the filling medium in the pneumatic plug.
<b>Safety valve</b>	A pneumatic element that protects the pneumatic plug against excessive working pressure.
<b>Inflation hose</b>	All hoses required for inflation of pneumatic plugs.
<b>Air hose</b>	A hose between the air source and the controller.
<b>Connecting hose</b>	A hose between the controller and the pneumatic plug.
<b>Inlet coupling</b>	A coupling on the controller for connection of the air hose.
<b>Outlet connector</b>	A connector on the controller for connection of the connecting hose.
<b>Medium</b>	Gas or liquid in contact with the outer surface of the pneumatic plug during use.
<b>Pipe diameter</b>	Inner (clear) diameter of the pipe in which the pneumatic plug is inserted.
<b>Usage range</b>	The working area of the plug defined by the maximum and minimum diameter of the pipe in which the pneumatic plug is inserted.
<b>Contact surface</b>	The surface of the plug that contacts the wall of the pipe in which the pneumatic plug is inserted.
<b>Safety support</b>	A properly designed support to prevent undesired movement or ejection of the pneumatic plug from the pipe.
<b>Danger zone</b>	An area where the safety of people is at risk due to an uncontrolled release of the media, potential product failure or unexpected movement of both pneumatic plug and safety support.
<b>Pneumatic plug cover</b>	A flat part of the cylindrical pneumatic plug equipped with the inflation connector.
<b>Pneumatic plug bottom</b>	A flat part of the cylindrical pneumatic plug on the opposite side of the cover.
<b>Pneumatic plug body</b>	A cylindrically shaped body of the plug that symmetrically connects its cover and bottom.
<b>Reinforced pneumatic plugs</b>	Pneumatic plugs with an integrated textile-cord structure.
<b>Non-reinforced pneumatic plugs</b>	Pneumatic plugs without an integrated textile-cord structure.
<b>NR/BR plugs</b>	Plugs made from NR/BR rubber.
<b>CR plugs</b>	Plugs made from CR rubber.
<b>NBR plugs</b>	Plugs made from NBR rubber.

## 5.0. USER SAFETY INFORMATION

### 5.1. SAFETY INSTRUCTIONS BEFORE USE

Working with pneumatic plugs must be carried out under the guidance of professionally qualified persons who ensure compliance with the regulations. The procedures must be supervised by qualified persons (supervisors) having appropriate experience.

The instructions for the manufacture, production and supervision of the products made by Trelleborg Slovenija, PG EKO, always take into account a high level of safety that is binding not only on the manufacturer but also the user. The user and the manufacturer must always follow the instructions for safe and proper use of pneumatic plugs.

Should you have any questions or in case of circumstances not described in the user manual, consult the supervisor or the safety engineer in charge.

We recommend that all users of pneumatic plugs receive training from the manufacturer or an authorized training provider.



When working with pneumatic plugs, we recommend that you use original accessories, which can be obtained from the manufacturer.

### 5.2. PERSONAL PROTECTIVE EQUIPMENT

Always wear personal protective equipment when working with pneumatic plugs: safety helmet, safety goggles, safety gloves, safety footwear, hearing protection.



Despite the use of protective equipment, it is forbidden to stay in the danger zone of the plug during operation. In addition to the pipeline, all manholes in the vicinity of the plug installation site, including shafts, are also considered a danger zone. In the event of a product failure, the resulting shock wave propagates in the form of a cone.

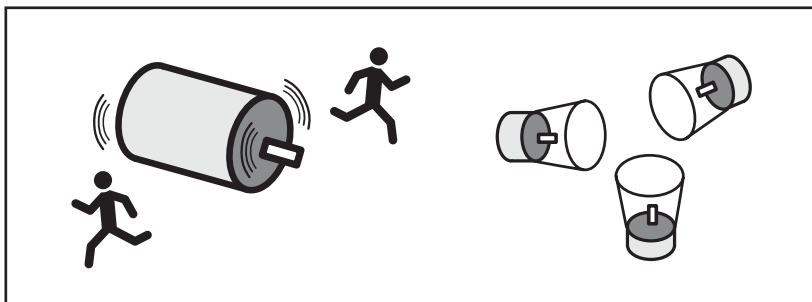

Figure 1: Staying in the danger zone is forbidden

### 5.3. ENVIRONMENTAL CONDITIONS AND RESTRICTIONS

Always wear personal protective equipment when working with pneumatic plugs: safety helmet, safety goggles, safety gloves, safety footwear, hearing protection.



Only qualified persons are allowed to be present during use of pneumatic plugs. All third parties must keep away from the site. If there is an additional risk to people and the environment, take all necessary measures to minimize it.



When working in pipelines, shafts or indoors, provide for adequate ventilation. If this cannot be ensured by natural ventilation or if hazardous substances are released into the air during work, a technically regulated ventilation or a self-contained breathing apparatus must be provided.



When working in pipelines, shafts or indoors at a depth of more than 1 m, make sure that at least one additional person is present to assure safety. Persons shall be positioned so that they can see each other at all times, or at least be able to communicate by calls.



Working in the dark is dangerous, even if it the installation and inflation of pneumatic plugs are simple. Make sure that the place of use is adequately illuminated, not in the dark or shaded. Do not use an open flame for lighting in the dark.



The product may only contact surfaces whose temperature does not exceed the temperatures specified in the table below. The minimum temperature up to which the pneumatic plug maintains its sealing capability in the pipe, in which it is inserted, is given in the table below.



The standard design of pneumatic plugs **is not** suitable for use in potentially explosive atmospheres. Dedicated pneumatic plugs of special design are available for such use. Please contact the manufacturer for more information on specially designed plugs.



Pneumatic plugs are resistant to certain types of chemicals. To be able to select the right plug for a specific application, please refer to the attached Rubber Resistance Table or consult the manufacturer.

The permitted temperature range for the use of pneumatic plugs, depending on the type of material, is given in the table below.

Table 3:

	PRODUCT	OPERATING TEMPERATURE RANGE	TEMPERATURE, LOWER THAN PERMITTED	TEMPERATURE, HIGHER THAN PERMITTED
	PLUG(S)Y NR/BR	-20 to +80 °C	-40 to -20 °C max 1 h	80 to 100 °C max 30 min
	PLUG(S)Y CR	-15 to +80 °C	not permitted	80 to 100 °C max 30 min
	PLUG(S)Y NBR	-15 to +80 °C	not permitted	80 to 100 °C max 30 min
	CONE PLUG(S)Y, PLUGSY B-VP, PLUGSY VJ	-20 do +40 °C	-40 to -20 °C max 1 h	not permitted



## 5.4. CARRYING OF PRODUCTS

Carry pneumatic plugs upright or horizontally. Make sure that the inflation connector always faces upwards to avoid damage in the event of a fall.

Products weighing up to 20 kg can be carried by one person. Products weighing between 20 and 40 kg should be carried by at least 2 persons. Products heavier than 40 kg should be carried by means of appropriate accessories; these products are equipped with eyebolts for handling with hoists.



Eyebolts may only be loaded in certain directions. The angle of loading must not exceed 45° to the axis of the eyebolt.

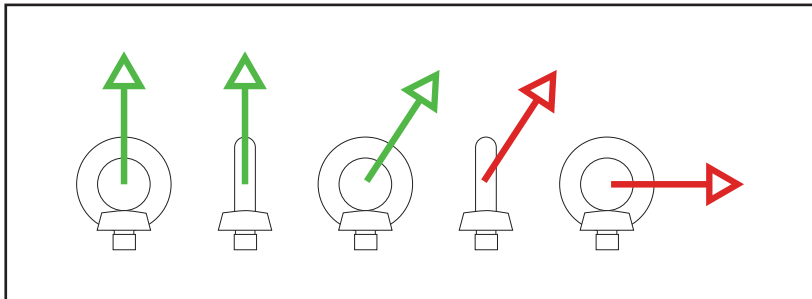

Figure 2: Permitted load directions for eyebolts

## 5.5. PACKAGING

Pneumatic plugs with a nominal diameter of less than 1000 mm are packed in cardboard packaging with a special protection for their sensitive parts. Pneumatic plugs with a nominal diameter of more than 1000 mm may be packed in wooden crates.



When removing packaging, do not use sharp objects such as knives, screwdrivers, etc., to prevent injuries and/or damage to the product.



To reduce the volume of packaging, pneumatic plugs may be shipped in completely deflated state. Once such a plug is removed from packaging, allow it to inflate on its own with air via the connector on the inlet coupling to assume its proper shape and/or up to its minimum nominal diameter at the most. If necessary, inflate it slightly. Be careful not to exceed the minimum nominal diameter of the plug.



The packaging is made of cardboard or wood and thus partially recyclable. Dispose of waste cardboard packaging in paper or cardboard packaging containers. Dispose of waste wooden crate in wood waste.

## 5.6. STORAGE AND PROTECTION OF PRODUCTS NOT IN SERVICE

Store only clean pneumatic plugs which have been proven to be technically and safety compliant.



Store pneumatic plugs that are not in service in a dry and dark space.  
**The storage temperature should be from +5 to +25°C.**



We recommend that pneumatic plugs are stored horizontally or upright with inflation connectors facing upwards. Protect the plug's inflation connectors, eyebolts and bypass tubes against mechanical damage.



We recommend that you coat the cleaned plugs with glycerine after use and before storage.

## 5.7. USE OF SAFETY SUPPORT

Because the back pressure may build up behind the pneumatic plug and cause it to move uncontrollably, a properly designed safety support must be installed. The safety support must be designed to resist 1.5 times the expected back pressure (example: if the back pressure generates a force of 10,000 N, the safety support must be able to resist a force of at least 15,000 N in the axial direction). If using a reusable safety support, consider the manufacturer's instructions (e.g. installation, removal, etc.).



Failure to install a safety support can be life-threatening. Do not use eyebolts or handles of the pneumatic plug to install the support, as these are intended solely for lowering and lifting the pneumatic plug.

## 5.8. CHOOSING THE RIGHT PNEUMATIC PLUG

### 5.8.1. BASED ON PIPE DIAMETER

Before using a pneumatic plug, measure the inner clear diameter of the pipe into which the pneumatic plug will be inserted. Make sure that the diameter of the pipe corresponds to the usage range of the plug.

For each pneumatic plug, lower and upper usage ranges are specified. The nominal size of the pneumatic plug or the usage range, in which the pneumatic plug can be used, are clearly marked on each plug.

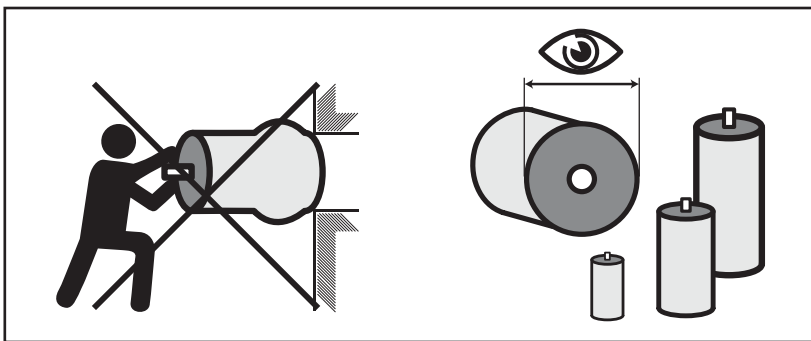

Figure 3: Choosing the right plug based on pipe diameter



Never use a pneumatic plug in a pipe whose diameter is smaller or larger than the usage range of the plug.

### 5.8.2. BASED ON MEDIA RESISTANCE



To select the right pneumatic plug based on its media resistance features, one first has to be familiar with the medium to which the outer surface of the pneumatic plug and its bypass tube will be exposed during use;

however, the duration of exposure, the temperature and the concentration of the medium are also important. The resistance of a pneumatic plug to different media is determined according to the ISO/TR 7620 standard.

To select the right plug for the medium you are using, please refer to the enclosed Rubber Resistance Table or consult the manufacturer.

Roughly speaking, the plugs consist of different outer rubber layers as shown in the table below. The plugs are labelled with a corresponding colour code on their top side.

Table 4:

PRODUCT	OUTER RUBBER LAYER	COLOUR CODE ON THE PLUG
PLUG(S)Y NR/BR	NR/BR rubber	
PLUG(S)Y CR	CR rubber	

### 5.8.3. BASED ON THE EXPECTED BACK PRESSURE



Before choosing the pneumatic plug, determine the back pressure the plug must be able to resist during use.

The back pressure is the pressure with which the medium in the pipeline acts on the inserted pneumatic plug. The effect of the back pressure can be very strong and should be assessed for each individual use of the pneumatic plug. Excessive back pressure can cause uncontrolled movement of the pneumatic plug and, in extreme cases, its failure.



The back pressure values given in the enclosed technical data tables for pneumatic plugs apply to the plugs used in dry metal pipes.

There are several ways of assessing the back pressure, one of which is to first assess the length of the pipeline downstream of the plug and then, based on the pipeline's slope, the back pressure value behind the plug.

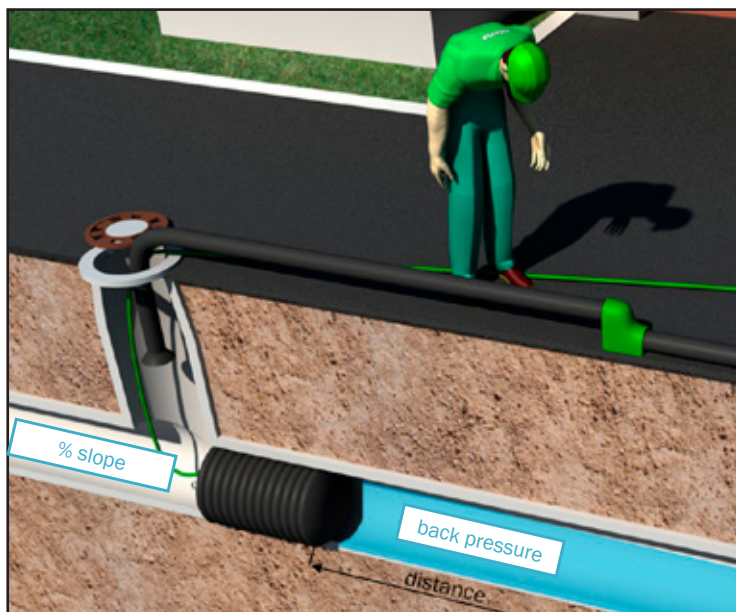

Figure 4: Determination of the expected back pressure for a known pipeline slope

Example: A 300 m long pipeline with a slope of 1%.

$$\text{height difference [m]} = \frac{\text{pipeline length [m]} \times \text{slope [\%]}}{100\%} = \frac{300 \text{ m} \times 1\%}{100\%} = 3 \text{ m}$$

The calculation according to the above equation proves a height difference of 3 m in the pipeline. Based on knowledge of the hydrostatic pressure, it can be concluded that the given height difference will cause a back pressure of 0.3 bar.



Regardless of the pipe's shape, a back pressure of 1 bar builds up in a 10 m high pipe filled with water.

Dirt in the pipes (algae, grease, detergents, mould, sand, etc.) can significantly reduce the back pressure value.

In pipes made from materials with lower coefficients of friction, e.g. polyethylene pipes or new pipes with residual grease or other agents, friction is lower and consequently also the back pressure of the pneumatic plug.

Should you have any difficulties or questions regarding the determination of the back pressure, please consult the supervisor or the safety engineer in charge at the site.

#### 5.8.4. BASED ON THE TOTAL FORCE RESULTING FROM THE BACK PRESSURE

During the use of a pneumatic plug in a pipeline, enormous forces can build up in and behind the plug. The total force acting on the pneumatic plug is proportional to the pressure and the area of the pipe opening in which the pneumatic plug is inserted. To choose the right pneumatic plug based on the expected back pressure refer to technical data about the plug.

The following quick calculation can be used in assessing the force acting on the plug due to the back pressure:

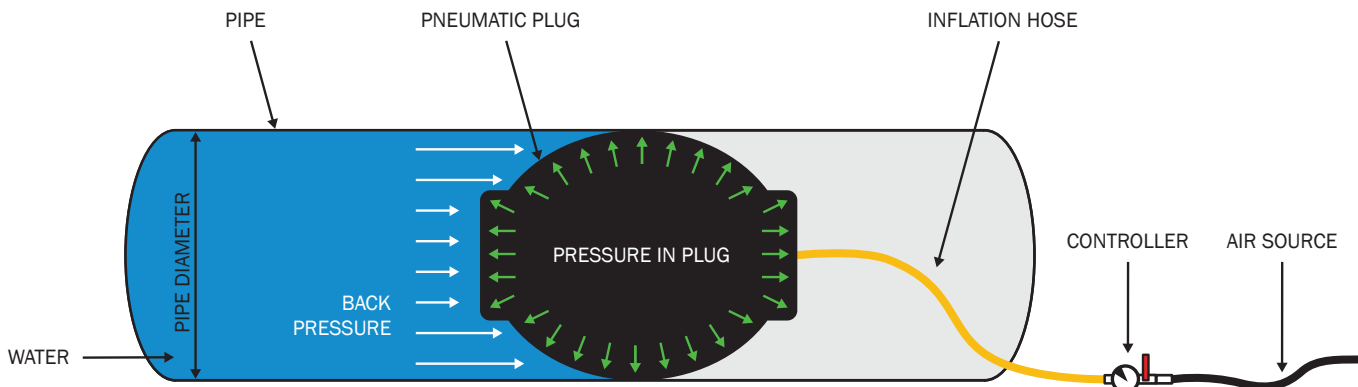

- calculation of pipe surface:  $A = \pi \times \frac{D^2}{4}$  [cm<sup>2</sup>];
- calculation of force:  $F = p \times A \times 10$  [N] =  $p \times (\pi \times \frac{D^2}{4}) \times 10$  [N];

Where:

D = the inner clear pipe diameter [cm],  
 A = the surface of the pipe clear diameter [cm<sup>2</sup>],  
 p = the estimated back pressure [bar], and  
 F = the total force acting on the plug [N].

Example:

The inner clear diameter of the pipe is 50 cm. The height of the water column behind the plug is estimated at 5 m.

$$F = p \times (\pi \times \frac{D^2}{4}) \times 10 \text{ [N]} = 0,5 \times (3,14 \times \frac{50^2}{4}) \times 10 = 9810 \text{ N}$$

The calculated total force acting on the plug is 9810 N.



The calculated force is an approximate estimate and is not a guarantee for the calculation of the actual course of force action in the plug.

## 6.0. PRODUCT IDENTIFICATION

### 6.1. PRODUCT DESIGNATION

Each product is labelled with the usage range and the prescribed working pressure. It is also marked with a serial number indicating the age of the plug. A QR code is part of the serial number.

#### 6.1.1. PRODUCT CODES

Each product is labelled with the usage range and the prescribed working pressure, usually on the face surface of the cylindrical plug next to the inflation connector and/or inlet coupling. The inscription is not erasable; it consists of the minimum and maximum diameter of the pipeline for which the pneumatic plug is designed. The

prescribed working pressure is indicated in bar. The usage range and the working pressure are also given in inches and PSI for product use in areas with different units of measurement.

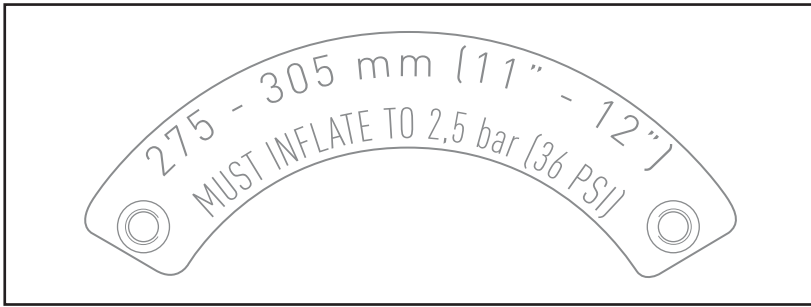

Figure 6: Example of plug designation

With other types of plugs, the usage range and the maximum inflation pressure are clearly and visibly marked, usually near the inflation connector. A special label with all details is also possible.

### 6.1.2 SERIAL NUMBER DATA

The serial number is usually located on the cover of the pneumatic cylindrical plug; it consists of a number and a QR code. The first two digits in the number represent the month of manufacture and the following two the year of manufacture of the plug, while the remaining digits represent the sequence number of the manufactured plug. In the bottom row of the serial number, m (month) stands for the month of manufacture and y (year) the year of manufacture. The QR code is a graphic image of the serial number.



Figure 7: Example of a serial number

With other types of plugs, the serial number is clearly visible on the pneumatic plug, usually near the inflation connector and/or inlet coupling.

On older products, the serial number may be formatted differently. In the past, the following markings were used:



Figure 8: Example of an older serial number

With certain products, the serial number represented a batch and as such it consisted of three or four digits, separated by a dot. The digit or digits before the dot stand for the week of manufacture, the other two digits for the year of manufacture.



Figure 9: Example of a batch serial number

## 6.2. LIFETIME

The expected lifetime of the product, if properly used and maintained, is 15 years.



Pneumatic plugs are made from rubber and thus subject to natural ageing. Although visual inspection shows the pneumatic plugs are still in good condition, they should be removed from service after 15 years from the year of manufacture, as signs of ageing, invisible to the naked eye, may already be hidden in the structure of the material.

Destructed or damaged products or products that have reached the end of their useful life must be removed from service. They should not be disposed of as ordinary waste as they are considered returnable waste. Classification should be carried out in accordance with locally applicable regulations.



The product can be partially recycled.

## 7.0. COMPONENTS OF THE PNEUMATIC PLUG SYSTEM

### 7.1. PNEUMATIC PLUG SYSTEM

When using the plugs, always follow the combination shown in the picture below to ensure safety of the entire system and to prevent the plug from inflating beyond the permitted working pressure.



Figure 10: Pneumatic plug system



Pneumatic plugs can only be inflated with compressed air. In special cases, water is allowed for filling. The use of other media is not permitted.



The inflation of pneumatic plugs without using controllers with built-in safety valves is not permitted.

### 7.2. AIR SOURCE

Any air source that does not exceed the maximum inlet pressure of the controller can be used for pneumatic plug inflation. If the inlet pressure of the source is higher, be sure to use a pressure regulator. Oil vapours inside a pneumatic plug can cause permanent damage which may eventually lead to the destruction of the product; if the air source contains oil, use an oil separator.



The user is fully responsible for the proper and safe preparation of the air source so that it does not exceed the maximum inlet pressure of the controller.

### 7.2.1 ORDINARY AIR SOURCES

Ordinary air sources include compressors, pressure vessels, hand and foot pumps. Each air source has its own specifics and is not suitable for every plug.

### 7.2.2. DIFFERENT ADAPTERS

Depending on the air source, adapters for filling of pneumatic plugs via different systems are available as accessories. Please contact your local dealer or the manufacturer if you wish to purchase one.

## 7.3. CONTROLLER

The controller is a dedicated pneumatic element designed to safely fill, discharge and control the medium in the pneumatic plug. It consists of an inlet safety coupling (A), a ball valve (B), a pressure gauge (C), a safety valve (D) and an outlet connector (E), as shown in the figure below. All components and their functions are described further below.

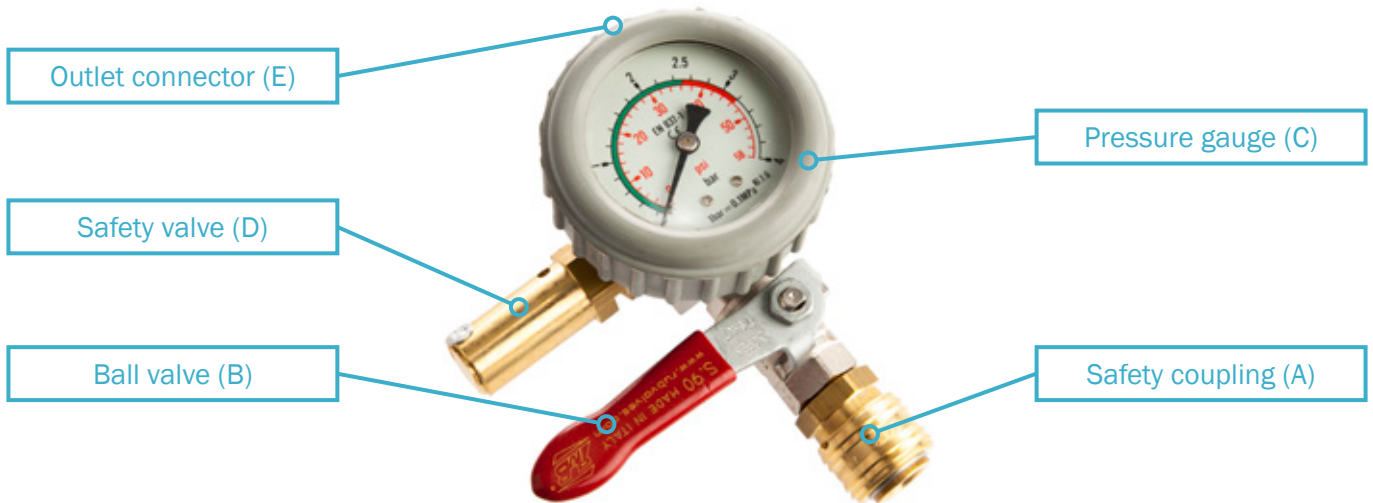
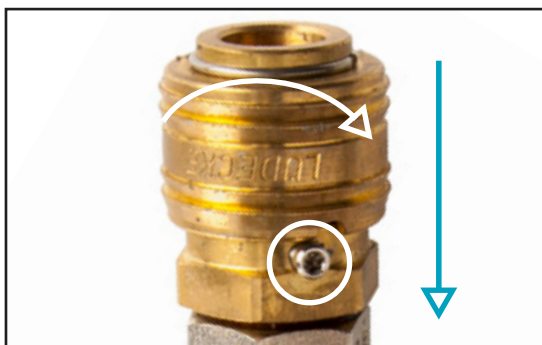

Figure 11: Components of the controller



The controller must be connected to the plug throughout the inflation of the pneumatic plug and when the plug is under pressure. For longer operation, the pressure in the plug must be periodically checked.

### 7.3.1. DESCRIPTION OF THE CONTROLLER COMPONENTS



The inlet coupling of the controller (A) is routed via the air hose to connect the air source to the controller. The coupling has a safety feature that prevents its unintentional disconnection. No special attention is required for the connection of the air hose. Only make sure that the air hose connector snaps into the coupling. However, to disconnect the air hose, turn the safety ring of the coupling until the notch on the ring engages with the screw on the coupling, as shown in the figure below. When pushing the ring downwards, as shown by the blue arrow in the figure below, the air hose connector can be pulled out of the coupling.

Figure 12: Safety coupling



The ball valve (B) allows air inlet into the pneumatic plug.

The controller pressure gauge (C) monitors the pressure in the pneumatic plug. The green marked scale on the pressure gauge stands for the permitted pressure range of the pneumatic plug. The value of the working pressure is indicated at the end of the green field.



The actual pressure value in the pneumatic plug can only be read when the ball valve of the controller is closed. It is forbidden to use pneumatic plugs within the red-marked pressure range or above it.

For additional safety, a safety valve (D) is fitted on the controller. The factory pressure setting is 1.1 times the working pressure and cannot be modified. If the working pressure in the pneumatic plug is exceeded, the safety valve is mechanically activated to immediately start reducing the pressure in the pneumatic plug.



The activated safety valve makes a strong and characteristic sound. If the safety valve is activated, the user must immediately close the ball valve to stop the inflation of the pneumatic plug.

The flow capacity of the safety valve upon activation is limited. With a high flow capacity air sources it may happen that the inflation of the pneumatic plug does not completely stop, but only slows down. This usually happens with larger size plugs.

The outlet connector (E) on the controller serves for connection of the connecting hose between the controller and the pneumatic plug.

### 7.3.2. INFLATING THE PNEUMATIC PLUG

To fill the pneumatic plugs, open the ball valve on the controller. The ball valve is open when the valve lever is parallel to the safety coupling, at which the safety valve must be closed. The pneumatic plug is now being inflated at a speed which is not uniform. When the plug is inflated up to the working pressure, close the ball valve.



Initially, the plug inflates relatively “slow”. The closer the plug is to the diameter of the pipe, the faster the pressure in the plug increases. Towards the end of the procedure, check inflation more often. Avoid the situation of exceeding the working pressure in the pneumatic plug.

### 7.3.3. EMPTYING THE PNEUMATIC PLUG



Before deflating the pneumatic plug, make sure that the back pressure behind the plug is completely released.



Before deflating the pneumatic plug, disconnect the air hoses from the controller and carefully open the ball valve. Start to empty the pneumatic plugs via the controller by unscrewing the protective screw on the safety valve of the controller, as shown in the figure below. After emptying is complete, retighten the protective screw on the safety valve.

Figure 13: Deflating the plug via the controller

## 7.4. INFLATION HOSES

Air and connecting hoses form the inflation hose system of the pneumatic plug. Always use pressure and dimension-suitable inflation hoses of suitable. To prevent improper use, standard connecting hoses are fitted with different types of connectors and couplings.

## 8.0. USE OF PNEUMATIC PLUGS

The work procedure is described using the example of a cylindrical pneumatic plug; follow the steps in the order given.



When, during the use of the pneumatic plug, unexpected situations arise, stop work immediately and consult the supervisor or safety engineer in charge; they will determine the necessary measures and additional cleaning of the pipe, if required, before the inserting the pneumatic plug.

### 8.1. INSERTING THE PNEUMATIC PLUG INTO THE PIPELINE

#### STEP 1:

Measure the diameter of the pipe, check the medium to which the plug will be exposed, determine the expected back pressure in the pipeline and select the right pneumatic plug.

#### STEP 2:

Thoroughly inspect and prepare the pneumatic plug, air source, controller and inflation hoses at the site. All equipment must be clean. The pressure gauge on the controller should be calibrated periodically. Check the pneumatic plug for tears, cuts, air pockets between the rubber layers, worn metal parts, damaged connectors or any other damage.

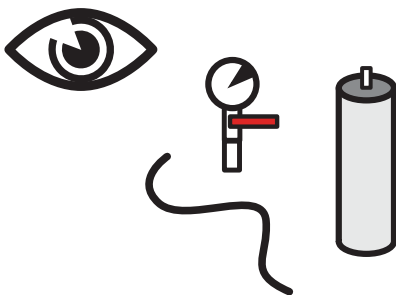

Damaged products or accessories are dangerous to use and should be removed from service and replaced.



In case of any doubts about safe use of the pneumatic plug and the accessories, discontinue work, remove the equipment and consult the safety engineer in charge on further use.

Figure 14: Equipment overview

#### STEP 3:

Properly clean the pipe before inserting the pneumatic plug. Remove all dirt and any sharp particles to ensure proper sealing of the pneumatic plug and prevent damage to it. We recommend using a high-pressure water cleaner to clean the pipeline. For additional protection, we recommend the purchase and use of protective sleeves. For more information on protective sleeves, please contact the manufacturer.

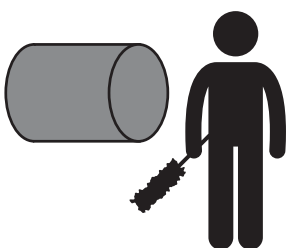

Even small particles in an uncleaned pipe can cause leaks, reduce the back pressure and permanently damage the pneumatic plug.

Figure 15: Cleaning the pipe

#### STEP 4:

Insert the pneumatic plug into the pipe so that it is positioned horizontally and in the middle of the pipe cross-section. The shortest distance from the beginning of the pipe to the pneumatic plug should be at least equal to the diameter of the pipe in which the plug is inserted. Some versions of pneumatic plugs (mainly non-reinforced plugs) also extend longitudinally when inflated.

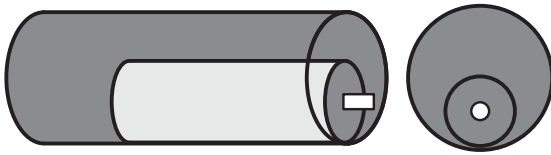

Figure 16: Insertion of the plug into the pipe

Incorrect positioning of the pneumatic plug can result in improper distribution of forces in the plug, which can lead to permanent damage to the plug.



- Do not inflate the pneumatic plug outside the pipe.
- Do not inflate the pneumatic plug in an uncleaned pipe.
- Pneumatic plug must be fully inserted in the pipe.
- Pneumatic plugs are intended for use in straight pipes only.

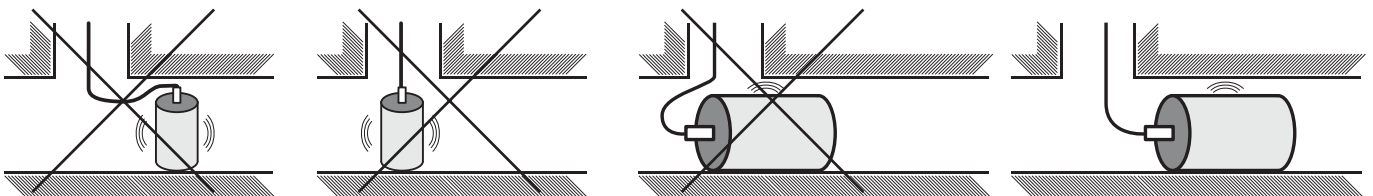

Figure 17: Improper insertion of the plug into the pipe

#### STEP 5:

When using the pneumatic plug, also install a suitable safety support. Make sure that in the event of an unexpected situation, the safety support will safely and completely prevent the pneumatic plug from moving.

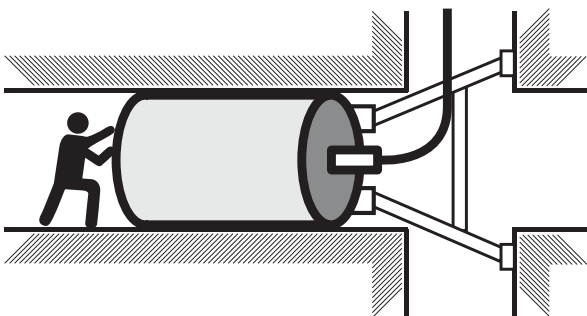

Figure 18: Installation of safety support



- Failure to use the safety support can be life-threatening. Do not use the eyebolts or handles on pneumatic plugs to fasten the support; these are intended solely for lowering and lifting of pneumatic plugs.

**STEP 6:**

Using the connecting hose, connect the pneumatic plug and the controller.

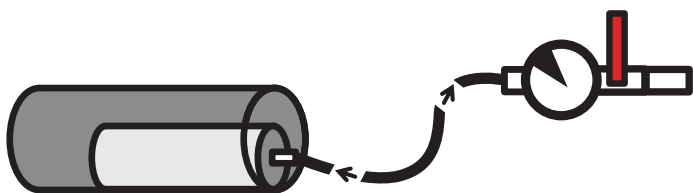

Figure 19: Step 6

**STEP 7:**

Using the air hose, connect the controller and the air source.

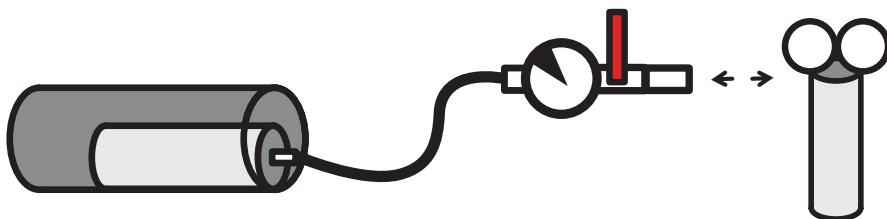

Figure 20: Step 7

**STEP 8:**

Check the air source pressure.

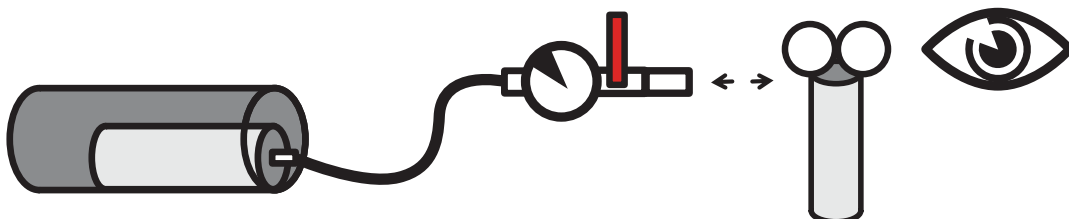

Figure 21: Step 8

**STEP 9:**

Open the ball valve on the controller and start to inflate the plug.

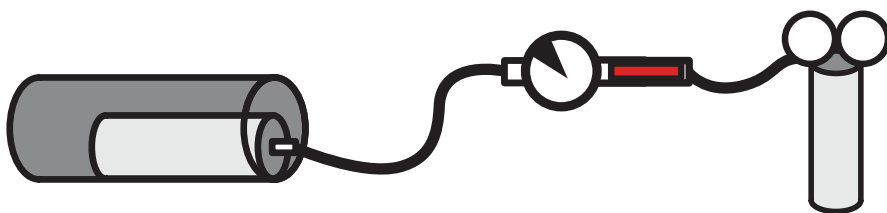

Figure 22: Inflating the plug



The position of the pneumatic plug in the pipe may change during inflation, therefore keep checking it and adjust if necessary. Incorrect positioning of the pneumatic plug may lead to improper distribution of forces in the plug, resulting in permanent damage to the plug.



When the plug fully contacts the inner surface of the pipe and is pressurized, it is strictly forbidden to stay in the danger zone (near the pneumatic plug, in the manhole or shaft in which the plug is inserted). Failure to observe these instructions may result in injuries or even death.

**STEP 10:**

Check the pressure in the plug at intervals, which should become shorter with reducing the difference between the working pressure and the actual pressure in the pneumatic plug. Note that the actual pressure can only be read with the controller ball valve closed. Initially, the plug inflates relatively “slowly”. The more the plug size gets closer to the diameter of the pipe, the faster the pressure in the plug increases.

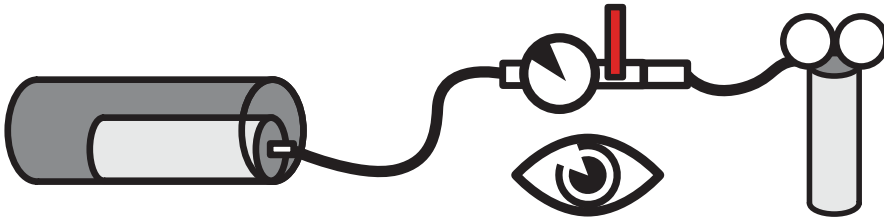

Figure 23: Checking the pressure in the pneumatic plug

**STEP 11:**

When the working pressure in the pneumatic plug is reached, close the ball valve on the controller. When inflation is complete, a slight drop in plug pressure may be noticed, which is normal due to stretching of the pneumatic plug structure and it stops after a while. One minute after the pneumatic plug reaches the prescribed value, check the pressure and refill it if necessary.

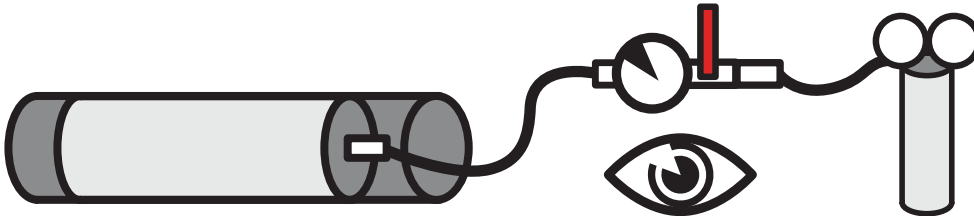

Figure 24: Inflated plug

If the plug is in service for a longer period of time, check the pressure at least every five hours; if it drops, re-inflate the plug. Throughout the inflation, the use of the pneumatic plug and when the plug is pressurized, the controller must be connected to the plug.



Do not exceed the permitted working pressure in the pneumatic plug.  
A too low pressure in the pneumatic plug may result in a back pressure drop.

## 8.2. REMOVING THE PNEUMATIC PLUG FROM THE PIPELINE

**STEP 1:**

Close the valve on the air source inlet and disconnect the air hose.

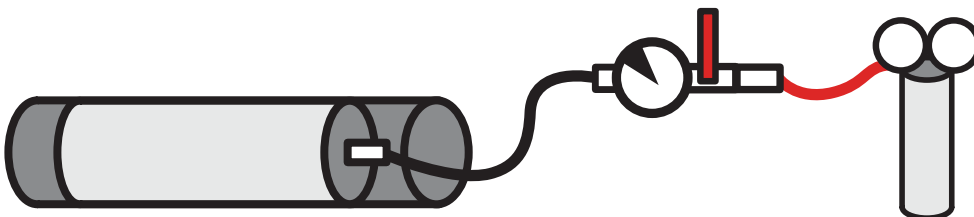

Figure 25: Air hose disconnection

Release the back pressure behind the plug and check if it is released.

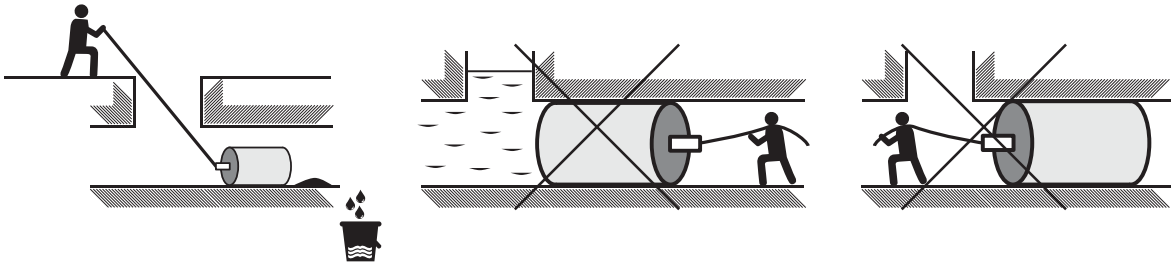

Figure 26: Back pressure release



Before deflating the pneumatic plug, make sure that any back pressure behind the plug is released. Deflating the plug with back pressure present can be life-threatening.

**STEP 2:**

Release all air from the pneumatic plug until the pressure in the plug equals the atmosphere pressure and the plug assumes its original non-inflated shape.

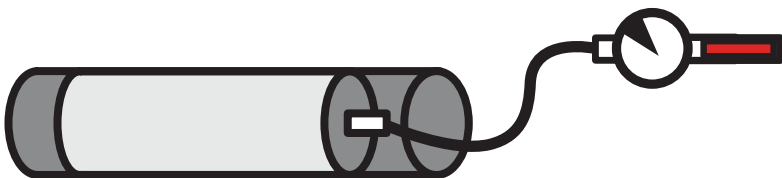

Figure 27: Air release from the plug

**STEP 3:**

Disconnect the connecting hose and the controller.

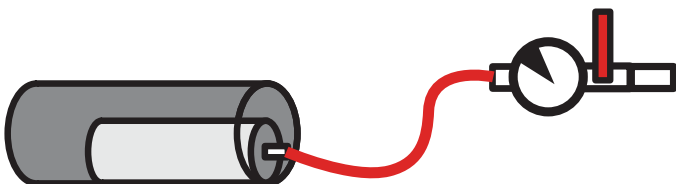

Figure 28: Connecting hose disconnection

**STEP 4:**

Remove the pneumatic plug from the pipe.



Figure 29: Plug outside the pipe



Do not pull on the inflation hoses to remove the pneumatic plug from the pipe. Doing so may damage the inflation hose or the plug, making further work dangerous. Use handles or eyebolts for pulling.

## STEP 5:

After use, clean and store the pneumatic plug and the accessories used. Follow the instructions for use.

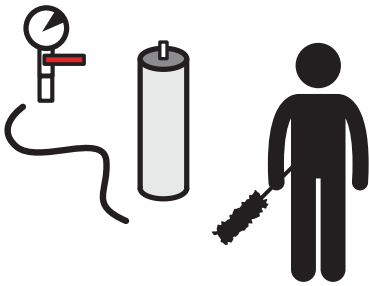

Figure 30: Cleaning of equipment

After cleaning, thoroughly inspect all equipment. Check it for any tears, cuts, air pockets between rubber layers, worn metal parts, damaged connectors or any other damage.



Damaged products or equipment are dangerous to use and should be removed from service and replaced.

Should there be any doubt about the safe use of the pneumatic plug and equipment, discontinue work, remove the equipment and consult the responsible safety engineer on further use.

## 9.0. POSSIBLE USES OF PNEUMATIC PLUGS

There are roughly three main areas where pneumatic plugs can be used: temporary sealing of pipelines, temporary bypassing and testing of pipeline. As pneumatic plugs differ from one another, the way of their use for the same purpose also varies. Specific situations are described below, however, details are not covered in full.



Follow the instructions for use when working with pneumatic plugs.

Use safety supports during use.

Pay particular attention to safety instructions.

### 9.1. TEMPORARY SEALING OF PIPELINES WITH PNEUMATIC PLUGS

There are two options for temporary sealing of pipelines with pneumatic plugs, depending on the back pressure, which can be negligible or stable, or variable.

#### 9.1.1. SEALING OF PIPELINES WITH NEGLIGIBLE OR STABLE BACK PRESSURE



For temporary sealing of pipelines with pneumatic plugs where negligible back pressure is expected or the back pressure is known and does not vary with time, we recommend using PLUGY blocking plugs.

Figure 31: Inserted blocking plug





Blocking plugs do not allow real-time control and release of back pressure, which is why special care is needed in estimation or calculation the expected back pressure, in selection of the right family and size of blocking plugs, preparation of the insertion site and the use of the plug.

PLUGSY bypass plugs can be conditionally used for temporary pipeline sealing. In this case, the bypass tube is to be sealed with a corresponding mechanical stopper. Install a valve with a pressure gauge indirectly via a suitable hose on the bypass tube of the plug. The valve allows the back pressure to be controlled and released in case it rises.



PLUGSY VP pneumatic plugs are not suitable for temporary sealing of pipelines with back pressure.

### 9.1.2. SEALING OF PIPELINES WITH VARIABLE BACK PRESSURE

Use PLUGSY bypass plugs for temporary sealing of pipelines, where variable back pressure values are expected and the permitted values could be exceeded.

Using a suitable hose, install a pressure gauge to the bypass tube of the plug to control the back pressure and a valve for its release. Throughout the use of the pneumatic plug, monitor the back pressure value. Open the valve to release the back pressure before it reaches 80 % of the limit value.

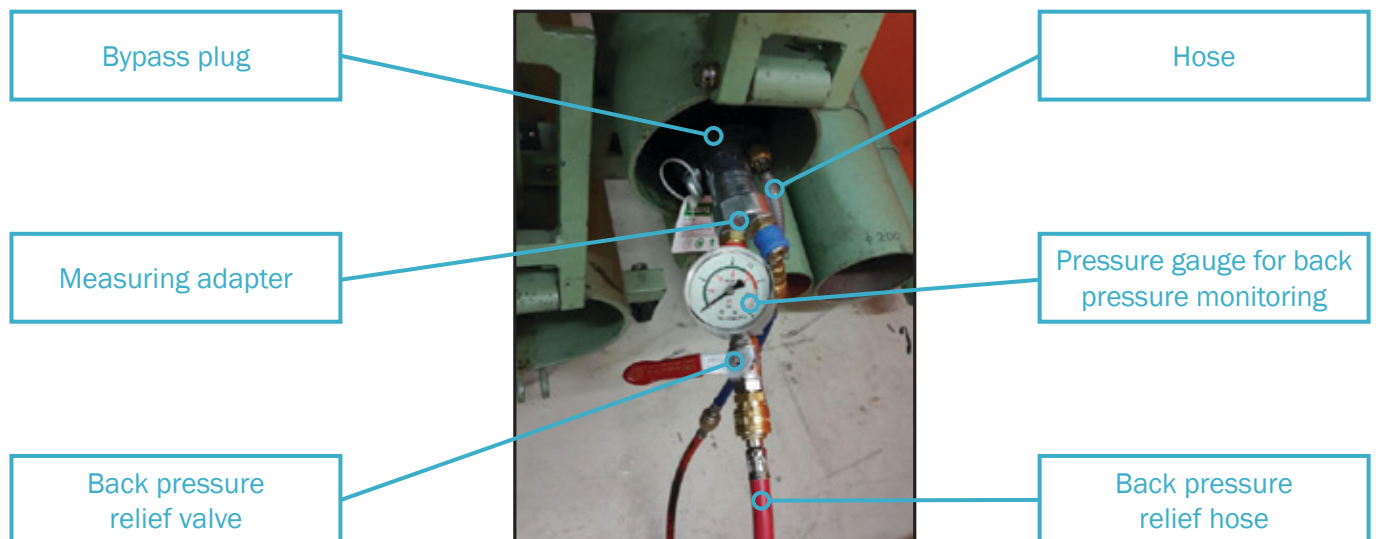

Figure 32: Installed bypass plug with accessories for back pressure control and release



Do not reduce the pressure in the pneumatic plug until the back pressure is completely released.



Pneumatic plugs PLUGSY VP are not suitable for temporary sealing of pipelines with back pressure.

## 9.2. PREPARATION OF A BYPASS WITH PNEUMATIC PLUGS

### 9.2.1. PREPARATION OF A TEMPORARY BYPASS WITH PNEUMATIC PLUGS

A bypass with plugs usually diverts the flow between two manholes of a pipeline. Use a blocking and a bypass pneumatic plug to create a temporary bypass. Insert the bypass plug into the pipe upstream of the first manhole. Connect a bypass hose to the bypass tube of this plug and rout it via the pump to the second manhole. Insert the blocking plug in the second manhole to prevent the medium from entering the pipeline. The medium that will flow to the bypass pneumatic plug will be pumped via the pump and the bypass hose to the second manhole. In this way the pipeline between the two plugs will remain dry.

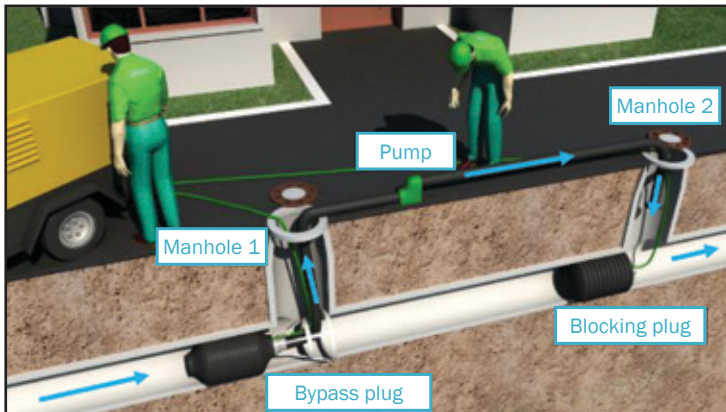

Figure 33: Preparation of a bypass with pneumatic plugs

Where larger flows are required and high back pressure is not expected, dedicated PLUGSY VP bypass plugs can be used. These allow larger volumes of media to flow through the bypass tube, namely between 1/8" to 8".



Using PLUGSY VP pneumatic plugs as an alternative to pneumatic blocking plugs is not permitted.

## 9.3. TESTING WITH PNEUMATIC PLUGS

### 9.3.1. USE OF PNEUMATIC PLUGS FOR TESTING ACCORDING TO THE EN 1610 STANDARD

Pneumatic plugs are suitable for leak testing of pipelines and sewers in accordance with the EN 1610 standard, Section 12.2. Provided the right equipment is chosen, the plugs can be tested in both ways (air L, water W).

Depending on the test chosen and the size of the pipeline, several test systems are available, consisting of different blocking and bypass plugs and the accessories. They can be roughly divided into three groups.

#### **Pipeline leak test:**

To carry out an air leak test, combine a PLUGSY bypass plug and a PLUGY blocking plug; install them as shown in the figure below.

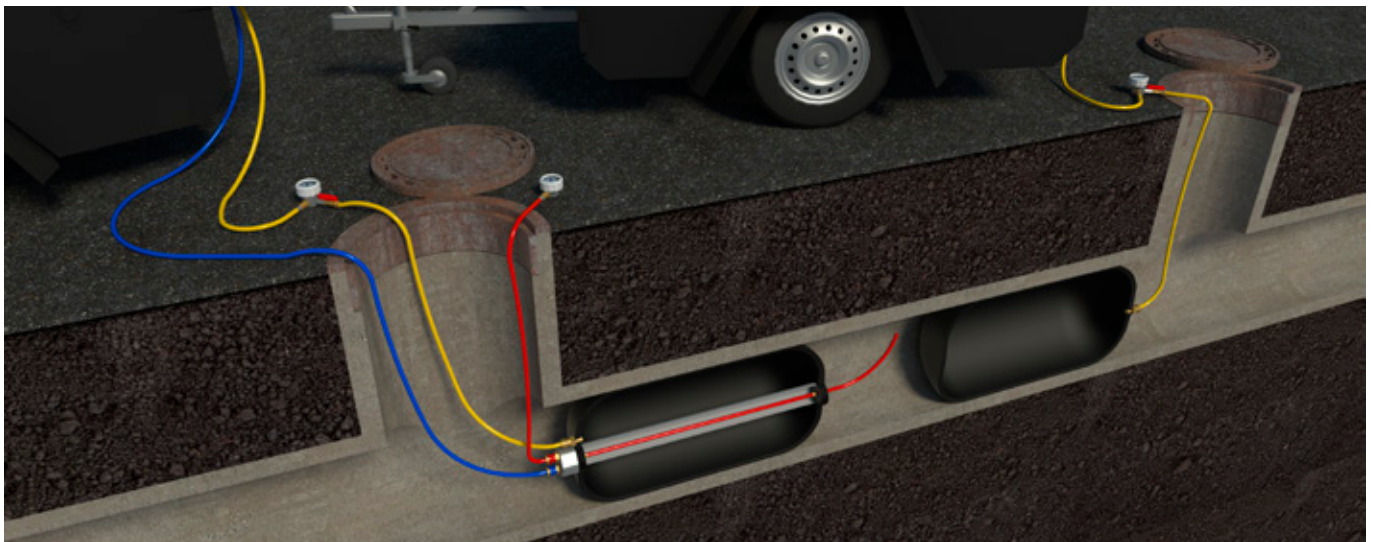

Figure 34: Air leak test of pipelines

To carry out a water leak test, combine two PLUGSY bypass plugs; install them as shown in the figure below.



Figure 35: Water leak test of pipelines

**Gully leak test:**

Combine a PLUGSY VJ bypass plug and two blocking plugs; install them as shown in the figure below. (An example of a gully leak test is described in the attachment.)



Figure 36: Gully leak test



### Leak test of house sewage drains and pipes:

To perform an air leak test, use a house connection leak test kit consisting of bypass and blocking plugs, and the accessories and allowing both air and water leak tests. (An example of a house connection leak test is described in the attachment.)



Figure 37: House connection leak test



Before carrying out any tests, please read the instructions for use of the products. Pay special attention to safety instructions.

### 9.3.2. HAND-HELD DIGITAL PRESSURE GAUGE FOR AIR LEAK TEST

Use a calibrated pressure gauge with sufficient measurement accuracy for air leak testing of pipelines in accordance with the EN 1610 standard. We recommend that you use a digital hand-held pressure gauge, as shown in the figure below. This is a calibrated digital pressure gauge with a resolution of 0.1 mbar and a measuring range between -10 and 350 mbar. The measuring connection is fitted with a standard connector for pneumatic plugs.



Figure 38: Hand-held digital pressure gauge

The pressure gauge and more information about the product can be obtained from the manufacturer.

## 10.0. FAULT IDENTIFICATION AND UNEXPECTED SITUATIONS

When working with pneumatic plugs, you may be confronted with faults and unexpected situations. Some of them are described below along with possible consequences and the actions necessary











Follow all known safety instructions in dealing with the consequences of faults and unexpected situations.



In the event of a product rupture, a very loud bang is heard.

Table 5:

UNEXPECTED SITUATION	CONSEQUENCE	NECESSARY ACTION
<p>The pressure in the pneumatic plug starts to fall uncontrollably and steadily.</p> <p> A small pressure drop is a normal consequence due to stretching of the plug structure during inflation.</p>	<p>Uncontrolled and dangerous moving of pneumatic plug due to the exceeded back pressure.</p> <p>Damage to the plug.</p>	<p> A properly installed safety support can prevent injury to persons and damage to objects.</p>
<p>Short slipping of the pneumatic plug due to the exceeded back pressure.</p>	<p>Uncontrolled and dangerous movement of the pneumatic plug due to the exceeded back pressure.</p> <p>Damage to the plug.</p> <p> The pneumatic plug is about to slip. <b>STAYING IN THE DIRECTION OF THE PIPE WITH THE PLUG INSERTED IS LIFE-THREATENING!</b></p>	<p>Immediately start to release the back pressure.</p> <p> A properly installed safety support can prevent injury to people and damage to objects.</p>
<p>The ball valve on the controller cannot be closed.</p>	<p>The pressure in the pneumatic plug will increase, which can cause the plug to burst.</p> <p> The increase in pressure in the pneumatic plug will activate the safety valve, which will start to reduce the pressure in the plug, and/or in the case of an air source with excessive capacity, it will slow down the inflation.</p>	<p>Immediately close the air source.</p> <p>If back pressure has built up, start to release it.</p> <p> A properly installed safety support can prevent injury to people and damage to objects.</p> <p>Deflate the pneumatic plug.</p> <p>Replace the controller.</p>
<p>The safety valve on the controller is activated.</p>	<p>In the case of a high-capacity air source, the safety valve will not interrupt the inflation but only slow it down.</p>	<p>Immediately stop inflating the pneumatic plug and reduce the pressure down to the specified value.</p>
<p>The pressure gauge on the controller fails to function while working.</p>	<p>Safe use of the pneumatic plug is compromised.</p>	<p>Start deflating the pneumatic plug.</p> <p>Replace the entire controller.</p>
<p>Damage to the air hose during use.</p>	<p>Inflation of the pneumatic plug is disabled.</p>	<p>Start deflating the pneumatic plug.</p> <p>Replace the air hose.</p>
<p>Damage to the connecting hose during use.</p>	<p>Inflation of the pneumatic plug is disabled.</p>	<p>Start deflating the pneumatic plug.</p> <p>Replace the connecting hose.</p>
<p>The air hose cannot be properly inserted into the connecting coupling of the controller.</p>	<p>Dirt on the connector or coupling.</p> <p>The connector or coupling is damaged.</p>	<p>Clean the connector or coupling.</p> <p>Replace the air hose or controller.</p>
<p>The connecting hose cannot be properly inserted into the connecting coupling of the controller.</p>	<p>Dirt on the connector or coupling.</p> <p>The connector or coupling is damaged.</p>	<p>Clean the connector or coupling.</p> <p>Replace the hose or controller.</p>

UNEXPECTED SITUATION	CONSEQUENCE	NECESSARY ACTION
Although the ball valve on the controller is open, the pneumatic plug does not inflate.	<p>Failure of the safety valve.</p> <p>The protective screw on the safety valve is loose.</p> <p>The connector or coupling is clogged.</p> <p>The air or connecting hose is not properly connected.</p> <p>The air or connecting hose is damaged and fails to seal.</p>	<p>Replace the controller.</p> <p>Tighten the safety screw on the safety valve.</p> <p>Clean the coupling or connector.</p> <p>Check and reconnect the air or connecting hose.</p> <p>Re-insert the pneumatic plug into the pipe and inflate it.</p>
The pneumatic plug inserted in the pipe does not seal.	<p>Liquid leaks past the pneumatic plug.</p> <p>The pressure in pipeline test area drops due to poor sealing of the pneumatic plug.</p>	<p>Release the pressure in the pneumatic plug.</p> <p>Remove the pneumatic plug.</p> <p>Clean the contact surface between the pipe and the pneumatic plug.</p> <p>Re-insert the pneumatic plug into the pipe and inflate it.</p>
No flow through the bypass tube of the bypass pneumatic plug.	<p>The fluid flow is stopped.</p> <p>Pipeline test area cannot be filled with air or water.</p>	<p>Release the pressure in the pneumatic plug.</p> <p>Remove the pneumatic plug.</p> <p>Clean the contact surface between the pipe and the pneumatic plug.</p> <p>Re-insert the pneumatic plug into the pipe and inflate it.</p>
During emptying the pneumatic plug, the protective screw on the safety valve of the controller cannot be unscrewed.	The protective screw on the safety valve of the controller is mechanically blocked.	<p>Take extreme care when disconnecting the connecting hose from the controller.</p> <p>Replace the safety valve on the controller.</p> <p> The hose is pressurized and it may move uncontrollably when disconnected – there is risk of impact.</p>
<p>Even though the connecting hose of the pneumatic plug is disconnected, the pressure in the plug does not drop during deflation.</p> <p>The pneumatic plug cannot be emptied</p>	The connector on the connecting hose or the coupling on the pneumatic plug is clogged.	<p>Clean the connector of the connecting hose.</p> <p>Clean the coupling on the pneumatic plug.</p> <p> Do not enter the danger zone!</p>

## 11.0. ACCESSORIES

For certain pneumatic plugs, additional accessories are available for purchase and use. The list of accessories is attached. For more information, please contact your sales dealer or visit their website.

## 12.0. CLEANING OF PNEUMATIC PLUG SYSTEM

Clean and inspect the pneumatic plug and accessories after every use. During cleaning, always use protective equipment, which should include at least safety goggles, gloves and safety footwear.



## 12.1. CLEANING OF PNEUMATIC PLUGS

Use a stiff-bristled brush to remove adhering dirt from the surface of the pneumatic plug. Move the brush in different directions. Once all adhering dirt is removed, soak the stains on the pneumatic plug with a mild solution of dishwashing detergent and warm water, and remove remaining dirt from the surface with a stiff-bristled brush. Do not use petrol, thinner, alcohol or aggressive cleaning agents.

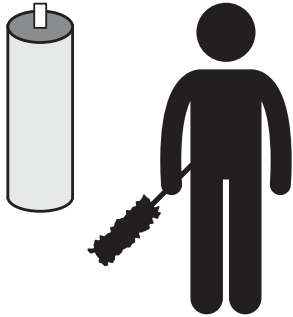

Figure 39: Cleaning of pneumatic plugs

Rinse the pneumatic plug with clean cold water. A strong jet of water will remove any remaining dirt and soapy water that may have remained on the surface of the pneumatic plug.

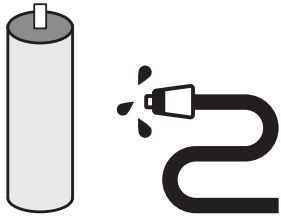

Figure 40: Cleaning of pneumatic plugs



The use of sharp objects to remove dirt is not allowed.



Do not use solvents, hydrocarbons and other aggressive agents for cleaning the pneumatic plugs. The use of such agents can permanently damage or even destroy pneumatic plugs.

Allow the pneumatic plug to air dry. Make sure that it is completely dry before storing it.

Carefully check the cleaned and dry pneumatic plug for:

- air pockets, cuts and worn parts that may hide under the dirt. Mark the damage or defect with chalk. Consult the manufacturer or an authorized representative about the seriousness of the damage and further use of pneumatic plugs.
- damage to the connecting coupling. If damage prevents connecting the connector of the connecting hose to the connecting coupling on the pneumatic plug, replace the coupling.



The use of a high-pressure cleaner is not allowed.  
Do not dry pneumatic plugs in a drier or with heating devices.



## 12.2. CLEANING OF INFLATION HOSES

Use a stiff-bristled brush to remove adhering dirt from the surface of inflation hoses. Move the brush in different directions. Once all adhering dirt is removed, soak the stains on the hoses with a mild solution of dishwashing detergent and warm water, and remove remaining dirt from the surface with a stiff-bristled brush. Do not use petrol, thinner, alcohol or aggressive cleaning agents. Rinse the inflation hoses with clean cold water.

Check the inlet of the connector and the coupling. If they are clogged with dirt, remove it with a thin wire. Always pull the dirt out of the connector or coupling, do not push it into the hose. Wipe the inflation hoses with a dry cloth.

Carefully check the cleaned and dry inflation hoses for:

- air pockets, cuts and worn parts that may hide under the dirt. Consult the manufacturer or an authorized representative on the seriousness of the damage and further use of inflation hoses.
- damage to the couplings. If damage prevents connecting the connector of the connecting hose to the connecting coupling, replace the hose.



The use of a high-pressure cleaner is not allowed.  
Do not dry inflation hoses in a drier or with heating devices.

## 12.3. CLEANING OF CONTROLLERS

After use, wipe dirt from the controller with a cloth. Use a mild solution of dishwashing detergent and warm water for cleaning.

Check the inlet of the connector and the coupling. If they are clogged with dirt, remove it with a thin wire. Always pull the dirt out of the connector or coupling, do not push it into the hose. Wipe the controller with a dry cloth.

Carefully check the cleaned and dry controller for:

- worn parts that may hide under the dirt. Consult the manufacturer or an authorized representative on the seriousness of the damage and further use of the controller.
- damage to the coupling and the connector. If damage prevents connecting the connector of the connecting hose to the connecting coupling, replace the hose.



The use of a high-pressure cleaner is not allowed.  
Immersion of the controller in water is not allowed.  
Do not dry the controller in a drier or with heating devices.

## 12.4. REPLACING THE COUPLING AND EYEBOLTS ON THE PNEUMATIC PLUG

It is allowed to replace the coupling and eyebolts on the plug.

To replace the coupling, prepare a spare coupling, a fork spanner of appropriate size, Teflon seal tape, soapy water and a brush for soapy water application. To replace the eyebolts, prepare spare eyebolts and a fork spanner of appropriate size.

You can replace plug components yourself by following the steps below; the procedure applies to both the eyebolts and the couplings.

## REPLACEMENT OF CONNECTING COUPLING

Unscrew the coupling on the pneumatic plug with a fork spanner, as shown in the figure.



Wrap Teflon seal tape around the thread of the connection coupling at least five times. Make sure to wind the tape clockwise, as shown in the figure. Improper sealing with Teflon seal tape may result in leakage of the pneumatic plug.

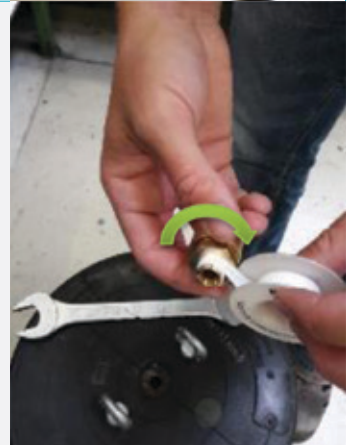

Tighten the new connecting coupling as shown in the figure.



Inflate the pneumatic plug to 1.2 times the minimum nominal diameter of the pneumatic plug. Check the tightness between the connecting coupling and the plug with soapy water. If you notice a leak, unscrew the connecting coupling and reseal with Teflon seal tape.

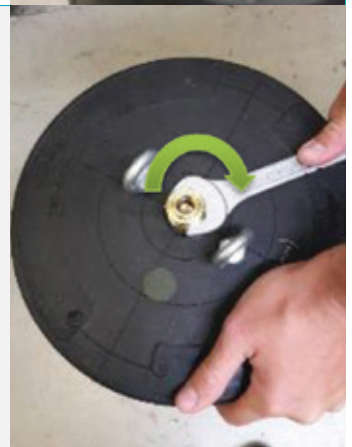

Replacement or repair of other plug components is not allowed.

## 13.0. MAINTENANCE OF PNEUMATIC PLUG SYSTEM

Preventive maintenance with testing includes inspection of pneumatic plugs and the accessories, carrying out tests and the replacement of damaged components to ensure user safety. Testing consists of visual, functional and periodic testing.



We recommend that you carry out a visual and functional test of the pneumatic plug system after every use.

Visual and functional tests may be carried out by a person qualified to work with pneumatic plugs.

Pressure tests may only be carried out after prior visual inspection of the entire system has proven the system is faultless. Always use protective equipment when testing – at least a safety helmet, safety glasses, gloves, footwear and hearing protection.



If the plug was in contact with a hazardous substance or biohazard, pay special attention to the personal protection of the cleaning service provider. Use additional protective equipment, e.g. protective clothing, respiratory protection, etc.

We recommend that testing is carried out outdoors, with adequate safety distances between persons present and the test object, as well as between buildings in the vicinity, or in a dedicated indoor space with appropriately reinforced construction, dedicated protection, pressure relief and manipulation of the test area.



Pressure tests may only be carried out in pipes of appropriate dimensions and strengths complying with the EN 13445-3 standard.

As the manufacturer, we recommend that you carry out periodic tests in the 5<sup>th</sup>, 10<sup>th</sup> and 13<sup>th</sup> year after the pneumatic plug has been manufactured. Periodic tests include visual, functional and periodic tests of the entire system. They are carried out according to the procedure specified by the manufacturer. They may only be carried out by the manufacturer or by a person authorized by the manufacturer. The applicable local regulations must also be observed. The recommended tests are summarized in the table below.

Table 7:

INSPECTION	INSPECTION INTERVAL	OPERATOR
Inspection of the plug	<ul style="list-style-type: none"> <li>• Before use</li> <li>• After every use</li> <li>• Annually</li> </ul>	A person qualified for work with pneumatic plugs.
Inspection of the controller	<ul style="list-style-type: none"> <li>• After every use</li> <li>• Annually</li> </ul>	A person qualified for work with pneumatic plugs.
Inspection of connecting hoses	<ul style="list-style-type: none"> <li>• After every use</li> <li>• Annually</li> </ul>	A person qualified for work with pneumatic plugs.
Periodic testing of the pneumatic plug	In the 5 <sup>th</sup> , 8 <sup>th</sup> , 10 <sup>th</sup> , 11 <sup>th</sup> , 12 <sup>th</sup> , 13 <sup>th</sup> and 14 <sup>th</sup> year after the manufacture.	The manufacturer or a person authorized by the manufacturer.

## 13.1. TEST PROCEDURES



Testing with plug inflation should be carried out outdoors or in a dedicated space. When inflating the plug, use the specified personal protective equipment. Observe the maximum permitted plug diameter and pressure in the plug.

### 13.1.1. INSPECTION OF PLUG

#### **Visual inspection of deflated plug:**

Visually check the deflated plug for damage. Pay special attention to any unusual bulges, punctures, cuts or any other mechanical damage. Check the entire surface of the pneumatic plug, including the connection and eyebolts, if any. Visually check for tightness of the pneumatic plug and the connection. With small-sized plugs, squeeze the plug body by hand and visually check for cracks.

#### **Visual inspection of inflated plug:**

Visually check the inflated plug. Using inflation hoses and the controller, inflate a cylindrical pneumatic plug to a maximum of 1.2 times the minimum nominal diameter of the selected plug and check it for damage. Inflate the glued plugs to the maximum nominal diameter, ensuring that the pressure in the pneumatic plug does not exceed 0.1 bar. Pay special attention to any unusual bulges, punctures, cuts or any other mechanical damage. If necessary, apply soapy water over the entire surface of the pneumatic plug, including the connection and eyebolts, if any. Visually check the pneumatic plug and connector for tightness. With small-sized plugs, squeeze the plug body by hand and visually check for cracks.

### 13.1.2. INSPECTION OF CONTROLLER

#### **Visual inspection:**

Visually check the controller for damage. Pay special attention to the inlet safety coupling, outlet connection, pressure gauge and the markings on the pressure gauge, its housing and protective cover.

#### **Controller leak test:**

Connect the controller to the air source and fill it to 0.5 times the working pressure. Using a brush, apply soapy water over the entire controller housing, the valve and all connections. Air bubbles escaping from the soapy water-coated surface indicate a leak. After the soapy water test, wipe the controller with a dry cloth. The controller may be fully immersed in water and checked for leaks. Leak is indicated by the visible escape of air bubbles at the leakage site. Remove the controller from water and dry it. Visually check all controller components for leaks.

#### **Functional test:**



A functional controller test has of two parts: functional test of pressure gauge and functional test of safety valve.



A functional test of the controller may only be carried out after the controller has passed the visual inspection and leak test.

To perform a functional test of the pressure gauge, use a reference pressure gauge with the same measuring range and one class higher accuracy than that of the pressure gauge under test. Connect in series the reference pressure gauge and the tested pressure gauge to the pressure adjustable air source and gradually increase the pressure and measure the deviation of the pressure gauge tested at three points (i, ii, iii), where:

- point i: at approximately 1/3 of the nominal value of the controller,
- point ii: at approximately 2/3 of the nominal value of the controller,
- point iii: at the nominal value of the controller.

If the deviation at any point exceeds 5% of the nominal value of the controller, the tested pressure gauge is not suitable for further use and should be removed from service.

To perform a functional test of the safety valve on the controller, connect the controller to an adjustable pressure air source. Gradually increase the pressure in the controller up to a maximum of 1.3 times the working pressure or until the safety valve is activated (safety valve leak). The safety valve is faultless if it activates within the range  $(1.1 \pm 0.05)$  times the working pressure of the controller



The activated safety valve makes a strong characteristic sound.

### 13.1.3. INSPECTION OF INFLATION HOSES

#### **Visual inspection:**

Visually check inflation hoses for damage. Pay special attention to the connecting coupling, outlet connector and the hose. If you notice tears, punctures, hardened areas, areas in contact with acids or any other damage, the hose is not suitable for use.

#### **Inflation hose leak test:**

To test the tightness of inflation hoses, connect the inflation hoses to an air source and fill them up to the 0.5 times the working pressure. Use a stop coupling to block the hose. Fully immerse the inflation hose in water and check for leaks. The escaping air bubbles indicate the location of the hose leak. Remove the inflation hose from water and dry it. If necessary, apply soapy water over the entire surface of the inflation hoses and check for leaks. The escaping air bubbles indicate the location of the hose leak. After the soapy water test, wipe the inflation hoses with a dry cloth.

#### **Functional test:**



A functional test of inflation hoses may only be carried out after the inflation hoses have passed the visual inspection and leak test.

To perform a functional test of inflation hoses, connect the connecting hose to the controller and gradually adjust the pressure to the maximum pressure value of the pressure gauge. Close the valve at the air source and observe if the pressure on the pressure gauge of the controller drops. The inflation hose is faultless if the pressure drop after 30 seconds does not exceed 5% of the maximum pressure value on the pressure gauge.

### 13.1.4. PERIODIC TESTING OF PNEUMATIC PLUGS



A periodic test of the cylindrical pneumatic plug may only be carried out after the cylindrical pneumatic plug and accessories have passed the inspection.



Carry out periodic tests in suitable test pipes that are dimensioned to the maximum diameter of the pneumatic plug.  
Follow all safety instructions and warnings when carrying out the test!

The following equipment is required to carry out a periodic test of plugs:

- test pipe,
- air source,
- pneumatic plug system,

- test tub with water,
- soapy water and a brush for its application.

To perform a periodic test of the pneumatic plug, insert the plug into the pipe and inflate it to 1.0 times the working pressure. After 30 seconds, recheck the pressure in the plug (stretching of the pneumatic plug) and adjust it to 1.0 times the working pressure. Leave the plug inflated for 30 seconds and then check the pressure in the plug. If there is no pressure drop in the plug, the plug is suitable for further testing.

Inflate the pneumatic plug to 1.3 times the working pressure. After 30 seconds, recheck the pressure in the plug (stretching of the pneumatic plug) and adjust it to a test pressure of 1.3 times the working pressure. Leave the plug inflated for 30 seconds and then check the pressure in the plug. If there is no pressure drop in the plug, the plug is suitable for use.

After the test, release the air from the pneumatic plug and remove it from the pipe. Visually check the plug in both the deflated and inflated state.





Damaged products or accessories are hazardous to use; they should be removed from service and replaced with flawless products and accessories.

### 13.2. CRITERIA INTERPRETATION

The table below explains the criteria of checking the products, which can help you make decisions in terms of testing. The table includes images that are for illustration purposes only and serve to help you identify the fault. The products that have any of the listed defects are not suitable for further use.

Table 8:

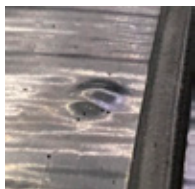
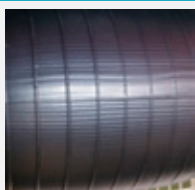
CRITERION	INTERPRETATION	SYMBOLIC IMAGE
Leak	Any air leakage from the plug is considered a leak. A leak can occur in a punctured or damaged area of the plug body or at the bottom of the pneumatic plug. Leak can occur on metal components (coupling, flange, bypass tube).	
Visible cuts	Traces of usage and cuts on pneumatic plugs due to moving pneumatic plugs along the pipe.	
Cracks and indentations due to hard parts	Cuts, cracks or indentations on the surface of the plug where the plug contacts the pipe.	
Spreading of load-bearing cord	Load-bearing cord spreading can only occur with reinforced cylindrical pneumatic plugs. When inflating pneumatic plugs outside the pipe (up to a maximum diameter 20% larger than the minimum nominal diameter of the selected plug), cord threads of the plug's rubber body may spread. The difference in spreading must not exceed 20%.	



CRITERION	INTERPRETATION	SYMBOLIC IMAGE
Reshaping of cover/bottom of a cylindrical pneumatic plug	During inflation of a cylindrical pneumatic plug, its cover or bottom may become elliptical. The difference in diameter must not exceed 5%.	
Poor rubber to rubber bonding	Inflating the pneumatic plug can cause poor bonding between rubber layers, resulting in separation of the rubber body edge from the cover or bottom.	
Poor rubber to metal bonding	Inflating the pneumatic plug can cause poor bonding between the rubber and built-in metal components, resulting in rubber separation from the metal, peeling, splitting, delaminating. In the case of bypass plugs, it may result in poor bonding between the bypass tube and its metal fitting.	
Overloading the pneumatic plug	Overloading the pneumatic plug occurs if the plug is incorrectly inserted into the pipe; it shows as a plug deformation (the plug inflates beyond its nominal diameter).	
Effects of sunlight	Cracks can form over the entire surface of pneumatic plugs exposed to direct sunlight – either on the rubber body or its bottom.	
Chemical effects	Cracks and eroded areas can form over the entire surface of pneumatic plugs exposed to aggressive substances.	
Improperly stored products	Wrinkles may form on the surface of pneumatic plugs if not stored in accordance with the instructions for use, or depressurized for an extended period of time. The load-bearing fabric in the wrinkles can deform and plugs no longer assume their proper shape when inflated, which is why they are not suitable for use.	



If you have any doubts about further safe use of pneumatic plugs and accessories, please consult your product dealer, an authorized repair workshop or the manufacturer.





Trelleborg is a leading global provider of solutions and engineered products made from polymer materials that provide sealing, damping and protection at critical points in demanding environments. Its innovative solutions sustainably improve business performance of customers.



[www.trelleborgslovenija.com](http://www.trelleborgslovenija.com)  
[www.trelleborg.com](http://www.trelleborg.com)



Trelleborg Slovenija d.o.o.  
Škofjeloška cesta 6, 4000 Kranj, Slovenia

T: +386 (0)4 206 6388  
E: [tis.kra.info.eko@trelleborg.com](mailto:tis.kra.info.eko@trelleborg.com)  
F: +386 (0)4 206 6390

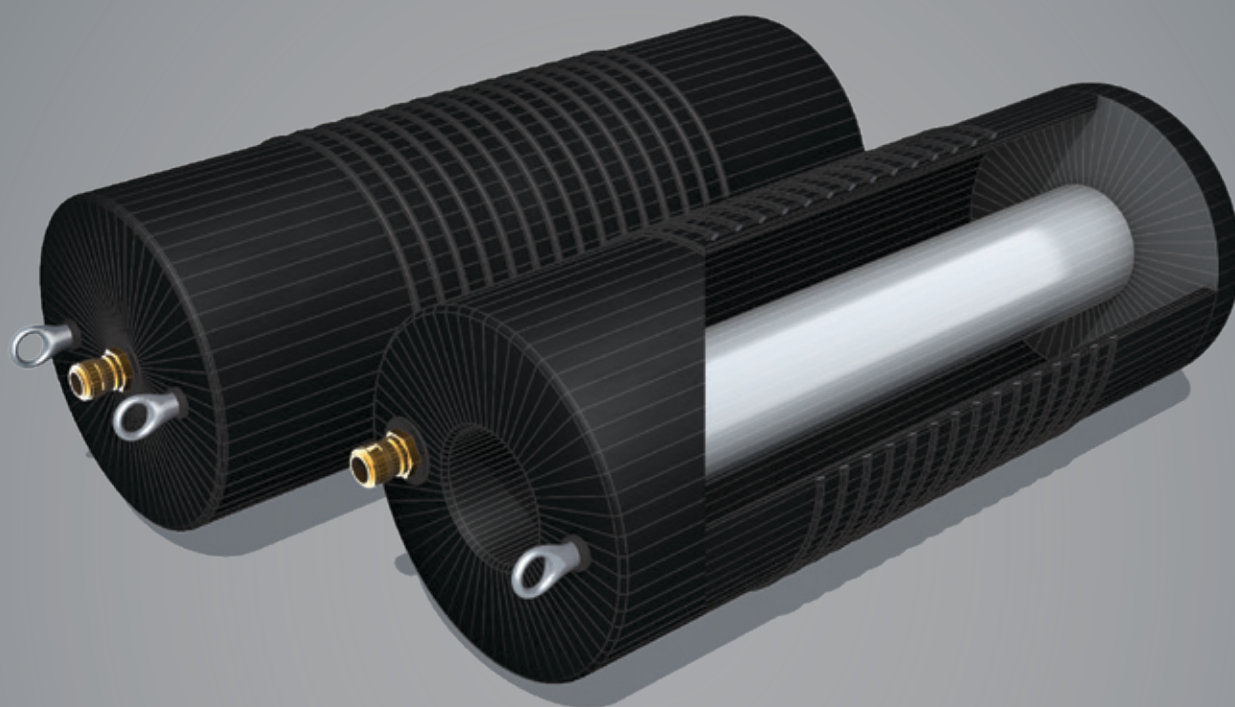

# Attachments to the user manual

## LIST OF ATTACHMENTS

- ATTACHMENT 1:** WARRANTY STATEMENT
- ATTACHMENT 2:** QUICK START GUIDE FOR USE OF PLUGS
- ATTACHMENT 3:** MEDIA RESISTANCE TABLE
- ATTACHMENT 4:** TECHNICAL CHARACTERISTICS OF THE PRODUCTS
- ATTACHMENT 5:** PILLOW AND CONICAL PLUGS, HOUSE CONNECTION TEST KIT, AIR LEAK TEST, WATER LEAK TEST
- ATTACHMENT 6:** TABLE OF CONTROLLERS, TABLE OF INFLATION HOSES

# ATTACHMENT 1: WARRANTY STATEMENT

## 1. GENERAL TERMS AND CONDITIONS

- 1.1. These warranty terms and conditions apply to environmental protection and rescue products, manufactured by Trelleborg Slovenija, d.o.o. (hereinafter Products). If any provision of this warranty would be contrary to any cogent legal provisions in any particular jurisdiction, such provision shall apply to a maximum extent as provided for by such cogent legal provisions.
- 1.2. The Products which may be sold by Trelleborg Slovenija, PG EKO, but are not manufactured by it are not covered by this warranty and are sold exclusively with warranties, if any, by their original manufacturer.

## 2. MANAGEMENT OF PRODUCTS

- 2.1. In order to claim a remedy pursuant to this warranty, purchaser must conform to the instructions for management of the Products, available at [www.trelleborgslovenija.com/eko-garancijski-pogoji](http://www.trelleborgslovenija.com/eko-garancijski-pogoji).

## 3. WARRANTY

- 3.1. Trelleborg Slovenija, d.o.o. warrants to the purchaser that for a period of twelve (12) months as of delivery of the Products, such Products shall be free from defects in material and workmanship, subject to normal use and management of the Products, including, among others, proper storage. For high-pressure lifting bags, the warranty period amounts to thirty-six (36) months as of delivery.
- 3.2. This warranty shall be in lieu of any other warranties, express or implied, including, but not limited to, any warranty of merchantability or fitness for a particular purpose.

## 4. EXCLUSION OF WARRANTY

- 4.1. Warranty shall be excluded in cases where the Products have not been used for the ordinary purpose or have been exposed to abnormal conditions such as, but not limited to misuse, mishandling (such as, but not limited to, cuts, tears, vandalism, fire, wilful destruction, improper installation and/or improper maintenance, misapplication), use of unauthorized components or attachments or if adjustments or repairs have been performed by anyone other than Trelleborg Slovenija, d.o.o. or its authorized agents.
- 4.2. Warranty shall also be excluded and Trelleborg Slovenija, d.o.o. shall not be held liable in case of force majeure, such as, but not limited to:
  - war or threat of war, sabotage, insurrection, riots or requisition;
  - all legal and other restrictions, regulations, by-laws, prohibitions or any other measures by public authorities;
  - import and export regulations or embargo;
  - strikes, lock-outs or other industrial measures or trade disputes (if including Manufacturer's employees or third party);
  - disruptions in supply of raw materials, work force, fuel, parts or machinery;
  - power blackout or break of machinery.
- 4.3. Trelleborg Slovenija, d.o.o. shall not be held liable for any deficiencies in Products manufactured according to drawings, designs, project drafts and/or specifications provided by the purchaser.
- 4.4. Normal wear and tear are not covered by this warranty.

## 5. FILING A COMPLAINT

- 5.1. Purchaser is obliged to take delivery of the Products and perform a careful inspection of the Product upon delivery.
- 5.2. Any complaints by the purchaser with reference to the Products shall be made in writing within the earlier of (I) eight (8) days as of the discovery of the defect, or (II) twelve (12) months as of the date of delivery of the Products or thirty-six (36) months as of delivery of high-pressure lifting bags. A defect is deemed to have been detected when it could reasonably have been expected to have been detected by the purchaser during the usual check.
- 5.3. The complaint must contain at least the following information:
  - part number,
  - serial number of the Product,
  - detailed description of defect.The complaint must be accompanied by sufficient evidence, such as photographs.  
At the request of Trelleborg Slovenija, d.o.o., the Product should be made available for inspection.
- 5.4. To obtain performance under this warranty, any Products suspected of having a manufacturing defect in materials or workmanship shall be returned, freight prepaid, for inspection to Trelleborg Slovenija, d.o.o., PG EKO, Škofjeloška c. 6, 4000 Kranj, Slovenia.

## 6. COMPLAINT PROCEDURE

- 6.1. Trelleborg Slovenija, d.o.o. shall decide on validity of the complaint within forty-five (45) days of receipt of the complete documentation and the Product pursuant to Article 5.
- 6.2. Providing Trelleborg Slovenija, d.o.o. acknowledges the complaint as valid, it shall, at its discretion, either:
  - repair the Product,
  - replace those components of the Product which are defective,
  - replace the Product, if repair is not possible,
  - reimburse the consideration for the Product and/or its defective components.
- 6.3. Whenever Trelleborg Slovenija, d.o.o. repairs or replaces the Product at its expense or reimburses the purchase price, it shall reimburse the purchaser, with a credit note, the same surface freight amount the purchaser had when returned the Product to Trelleborg Slovenija, d.o.o.
- 6.4. Complaint procedure pursuant to Article 6 shall constitute the sole and exclusive manner of resolving the matter if a complaint is filed. Trelleborg Slovenija, d.o.o. shall not be liable for any incidental, consequential and/or non-pecuniary damages or damage having a comparable effect. Any liability for damages of Trelleborg Slovenija d.o.o. arising from a written contract or order or similar document creating a contractual relationship, shall be limited by the amount of the invoiced price for the Products supplied. All limitations pursuant to this Warranty Statement are also deemed to be agreed for the benefit of each individual company within the Trelleborg Slovenija, d.o.o. Group.

## 7. FINAL PROVISIONS

- 7.1. No statement or action by Trelleborg Slovenija, d.o.o. – either express or implied – other than set forth herein, shall constitute a warranty.
- 7.2. Any applicability of general terms and conditions used by the purchaser, wherever stated or accessible, is hereby explicitly excluded, notwithstanding any provisions of such general terms and conditions of the purchaser to the contrary.
- 7.3. This Warranty Statement shall be governed by the law of the Republic of Slovenia to the exclusion of the provisions of the Private International Law and Procedure Act (or any other law governing this area) and/or a connecting factor that would refer to the choice of another law.

Kranj, 1 May 2019  
Trelleborg Slovenija, d.o.o  
PG EKO

# ATTACHMENT 2: QUICK START GUIDE FOR USE OF PLUGS

Attachment 2 provides quick instructions on how to use pneumatic plugs.

## 1.1. QUICK START GUIDE FOR USE OF PNEUMATIC PLUGS

Step 1		<b>PROCEDURE</b> Determine the back pressure and choose the right SAVA pneumatic plug.	<b>WARNING</b> To choose the right SAVA pneumatic plug, refer to technical data and back pressure tables.
Step 7		<b>PROCEDURE</b> Inflate SAVA pneumatic plug up to the nominal pressure.	<b>WARNING</b> Staying in the area of a pressurized SAVA pneumatic plug is forbidden. Do not exceed the nominal working pressure in SAVA pneumatic plug.
Step 2		<b>PROCEDURE</b> Check and prepare at the site of use: air source, pneumatic plug, controller and air hoses.	<b>WARNING</b> Before use thoroughly inspect SAVA pneumatic plug and accessories. Damaged product or damaged accessories are dangerous to use; they should be removed from service and replaced.
Step 8		<b>PROCEDURE</b> Check the pressure in SAVA pneumatic plug throughout the procedure.	<b>WARNING</b> If the pressure in SAVA pneumatic plug changes, adjust it to the prescribed working pressure.
Step 3		<b>PROCEDURE</b> Clean the pipe into which SAVA pneumatic plug will be inserted.	<b>WARNING</b> Even small sharp particles, as a result of uncleaned pipes, can permanently damage SAVA pneumatic plug.
Step 9		<b>PROCEDURE</b> After work is finished, release the back pressure.	<b>WARNING</b> Emptying the plug, exposed to the back pressure, can result in uncontrolled movement of the plug in the direction of the back pressure.
Step 4		<b>PROCEDURE</b> Connect the air source, controller and SAVA pneumatic plug.	<b>WARNING</b> Use a controller of appropriate pressure class for inflating SAVA pneumatic plug. The safety valve on the controller must fully correspond to the working pressure of SAVA pneumatic plug.
Step 10		<b>PROCEDURE</b> Deflate SAVA pneumatic plug.	<b>WARNING</b> Before emptying the plug, repeatedly check for any remaining back pressure.
Step 5		<b>PROCEDURE</b> Insert SAVA pneumatic plug into the pipe.	<b>WARNING</b> Place SAVA pneumatic plug horizontally in the middle of the pipe cross-section.
Step 11		<b>PROCEDURE</b> After use, clean the deflated SAVA pneumatic plug and the accessories; store them in accordance with the instructions.	<b>WARNING</b> Follow the instructions for cleaning and storage of SAVA pneumatic plugs.
Step 6		<b>PROCEDURE</b> Set a safety support for SAVA pneumatic plug.	<b>WARNING</b> If the safety support is not used and the back pressure is exceeded there is a risk of injury to persons.
Step 12		<b>PROCEDURE</b> Thoroughly check SAVA pneumatic plug and the accessories.	<b>WARNING</b> Remove damaged products or accessories from service and replace them.





Failure to follow the instructions can result in various injuries, which is why be sure that in addition to the quick start guide you also read the long version of instructions for use available at:



[www.trelleborgslovenija.com/en/products-and-solutions/  
environmental-protection-and-rescue-products/downloads/manuals](http://www.trelleborgslovenija.com/en/products-and-solutions/environmental-protection-and-rescue-products/downloads/manuals)



### PERSONAL PROTECTIVE EQUIPMENT

When working with SAVA pneumatic plugs, use the following personal protective equipment: protective clothing, safety helmet, safety goggles, safety gloves, safety footwear and hearing protection.



### WARNINGS:

The temperature range of use is from  $-20$  to  $+80$  °C. Using the product at temperatures below  $-20$  °C but not below  $-40$  °C is limited to a maximum of 1 hour, at temperatures above  $+80$  °C to 30 minutes; however, the temperature must not exceed  $100$  °C.



The standard design of SAVA pneumatic plugs is **NOT** suitable for use in potentially explosive atmospheres.



The use of open flames and smoking is forbidden when working with SAVA pneumatic plugs.

### CHOOSING THE RIGHT SAVA PNEUMATIC PLUG

When choosing the right SAVA pneumatic plug for a specific application, please refer to technical data tables and the labels on the products.



SAVA pneumatic plugs are not resistant to all types of chemicals. When choosing between NrBr, CR and NBR plug design, please refer to the Rubber Resistance Table or consult the manufacturer.

## ATTACHMENT 3: MEDIA RESISTANCE TABLE

Attachment 3 contains the Media Resistance Table.

### 1.1. MEDIA RESISTANCE TABLE



The Media Resistance Table has been produced in accordance with the ISO/TR 7620 standard.

The table below gives an extract of the most commonly used media in connection with pneumatic plugs. If the media you use is not listed in the table, please check the ISO/TR 7620 standard or consult the manufacturer about the use of a pneumatic plug.

In the table, the effect of the medium on the product is marked as shown below; it serves for orientation in selection of a pneumatic plug depending on the rubber compound from which it is made.

1 NEGLIGIBLE	2 LOW	3 MEDIUM	4 HIGH
--------------	-------	----------	--------

Figure 1: Effect of the media on rubber compound

Table 1:

MEDIA	CONCENTRATION [%]	TEMPERATURE [°C]	RUBBER COMPOUND		
			NR/BR	CR	NBR
Acetone		23	1	2	4
Acetylene			1	2	1
Ammonium hydroxide	10	23	1	1	1
	Conc.	23	1	1	2
Aniline		23	2	3	4
		100	4	4	4
Benzene		23	4	4	4
Boric acid	10	100	1	1	1
Brake fluid (vegetable)		50	1	1	4
Butanol		50	1	1	1
		100	4	3	1
Butyric acid				2	4
Calcium hydroxide		100	1	1	2
Calcium hypochlorite	15		4	2	3
Hydrochloric acid	20	23		4	4
Ethanol		50	1	1	1
Ether		23	4	4	2

MEDIA	CONCENTRATION [%]	TEMPERATURE [°C]	RUBBER COMPOUND		
			NR/BR	CR	NBR
Formaldehyde	40	23	1	1	1
		70			4
Glycerol		100	1	1	1
Hexanol		23	1	2	2
Hydrogen peroxide	30	23	1	1	1
	90		4	4	4
Kerosene		70	4	3	1
Methanol		50	1	1	1
Methyl chloride			4	4	4
Milk		23	1	1	1
Mineral oils No. 1		100	4	1	1
Mineral oils No. 2		100	4	2	1
Mineral oils No. 3		100	4	4	1
Petroleum		23	4	4	1
Natural gas			3	1	1
Dilute nitric acid	10	50	2	3	2
Ozone (conc. 50 pphm)		40	4	2	4
Phenol		100	4	4	4
Phosphoric acid	60	50	2	2	3
Propanol		50	1	1	2
Sodium hydroxide	10	100	1	1	1
	25	100	1	1	4
Sodium hypochlorite	10	50	2	3	3
Sulphur hexafluoride				1	1
Sulphur acid (VI)	10	100	1	1	3
	20	23	1	1	3
	25	100	1	1	4
	50	100	1	1	4
	60	100	3	4	4
	75	100	4	4	4
			23	4	4
Toluene		23	4	4	4

# ATTACHMENT 4 : TECHNICAL CHARACTERISTICS OF PRODUCTS

Attachment 4 presents different pneumatic plug systems.

## 1.1. PLUGY Z AND PLUGSY S

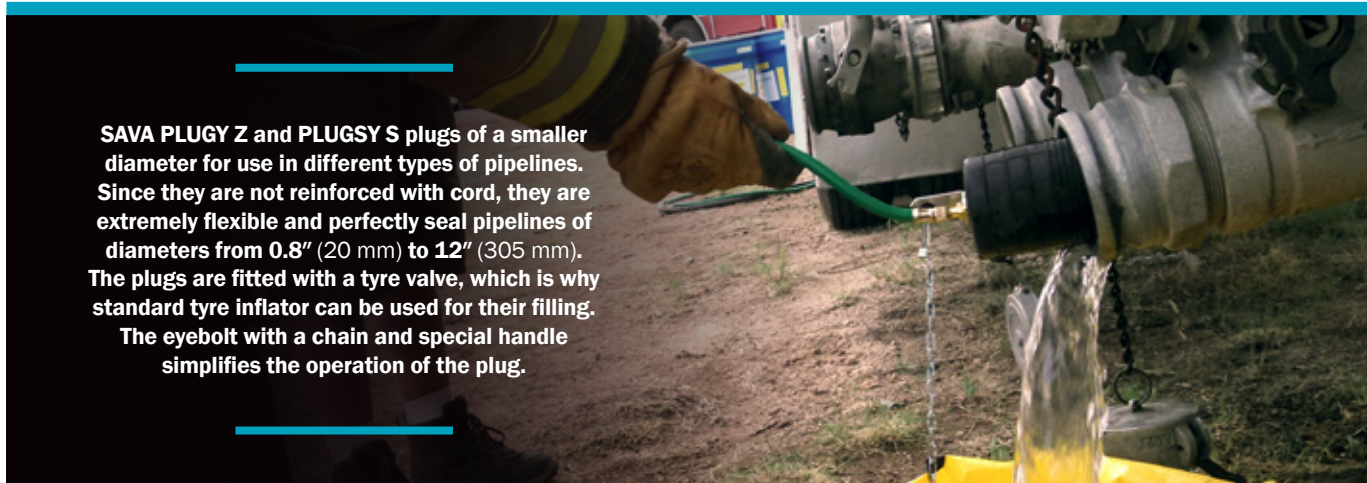

**SAVA PLUGY Z and PLUGSY S** plugs of a smaller diameter for use in different types of pipelines. Since they are not reinforced with cord, they are extremely flexible and perfectly seal pipelines of diameters from 0.8" (20 mm) to 12" (305 mm). The plugs are fitted with a tyre valve, which is why standard tyre inflator can be used for their filling. The eyebolt with a chain and special handle simplifies the operation of the plug.

Extremely short for easier insertion	Usage ranges from 0.8" (20 mm) to 12" (305 mm)	Oil-resistant material also available	Ideal for plumbing works
--------------------------------------	--	---------------------------------------	--------------------------

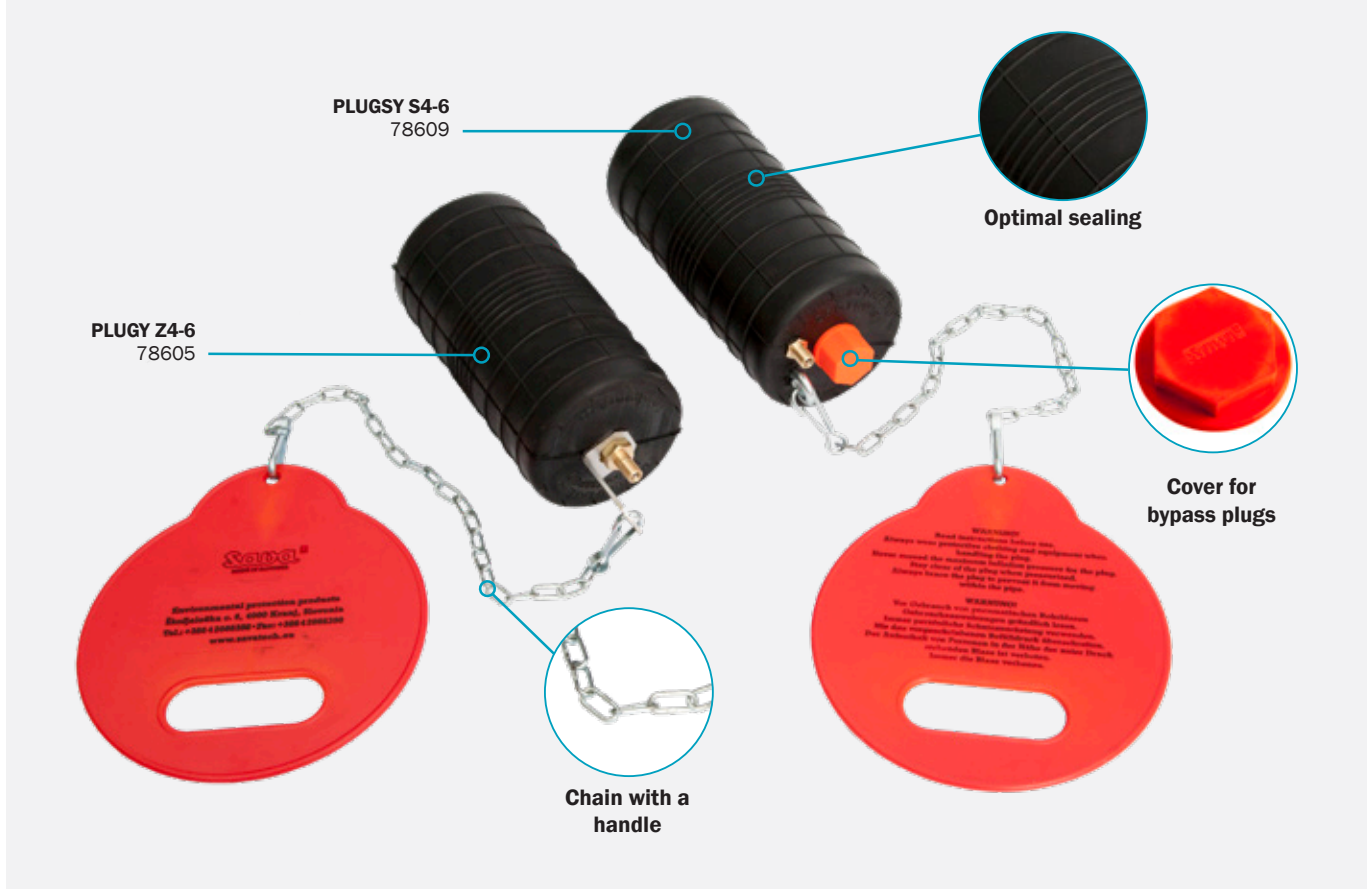

Scan the QR code to access technical data:



**PLUGY 2.5 BAR**

CODE	TYPE	USAGE RANGE		DEFLATED PLUG		PRESCRIBED INFLATION PRESSURE [bar]	PRODUCT WEIGHT [kg]
		MIN. DIAMETER [mm]	MAX. DIAMETER [mm]	DIAMETER [mm]	RUBBER BODY LENGTH [mm]		
508123	Z 1	20	33	19	65	2.5	0.01
60022	Z 1 1/2	33	40	32	70	2.5	0.09
78582	Z 2	46	52	45	72	2.5	0.11
78603	Z 2-3	46	77	45	80	2.5	0.12
76767	Z 3	71	77	70	85	2.5	0.23
78604	Z 3-4	71	102	70	100	2.5	0.25
76769	Z 4	86	102	85	145	2.5	0.43
78605	Z 4-6	86	153	85	165	2.5	0.47
76771	Z 6	143	153	142	190	2.5	1.23
78606	Z 6-8	143	204	142	220	2.5	1.32
60616	Z 8	175	204	174	220	2.5	2.1
60618	Z 10	219	254	218	250	2.5	3.4
60619	Z 12	275	305	274	290	2.5	5.1

**PLUGSY 2.5 BAR**

CODE	TYPE	USAGE RANGE		DEFLATED PLUG		PRESCRIBED INFLATION PRESSURE [bar]	PRODUCT WEIGHT [kg]
		MIN. DIAMETER [mm]	MAX. DIAMETER [mm]	DIAMETER [mm]	RUBBER BODY LENGTH [mm]		
78607	S 2	46	52	45	80	2.5	0.2
76768	S 3	71	77	70	85	2.5	0.3
78614	S 3-4	71	102	70	100	2.5	0.4
76770	S 4	86	102	85	145	2.5	0.6
78609	S 4-6	86	153	85	165	2.5	0.6
76772	S 6	143	153	142	190	2.5	1.9
78610	S 6-8	143	204	142	220	2.5	2.0
60621	S 8	175	204	174	240	2.5	3.4
60622	S 10	219	254	218	300	2.5	5.3
60623	S 12	275	305	274	350	2.5	9.3

**MAX. BACK PRESSURE [BAR]**

TYPE/SIZE	PIPE DIAMETER [mm]								
	25	40	50	75	100	150	200	250	300
1"	2.2								
1 1/2"		2.2							
2"			1.8						
2"- 3"			2	1.5					
3"				1.5					
3"- 4"				1.6	1.2				
4"					1.9				
4"- 6"					1.9	1.6			
6"						2.2			
6"- 8"						2.2	1.4		
8"							1.3		
10"								1.5	
12"									1.8

## 1.2. LONG PLUGS

The design of multi-size SAVA PLUGY DC long plugs allows simultaneous effective sealing of lateral connections and the main pipeline. SAVA PLUGY DC plugs are equipped with a 39.4" (100 cm) long inflation hose.

Special  
inflation procedure

Simultaneous sealing of the  
main and lateral pipes

Fitted with  
inflation hose

PLUGY DC 75-100 (3"-4")  
60074



Start of inflation



Scan the QR code to access technical data:



**PLUGY DC**

CODE	TYPE	USAGE RANGE		DEFLATED PLUG		PRESCRIBED INFLATION PRESSURE [bar]	PRODUCT WEIGHT [kg]	EYEBOLT	THREAD SIZE OF INFLATION VALVE
		MIN. DIAMETER [mm]	MAX. DIAMETER [mm]	DIAMETER [mm]	RUBBER BODY LENGTH [mm]				
60073	50-75	50	75	40	490	2.5	0.7	/	TR 15
60074	75-100	75	100	60	550	2.5	1.2	/	TR 15
60075	100-150	100	150	80	750	2.5	1.8	/	TR 15
60076	150	150	150	100	730	2.5	2.6	/	TR 15

**MAX. BACK PRESSURE [BAR]**

TYPE/SIZE	PIPE DIAMETER [mm]			
	50	75	100	150
50-75	2.2	2.0		
75-100		2.1	1.9	
100-150			2.0	1.8
150				1.9



### 1.3. PLUGS FOR SMALL INLET OPENINGS

Multi-size SAVA PLUGY G and PLUGSY GM plugs for sealing and testing pipelines and gas pipelines with restricted inlet openings. Their innovative design and flexibility simplify plug handling and insertion.

Special elliptical shape

For very small inlets

Highly flexible

Oil-resistant material also available

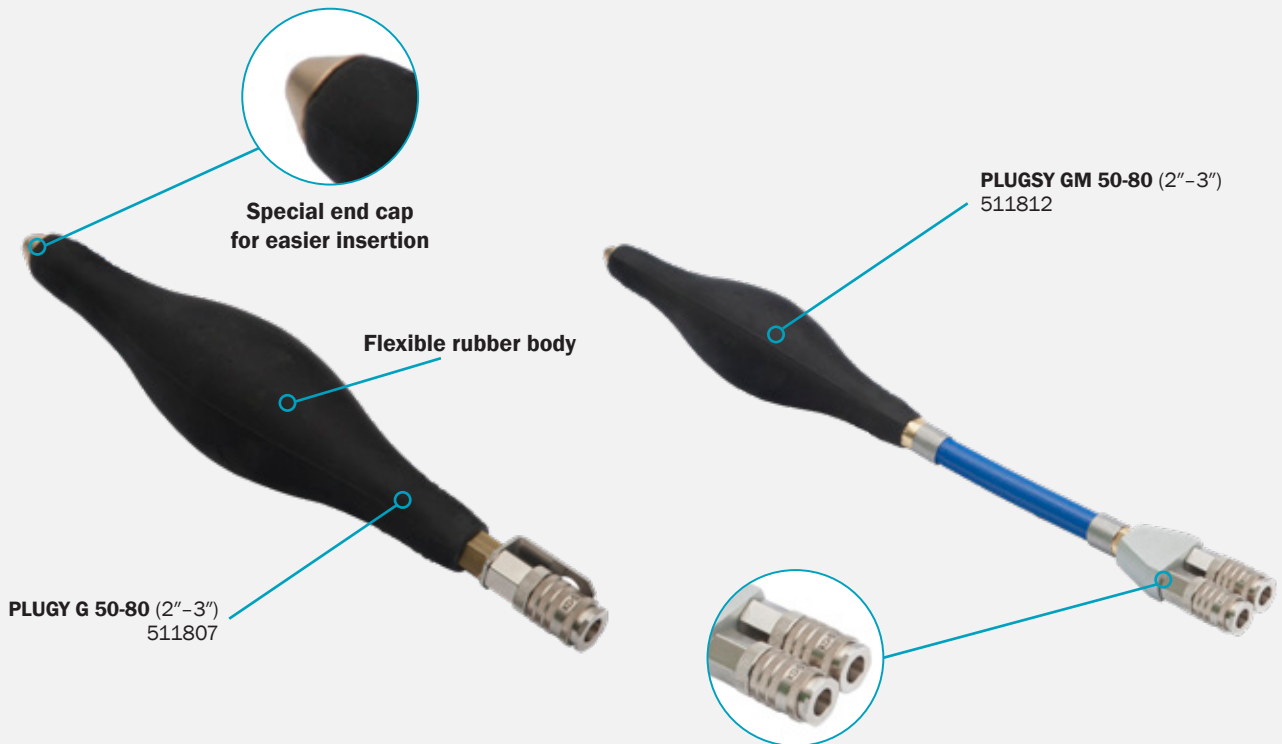

Scan the QR code to access technical data:



## PLUGY G

CODE	TYPE	USAGE RANGE		DEFLATED PLUG		PRESCRIBED INFLATION PRESSURE [bar]	MAX. BACK PRESSURE [bar]	INLET FOR INSERTION [mm]	PRODUCT WEIGHT [kg]	THREAD SIZE OF INFLATION VALVE
		MIN. DIAMETER [mm]	MAX. DIAMETER [mm]	DIAMETER [mm]	RUBBER BODY LENGTH [mm]					
511807	50-80	50	80	45	200	3	1.0	35.0	0.3	R1/4"
511808	80-130	80	130	76	285	2.5	1.0	40.0	0.4	R1/4"
511809	100-160	100	160	98	360	2	1.0	45.0	0.6	R3/8"
511810	150-210	150	210	140	455	2	1.0	50.0	0.8	R3/8"
511811	200-315	200	315	200	880	2	1.0	70	1.3	R3/8"
519240	315-500	315	500	315	950	1.5	0.8	90	1.5	R3/8"

## PLUGSY G

CODE	TYPE	USAGE RANGE		DEFLATED PLUG		PRESCRIBED INFLATION PRESSURE [bar]	MAX. BACK PRESSURE [bar]	INLET FOR INSERTION [mm]	PRODUCT WEIGHT [kg]	THREAD SIZE OF INFLATION VALVE
		MIN. DIAMETER [mm]	MAX. DIAMETER [mm]	DIAMETER [mm]	RUBBER BODY LENGTH [mm]					
511812	50-80	50	80	45	200	3	1.0	35.0	0.7	R1/4"
511813	80-130	80	130	76	285	2.5	1.0	40.0	0.8	R1/4"
511814	100-160	100	160	98	360	2	1.0	45.0	1.0	R3/8"
511815	150-210	150	210	140	455	2	1.0	50.0	1.2	R3/8"
511816	200-315	200	315	200	880	2	1.0	70	1.7	R3/8"
519421	315-500	315	500	315	950	1.5	0.8	90	1.9	R3/8"

## MAX. BACK PRESSURE [BAR]

TYPE/SIZE		PIPE DIAMETER [mm]										
		50	75	100	125	150	200	225	300	350	400	500
Plugy G	50-80	1.2	1.1									
	80-130			1.2	1.1							
	100-160			1.3	1.2	1.1						
	150-210					1.2	1.1					
	200-315						1.3	1.2	1.1			
	315-500									1.0	0.9	0.8
Plugsy G	50-80	1.2	1.1									
	80-130			1.2	1.1							
	100-160			1.3	1.2	1.1						
	150-210					1.2	1.1					
	200-315						1.3	1.2	1.1			
	315-500									1.0	0.9	0.8

## 1.4. LARGER PLUGS – PLUGY AND PLUGSY

Multi-size SAVA PLUGY and PLUGSY plugs, reinforced with aramid cord, allow a wide range of applications. Each plug can cover several different pipe diameters, ranging from 1.5" (40 mm) to 72" (1800 mm). Their sizes overlap; therefore, these plugs can meet specific application requirements. Since they are flexible and bendable, they can be installed around the bends of the pipe or inserted through the manholes.



**Aramid reinforcement**

**Flexible design**

**Suitable for leak test according to EN 1610**

**Oil-resistant material also available**

**PLUGY 350-600**  
(14"-24")  
60422



**PLUGSY 350-600**  
(14"-24")  
60440



**PLUGY 600-1200**  
(24"-48")  
523941



**PLUGSY 600-1200**  
(24"-48")  
523942



Scan the QR code to access technical data:



## PLUGY 2.5 BAR

CODE	TYPE	USAGE RANGE		DEFLATED PLUG		PRESCRIBED INFLATION PRESSURE [bar]	PRODUCT WEIGHT [kg]	EYEBOLT	INFLATION VALVE
		MIN. DIAMETER [mm]	MAX. DIAMETER [mm]	DIAMETER [mm]	RUBBER BODY LENGTH [mm]				
519423	40-70	40	70	35	160	2.5	0.3	NA	R 1/4"
519424	70-150	70	150	68	300	2.5	0.6	NA	R 1/4"
60417	100-200	100	200	92	500	2.5	1.1	M6	R 1/4"
526850	150-200	150	200	142	350	2.5	1.8	M8	R 1/4"
60418	150-300	150	300	142	540	2.5	1.9	M8	R 1/4"
60419	200-400	200	400	192	600	2.5	3.0	M8	R 1/4"
598515	200-500	200	500	192	600	2.5	4.5	M8	R 1/4"
60599	300-525	300	525	272	630	2.5	6.0	M8	R 1/4"
598519	300-600	300	600	272	630	2.5	7.5	M8	R 1/4"
60422	350-600	350	600	322	830	2.5	839.0	M10	R 1/4"
60606	375-750	375	750	342	1050	2.5	10.9	M10	R 1/4"
60453	500-800	500	800	472	1150	2.5	17.3	M10	R 1/4"
60425	500-1000	500	1000	472	1150	1.5	17.3	M10	R 1/4"
523941	600-1200	600	1200	574	1450	1.5	55.0	M10	2xR 3/8"
78959	750-1500	750	1500	600	2300	1	67.0	M10	2xR 3/8"
535881	800-1800	800	1800	600	3000	1	105.0	M10	2xR 1/2"

## PLUGSY 2.5 BAR

CODE	TYPE	USAGE RANGE		DEFLATED PLUG		PRESCRIBED INFLATION PRESSURE [bar]	PRODUCT WEIGHT [kg]	EYEBOLT	INFLATION VALVE	BYPASS DIAMETER
		MIN. DIAMETER [mm]	MAX. DIAMETER [mm]	DIAMETER [mm]	RUBBER BODY LENGTH [mm]					
526849	70-150	70	150	68	300	2.5	1.7	NA	R 1/4"	1/2"
60429	100-200	100	200	92	500	2.5	2.6	M6	R 1/4"	1"
526851	150-200	150	200	142	350	2.5	3.3	M8	R 1/4"	1"
60432	150-300	150	300	142	540	2.5	4.4	M8	R 1/4"	1"
60434	200-400	200	400	192	600	2.5	6.3	M8	R 1/4"	2"
60630	300-525	300	525	272	630	2.5	11.9	M8	R 1/4"	2"
60440	350-600	350	600	322	830	2.5	16.0	M10	R 1/4"	2"
60632	375-750	375	750	342	1050	2.5	64.0	M10	R 1/4"	2"
60454	500-800	500	800	472	1150	2.5	19.7	M10	R 1/4"	2"
60442	500-1000	500	1000	472	1150	2.5	31.3	M10	R 1/4"	2"
523942	600-1200	600	1200	574	1450	2.5	31.3	M10	2xR 3/8"	4"
78960	750-1500	750	1500	600	2300	2.5	60.0	M10	2xR 3/8"	4"
535882	800-1800	800	1800	600	3000	1.5	75.0	M10	2xR 1/2"	4"

## MAX. BACK PRESSURE [BAR]

TYPE/ SIZE	PIPE DIAMETER [mm]																				
	40	70	100	150	200	250	300	350	400	500	600	800	1000	1200	1300	1400	1500	1600	1700	1800	
40-70	2.0	1.2																			
70-150		2.2	1.7	1.3																	
100-200			2.2	1.7	1.3																
150-200				2.0	1.5																
150-300				2.2	2.0	1.4	1.2														
200-400					2.2	2.0	1.7	1.5	1.2												
200-500					2.3	2.2	2.1	1.7	1.5	0.7											
300-525							2.0	1.7	1.5	1.2											
300-600							2.2	2.0	1.7	1.2	0.4										
350-600								2.1	1.9	1.6	1.3										
375-750									2.0	1.7	1.4										
500-800										1.8	1.4	1.1									
500-1000										1.0	0.8	0.6	0.5								
600-1200											1.0	0.7	0.6	0.5							
750-1500												1.0	0.9	0.7	0.6	0.5	0.4				
800-1800													1.0	1.0	0.8	0.7	0.6	0.5	0.5	0.4	0.4

## 1.5. HIGH PERFORMANCE PLUGS – PLUGY HPF AND PLUGSY HPF

High performance SAVA PLUGY and PLUGSY HPF plugs are made from a high-quality rubber compound and additionally reinforced with aramid for reliability in more demanding conditions of use. These plugs are ideal for flow blockage and pipeline leak testing. Several bypass sizes are available (4", 6", 8"). Both plug types are resistant to increased back pressure.



Increased back pressure

Extremely strong aramid reinforcement

Oil-resistant material also available

Several bypass sizes

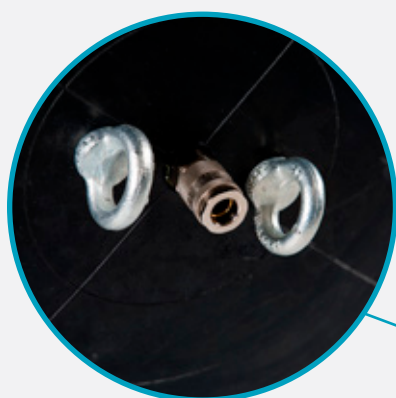

Robust eyebolts and quick coupling



**PLUGY HPF 750-1500**  
(30" – 60")  
545467



Scan the QR code to access technical data:





## PLUGY HP

CODE	TYPE	USAGE RANGE		DEFLATED PLUG		PRESCRIBED INFLATION PRESSURE [bar]	PRODUCT WEIGHT [kg]	EYEBOLT	INFLATION VALVE
		MIN. DIAMETER [mm]	MAX. DIAMETER [mm]	DIAMETER [mm]	RUBBER BODY LENGTH [mm]				
545456	100-200	100	200	92	550	3	1.1	M6	R 1/4"
545457	150-300	150	300	142	590	3	1.9	M8	R 1/4"
545458	200-400	200	400	192	635	3	3.0	M12	R 3/8"
545460	350-600	350	600	322	865	3	8.4	M12	R 3/8"
545463	500-800	500	800	472	1185	3	18.0	M12	R 3/8"
545464	500-1000	500	1000	472	1185	3	18.0	M12	R 3/8"
545465	600-1200	600	1200	574	1500	2.5	39.0	M16	R 1/2"
545467	750-1500	750	1500	600	2300	1.5	65.0	M16	R 1/2"
545783	800-1800	800	1800	600	3000	1.5	105.0	M16	R 1/2"
545458	1000-2400	1000	2400	960	4000	1	320.0	M16	R 1/2"

## PLUGSY HP

CODE	TYPE	USAGE RANGE		DEFLATED PLUG		PRESCRIBED INFLATION PRESSURE [bar]	PRODUCT WEIGHT [kg]	EYEBOLT	INFLATION VALVE	BYPASS DIAMETER
		MIN. DIAMETER [mm]	MAX. DIAMETER [mm]	DIAMETER [mm]	RUBBER BODY LENGTH [mm]					
545468	100-200	100	200	92	550	3	2.6	M6	R 1/4"	1"
545469	150-300	150	300	142	590	3	4.4	M8	R 1/4"	1"
545470	200-400	200	400	192	635	3	6.3	M12	R 3/8"	2"
545472	350-600	350	600	322	865	3	16.6	M12	R 3/8"	2"
545473	500-800	500	800	472	1185	3	31.3	M12	R 3/8"	2"
545474	500-1000	500	1000	472	1185	3	31.3	M12	R 3/8"	2"
545475	600-1200	600	1200	574	1500	2.5	46.6	M16	R 1/2"	4"/6"/8"
545476	750-1500	750	1500	600	2300	1.5	75.0	M16	R 1/2"	4"/6"/8"
545784	800-1800	800	1800	600	3000	1.5	117.0	M16	R 1/2"	4"/6"/8"
545787	1000-2400	1000	2400	960	4000	1	340.0	M16	R 1/2"	4"/6"/8"

## MAX. BACK PRESSURE [BAR]

TYPE/SIZE	PIPE DIAMETER [mm]																				
	100	150	200	250	300	350	400	500	600	800	1000	1200	1300	1400	1500	1600	1700	1800	2000	2200	2400
100-200 3 bar	2.6	2.1	1.7																		
150-300 3 bar		2.6	2.4	1.8	1.6																
200-400 3 bar			2.6	2.4	2.1	1.9	1.6														
350-600 3 bar						2.6	2.5	2.0	1.7												
500-800 3 bar								2.6	2.5	1.7											
500-1000 3 bar								2.6	2.5	1.7	1.0										
600-1200 2.5 bar									2.1	1.9	1.5	1.0									
750-1500 1.5 bar										1.2	1.1	1.0	0.9	0.8	0.7						
800-1800 1.5 bar										1.3	1.2	1.1	1.0	0.9	0.8	0.7	0.6	0.5			
1000-2400 1 bar											0.9	0.9	0.9	0.9	0.8	0.8	0.7	0.7	0.6	0.5	0.5

## 1.6. PLUGS WITH LARGER BYPASSES – PLUGSY VP

Multi-size SAVA PLUGSY VP plugs with larger bypasses cover usage ranges from 4" (100 mm) to 72" (1800 mm). A replaceable rubber body is reinforced with aramid cord for safe and easy work with the plug. Several versions of the plug are available for different application conditions and bypasses.

Bypass diameter  
up to 8"

Replaceable rubber body  
and bypass flange

Stainless  
steel parts



Scan the QR code to access technical data:





**PLUGSY VP**

CODE	TYPE	USAGE RANGE		DEFLATED PLUG		PRESCRIBED INFLATION PRESSURE [bar]	PRODUCT WEIGHT [kg]	EYEBOLT	INFLATION VALVE	BYPASS DIAMETER
		MIN. DIAMETER [mm]	MAX. DIAMETER [mm]	DIAMETER [mm]	RUBBER BODY LENGTH [mm]					
516942	100-150	100	200	88	370	2.5	2.1	M6	not removable	2"
546943	150-250	150	300	136	520	2	4.8	M8	not removable	2"/3"
516944	200-300	200	400	186	550	2	8.3	M8	not removable	2"/4"
533539	300-525	300	525	272	630	2	12.0	M8	R 1/4"	2"/4"/6"
60967	150-300	150	600	142	540	1.5	4.3	M10	R 1/4"	2"
90968	200-400	200	750	192	600	1.5	7.1	M10	R 1/4"	2"/4"
60970	350-600	300	800	322	830	1.5	19.8	M10	R 1/4"	2"/4"/6"
60971	500-1000	500	1000	472	1150	1.5	37.5	M10	R 1/4"	2"/4"/6"/8"
535873	600-1200	600	1200	574	1450	1.5	71.0	M12	2xR 3/8"	6"/8"
535876	750-1500	750	1500	600	2300	1	85.0	M12	2xR 1/2"	6"/8"
535879	800-1800	800	1800	800	3000	1	125.0	M12	2xR 1/2"	6"/8"

## 1.7. CHEMICAL RESISTANT CR-RUBBER PLUGS – PLUGY C AND PLUGSY C

SAVA PLUGY C and PLUGSY C plugs are made from a special CR rubber compound and additionally reinforced with aramid cord. Due to their exceptional resistance to certain chemicals, they are ideal for use in the oil and gas industry.

Different sizes available

Highly resistant to different liquids

Specially developed for use in refineries and food processing industry

CR rubber compound



**PLUGY C 350-525**  
(14"-21")  
526623

Orange dot stands for CR rubber compound



**NOTE:**  
Check the Media Resistance Table in Attachment 3.



Scan the QR code to access technical data:



**PLUGY C**

CODE	TYPE	USAGE RANGE		DEFLATED PLUG		PRESCRIBED INFLATION PRESSURE [bar]	PRODUCT WEIGHT [kg]	EYEBOLT	INFLATION VALVE
		MIN. DIAMETER [mm]	MAX. DIAMETER [mm]	DIAMETER [mm]	RUBBER BODY LENGTH [mm]				
526621	40-70	40	70	35	160	2.5	0.3	NA	R 1/4"
526622	70-150	70	150	68	300	2.5	1.7	NA	R 1/4"
545456	100-200	100	200	92	500	3	1.1	M6	R 1/4"
545457	150-300	150	300	142	540	3	1.9	M8	R 1/4"
545458	200-400	200	400	192	600	3	3.0	M8	R 1/4"
526623	300-525	300	525	272	630	2.5	6.0	M8	R 1/4"
545460	350-600	350	600	322	865	3	8.4	M10	R 1/4"
526624	375-750	375	750	342	1050	2.5	10.9	M10	R 1/4"
545463	500-800	500	800	472	1185	3	18.0	M10	R 1/4"
545464	500-1000	500	1000	472	1185	3	18.0	M10	R 1/4"
545465	600-1200	600	1200	574	1500	2.5	39.0	M10	2×R 3/8"
545467	750-1500	750	1500	600	2300	1.5	65.0	M10	2×R 3/8"
545783	800-1800	800	1800	600	3000	1.5	105.0	M10	2×R 1/2"

**PLUGSY C**

CODE	TYPE	USAGE RANGE		DEFLATED PLUG		PRESCRIBED INFLATION PRESSURE [bar]	PRODUCT WEIGHT [kg]	EYEBOLT	INFLATION VALVE	BYPASS DIAMETER
		MIN. DIAMETER [mm]	MAX. DIAMETER [mm]	DIAMETER [mm]	RUBBER BODY LENGTH [mm]					
526637	100-200	100	200	92	500	2.5	2.6	M6	R 1/4"	1"
526636	150-300	150	300	142	540	2.5	4.4	M8	R 1/4"	1"
526635	200-400	200	400	192	600	2.5	6.3	M8	R 1/4"	2"
526634	300-525	300	525	272	630	2.5	11.9	M8	R 1/4"	2"
526633	350-600	350	600	322	830	2.5	16.0	M10	R 1/4"	2"
526631	375-750	375	750	342	1050	2.5	64.0	M10	R 1/4"	2"
526629	500-800	500	800	472	1150	2.5	19.7	M10	R 1/4"	2"
526628	500-1000	500	1000	472	1150	2.5	31.3	M10	R 1/4"	2"
526627	600-1200	600	1200	574	1450	2.5	31.3	M10	2×R 3/8"	4"
529446	750-1500	750	1500	600	2300	2.5	60.0	M10	2×R 3/8"	4"
581132	800-1800	800	1800	600	3000	1.5	75.0	M10	2×R 1/2"	4"

## 1.8. CHEMICAL RESISTANT NBR-RUBBER PLUGS – PLUGY NBR

SAVA PLUGY NBR plugs are made from a special NBR rubber compound and additionally reinforced with aramid cord. Due to their extreme resistance to certain chemicals, they are ideal for use in the oil and gas industry.

NBR rubber compound

Highly resistant to different liquids

Developed specifically for use in refineries and food processing industry

Stainless steel parts

### HIGHLY RESISTANT TO:

- most mineral oils and mineral based lubricants,
- common fuels such as gasoline, diesel and light heating oil,
- animal and vegetable oils and fats,
- temperatures from  $-10^{\circ}\text{C}$  ( $14^{\circ}\text{F}$ ) to  $+80^{\circ}\text{C}$  ( $176^{\circ}\text{F}$ ).

PLUGY NBR 300-525  
(12"-21")  
596490

Green dot stands for NBR rubber.

Rubber body from NBR rubber

Stainless steel eyebolts and quick coupling



Scan the QR code to access technical data:



**PLUGSY NBR**

CODE	TYPE	USAGE RANGE		DEFLATED PLUG		PRESCRIBED INFLATION PRESSURE [bar]	PRODUCT WEIGHT [kg]	INFLATION VALVE	BYPASS DIAMETER
		MIN. DIAMETER [mm]	MAX. DIAMETER [mm]	DIAMETER [mm]	RUBBER BODY LENGTH [mm]				
596487	100-200	100	200	92	500	2.5	1.3	M6	R 1/4"
596488	150-300	150	300	142	540	2.5	2.6	M8	R 1/4"
596489	200-400	200	400	192	600	2.5	3.6	M8	R 1/4"
596490	300-525	300	525	272	630	2.5	6.8	M8	R 1/4"
596491	350-600	350	600	322	830	2.5	9.8	M10	R 1/4"
596492	500-800	500	800	472	1150	2.5	28	M10	R 1/4"
602226	500-1000	500	1000	472	1150	1.5	28	M10	R 1/4"
596493	600-1200	600	1200	574	1450	1.5	45.5	M10	R 1/4"



## 1.9. CONICAL PLUGS – PLUGY CP AND PLUGSY CP

SAVA PLUGY CP and PLUGSY CP plugs are made from a special CR rubber compound and reinforced with textile. They are available in sizes from 16"–95" (400 mm to 2400 mm). Additional sealing foam further improves sealing in all application conditions. They are fitted with handles and rings for easy handling. Very light and suitable for sealing pipes of different shapes (conical, oval, etc.).

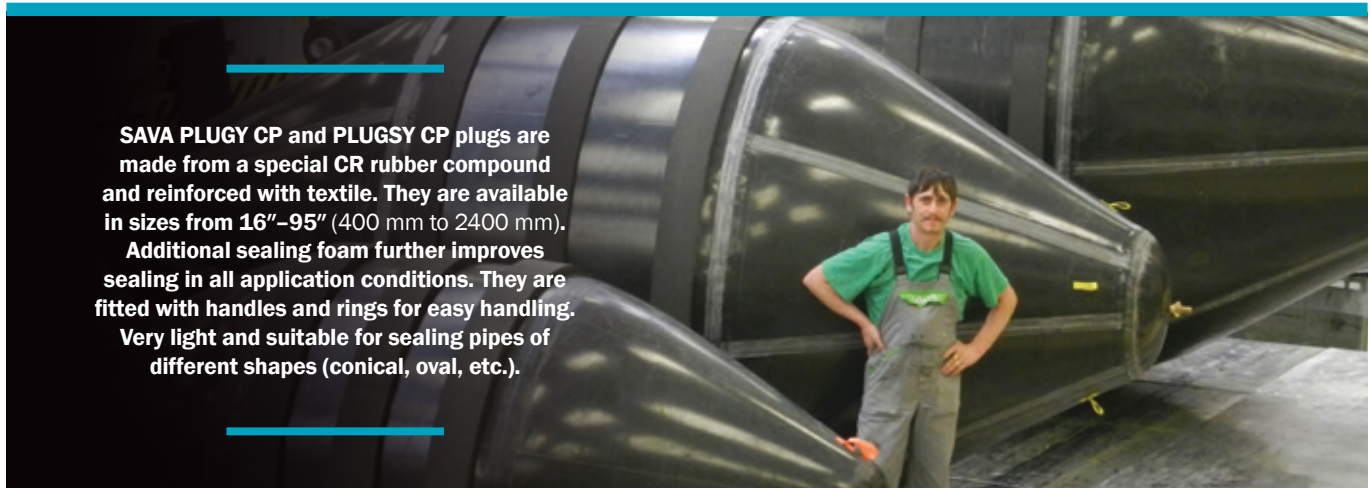

Reparable material

Wide range of application

Tapered shape

Lightweight design

Rings



Special sealing foam

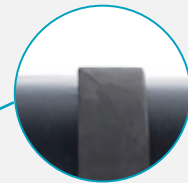

Handles for handling



PLUGY CP 700-2000  
(28"–79")  
574342



Scan the QR code to access technical data:



**CONE PLUGY**

CODE	TYPE	USAGE RANGE		INFLATION PRESSURE [bar]	DEFLATED PLUG		BACK PRESSURE [bar]	INFLATION VALVE
		MIN. DIAMETER [mm]	MAX. DIAMETER [mm]		LENGTH [mm]	WEIGHT [mm]		
574340	400-1000	400	1000	1.0	2000	17	0.5	R 1/2"
574341	600-1500	600	1500	1.0	3000	36	0.5	R 1/2"
574342	700-2000	700	2000	1.0	4000	84	0.5	R 1/2"
574343	900-2400	900	2400	1.0	4800	100	0.5	R 1/2"



## 1.10. ROUND PLUGS – PLUGSY B-VP

**SAVA PLUGSY B-VP plugs are available in sizes from 16"–60" (400 mm to 1500 mm). They are used to reduce the pipeline diameter and control of the water flow, which is diverted by standard PVC pipes. Due to their large bypass, the use of a pump is only rarely required.**

Highly flexible

Lightweight design

Large bypass system

PLUGSY B-VP  
591443

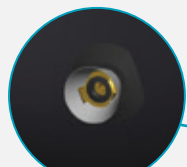

GEKA  
coupling

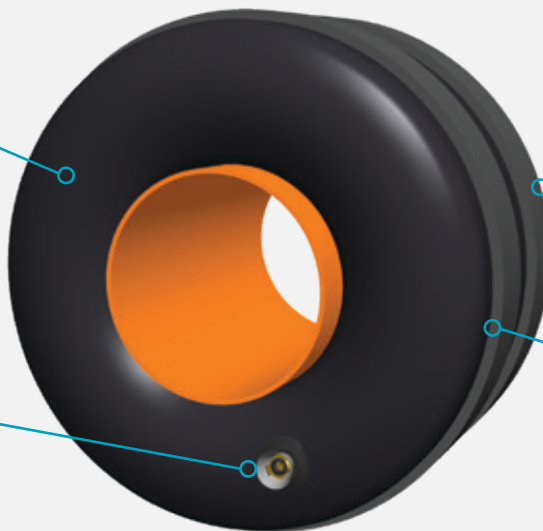

Rear view



Special sealing foam

\*PVC pipe not included.



Scan the QR code to access technical data:



**PLUGSY B-VP**

CODE	TYPE	USAGE RANGE		INFLATION PRESSURE [bar]	DEFLATED PLUG		BYPASS DIAMETER	INFLATION VALVE
		MIN. DIAMETER [mm]	MAX. DIAMETER [mm]		LENGTH [mm]	WEIGHT [mm]		
<b>591443</b>	400-1000	400	1000	1.0	2000	16	250	R 1/2"
<b>591445</b>	600-1500	600	1500	1.0	3000	18	460	R 1/2"

### 1.11. PILLOW PLUGS – PLUGY PILLOW AND PLUGSY PILLOW

Thanks to their unique design and high-quality materials, SAVA PLUGY PILLOW and PLUGSY PILLOW plugs are light in weight and highly adaptable both during use and storage. They are particularly suitable for the largest pipelines diameters. These plugs can be made to order for the desired pipeline diameter.

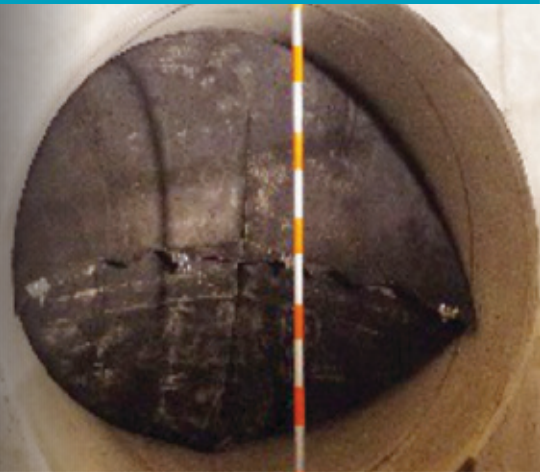

**Flexible and fully foldable**

**For small inlets**

**Suitable for manholes  
24" (600 mm)**

**Sizes made to order**



**Deflated plug**



**Folded plug**



**PLUGY PILLOW 600-1000  
(24"-40")  
529411**



Scan the QR code to access technical data:



**PLUGY PILLOW - BLOCKING PLUGS**

CODE	TYPE	USAGE RANGE		INFLATION PRESSURE [bar]	MAX. BACK PRESSURE PERMITTED		DEFLATED PLUG			PRODUCT WEIGHT [kg]	EYEBOLT	
		MIN. DIAMETER [mm]	MAX DIAMETER [mm]		WATER COLUMN [bar]	WATER COLUMN [m]	DIAMETER [mm]	WIDTH [mm]	LENGTH [mm]		THREAD M	INFLATION VALVE
<b>529411</b>	600-1000	600	1000	1	0.7	7	580"	910	2100	18	12 × 2	2 × R1/2"
<b>529412</b>	800-1200	800	1200	0.9	0.6	6	780	1230	2500	29	12 × 2	2 × R1/2"
<b>529413</b>	1200-1600	1200	1600	0.8	0.5	5	1170	1830	3200	51	12 × 3	2 × R1/2"
<b>529414</b>	1600-2000	1600	2000	0.6	0.4	4	1560	2450	4000	86	12 × 3	2 × R1/2"
<b>529491</b>	1900-2200	1900	2200	0.5	0.3	3	1850	2910	4800	100	12 × 4	2 × R1/2"
<b>545429</b>	2400-2500	2400	2500	0.5	0.3	3	2350	3690	5600	222	12 × 6	2 × R1/2"

**PLUGSY PILLOW - BYPASS PLUGS**

CODE	TYPE	USAGE RANGE		INFLATION PRESSURE [bar]	MAX. BACK PRESSURE PERMITTED		DEFLATED PLUG			PRODUCT WEIGHT [kg]	EYEBOLT		BYPASS DIAMETER [inner]
		MIN. DIAMETER [mm]	MAX DIAMETER [mm]		WATER COLUMN [bar]	WATER COLUMN [m]	DIAMETER [mm]	WIDTH [mm]	LENGTH [mm]		THREAD M	INFLATION VALVE	
<b>529415</b>	600-1000	600	1000	1	0.7	7	580"	910	2100	18	12 × 2	2 × R1/2"	2"
<b>529416</b>	800-1200	800	1200	0.9	0.6	6	780	1230	2500	29	12 × 2	2 × R1/2"	2"
<b>529417</b>	1200-1600	1200	1600	0.8	0.5	5	1170	1830	3200	51	12 × 3	2 × R1/2"	2"
<b>529418</b>	1600-2000	1600	2000	0.6	0.4	4	1560	2450	4000	86	12 × 3	2 × R1/2"	2"
<b>529492</b>	1900-2200	1900	2200	0.5	0.3	3	1850	2910	4800	100	12 × 4	2 × R1/2"	2"
<b>545433</b>	2400-2500	2400	2500	0.5	0.3	3	2350	3690	5600	222	12 × 6	2 × R1/2"	2"

## 1.12. OVAL PLUGS – PLUGY EI (PILLOW) AND PLUGSY EI (PILLOW)

The shape of the first two sizes is adapted to the shape of the pipeline, while the larger plugs are pillow-shaped for easier insertion through the manholes. Seven standard sizes are available in both blocking and bypass design.

Suitable for standard oval tubes

Two designs

Wide usage range

### EI DESIGN (FOR SMALL SIZES)

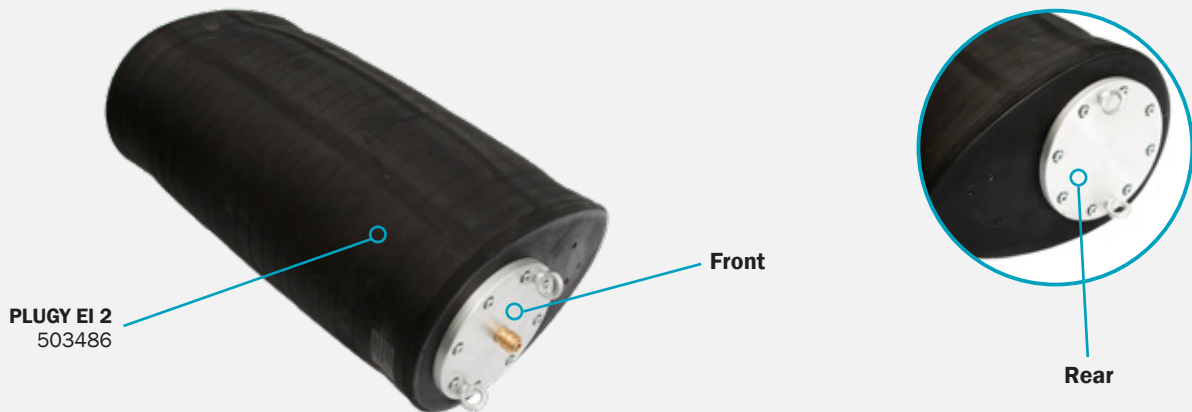

### EI PILLOW DESIGN (FOR LARGER SIZES)



Scan the QR code to access technical data:



**PLUGY EI - BLOCKING PLUGS**

CODE	TYPE	USAGE RANGE		INFLATION PRESSURE	MAX. BACK PRESSURE PERMITTED		DEFLATED PLUG			PRODUCT WEIGHT	EYEBOLT	SHACKLE	INFLATION VALVE
		MIN. DIAMETER	MAKS. DIAMETER		WATER COLUMN	WATER COLUMN	DIAMETER	WIDTH	LENGTH		THREAD M	THREAD M	
		[mm]	[mm]	[bar]	[bar]	[m]	[mm]	[mm]	[mm]	[kg]			
503485	EI 1	200/300	250/375	1.5	0.5	5	180×265	/	600	7	8	not available	TYPE 26
503486	EI 2	300/450	350/525	1.5	0.5	5	280×415	/	700	14.8	8	not available	TYPE 26
526694	EI 3 - PILLOW	400/600	500/750	1.3	0.5	5	420	660	1800	20.1	not available	12 × 2	2 × R1/2"
568807	EI 3s - PILLOW	600/900	600/900	1.3	0.5	5	636	1000	1800	26.7	not available	12 × 2	2 × R1/2"
519444	EI 4 - PILLOW	700/1050	800/1200	0.9	0.5	5	751	1180	2300	36.1	not available	12 × 2	2 × R1/2"
519447	EI 5 - PILLOW	900/1350	1000/1500	0.8	0.5	5	955	1500	2900	53.9	not available	12 × 3	2 × R1/2"
536345	EI 6 - PILLOW	1200/1800	1400/2100	0.6	0.5	4	1394	2190	3400	92.4	not available	12 × 3	2 × R1/2"

**PLUGSY EI - BYPASS PLUGS**

CODE	TYPE	USAGE RANGE		INFLATION PRESSURE	MAX. BACK PRESSURE PERMITTED		DEFLATED PLUG			PRODUCT WEIGHT	EYEBOLT	SHACKLE	BYPASS DIAMETER
		MIN. DIAMETER	MAKS. DIAMETER		WATER COLUMN	WATER COLUMN	DIAMETER	WIDTH	LENGTH		THREAD M	THREAD M	
		[mm]	[mm]	[bar]	[bar]	[m]	[mm]	[mm]	[mm]	[kg]			
504158	EI 1	200/300	250/375	1.5	0.5	5	180×265	/	600	10.2	8	not available	2"
504160	EI 2	300/450	350/525	1.5	0.5	5	280×415	/	700	17.9	8	not available	3"
526695	EI 3 - PILLOW	400/600	500/750	1.3	0.5	5	420	660	1800	25.4	not available	12 × 2	2"
568808	EI 3s - PILLOW	600/900	600/900	1.3	0.5	5	636	1000	1800	32.1	not available	12 × 2	2"
519448	EI 4 - PILLOW	700/1050	800/1200	0.9	0.5	5	751	1180	2300	42.1	not available	12 × 2	2"
519449	EI 5 - PILLOW	900/1350	1000/1500	0.8	0.5	5	955	1500	2900	60.8	not available	12 × 3	2"
536350	EI 6 - PILLOW	1200/1800	1400/2100	0.6	0.4	4	1394	2190	3400	100.9	not available	12 × 3	2"



### 1.13. PLUGS FOR MANHOLE TESTING – PLUGSY VJ



Suitable for testing according to EN 1610

Manhole-specific design

Simple handling

Highly durable

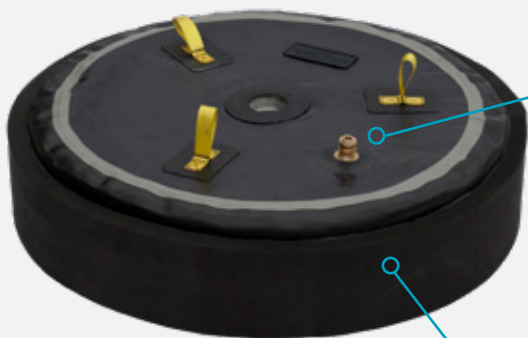

**PLUGSY VJ 800 (32")**  
535889

**PLUGSY VJ – INDIVIDUAL SIZES**  
(VJ 600, VJ 800, VJ 1000)



**Special sealing and protective foam**

**PLUGSY VJ 600-650 (24"-26")**  
501841



**PLUGSY VJ – MULTI-SIZE DESIGN**



Scan the QR code to access technical data:





**PLUGY VJ**

CODE	TYPE	USAGE RANGE		DEFLATED PLUG		PRESCRIBED INFLATION PRESSURE [bar]	MAX. BACK PRESSURE [bar]	PRODUCT WEIGHT [kg]	BYPASS DIAMETER	INFLATION VALVE
		MIN. DIAMETER [mm]	MAX. DIAMETER [mm]	DIAMETER [mm]	RUBBER BODY LENGTH [mm]					
<b>501841</b>	600/650	600	650	560	360	1.5	0.3	16.0	2"	R 1/4"
<b>538201</b>	600	600	600	582	200	0.5	0.1	3.7	2"	R 1/4"
<b>573713</b>	700	800	800	670	200	0.5	0.1	4.6	2"	R 1/4"
<b>535889</b>	800	800	800	770	200	0.5	0.1	5.0	2"	R 1/4"
<b>535890</b>	1000	1000	1000	970	200	0.5	0.1	6.5	2"	R 1/4"

## 1.14. HIGH-PRESSURE PLUGS – PLUGY HP 6, 12, 30 bar

SAVA PLUGY HP plugs with special reinforcement for sealing of pipelines in which extremely high back pressure builds up.



Special reinforcement

High back pressure

Highly durable

**PLUGY HP 6 bar** (435 psi)  
**350-500** (14"-20")  
60909



**PLUGY HP 6 bar** (87 psi), **12 bar** (174 psi)

**PLUGY HP 30 bar** (435 psi) **DESIGN**

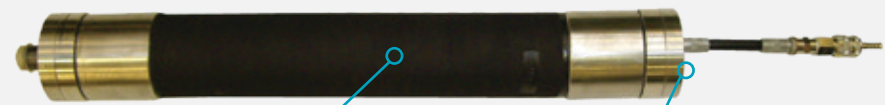

**PLUGSY HP 30 bar** (435 psi)  
537323



Front view



Scan the QR code to access technical data:



### PLUGY HP 6 BAR

CODE	TYPE	USAGE RANGE		DEFLATED PLUG		PRESCRIBED INFLATION PRESSURE [bar]	PRODUCT WEIGHT [kg]	EYEBOLT	THREAD SIZE OF INFLATION VALVE	MAX.BACK PRESSURE
		MIN. DIAMETER [mm]	MAX. DIAMETER [mm]	DIAMETER [mm]	RUBBER BODY LENGTH [mm]					
60887	100-150	100	150	92	535	6	1.2	M6	R 1/4"	3
60907	150-200	150	200	142	575	6	2.0	M8	R 1/4"	3
60908	200-300	200	300	192	635	6	3.2	M8	R 1/4"	3
60909	350-500	350	500	322	865	6	8.7	M8	R 1/4"	3
60924	500-600	500	600	472	1185	6	18.0	M10	R 1/4"	3

### PLUGY HP 12 BAR

CODE	TYPE	USAGE RANGE		DEFLATED PLUG		PRESCRIBED INFLATION PRESSURE [bar]	PRODUCT WEIGHT [kg]	EYEBOLT	THREAD SIZE OF INFLATION VALVE	MAX.BACK PRESSURE
		MIN. DIAMETER [mm]	MAX. DIAMETER [mm]	DIAMETER [mm]	RUBBER BODY LENGTH [mm]					
518561	100-125	100	125	92	535	12	1.5	M6	R 1/4"	10
518562	150	150	150	142	575	12	2.7	M8	R 1/4"	10
518563	200-250	200	250	192	635	12	4.3	M8	R 1/4"	10
518564	300-350	300	350	272	670	12	8.0	M8	R 1/4"	10
518565	400	400	400	322	865	12	11.5	M10	R 1/4"	10
518566	500	500	500	472	1185	12	24.1	M10	R 1/4"	10

### PLUGY HP 30 BAR

CODE	TYPE	USAGE RANGE		DEFLATED PLUG		PRESCRIBED INFLATION PRESSURE [bar]	PRODUCT WEIGHT [kg]	MAX.BACK PRESSURE	PLUG LENGTH
		MIN. DIAMETER [mm]	MAX. DIAMETER [mm]	DIAMETER [mm]	RUBBER BODY LENGTH [mm]				
538625	55-75	55	75	54	400	30	3.0	16	615
533837	75-100	75	100	73	400	30	5.0	16	600
533838	100-150	100	150	88	400	30	6.7	16	614
533839	150-200	150	200	122	400	30	13.0	16	621

### PLUGSY HP 30 BAR

CODE	TYPE	USAGE RANGE		DEFLATED PLUG		PRESCRIBED INFLATION PRESSURE [bar]	PRODUCT WEIGHT [kg]	MAX.BACK PRESSURE	THREAD SIZE OF INFLATION VALVE	BYPASS SIZE [mm]
		MIN. DIAMETER [mm]	MAX. DIAMETER [mm]	DIAMETER [mm]	RUBBER BODY LENGTH [mm]					
537553	55-75	55	75	54	400	30	4.0	16	3/8"	10
537661	75-100	75	100	73	400	30	6.0	16	1/2"	15
537323	100-150	100	150	88	400	30	8.0	16	3/4"	20
537672	150-200	150	200	122	400	30	14.0	16	1"	25

## 1.15. HOUSE CONNECTION LEAK TEST KIT

SAVA house connection leak test kit is used for leak testing of house connections, fixtures and sewage drains, with either water or air, in accordance with the DIN EN 1610 standard. The test kit is easy to use and ensures efficient testing, as both plugs allow simultaneous inflation from one place. Connecting hoses of different lengths enable quick adjustment of the spacing between the two plugs. The product is known for its easy and reliable use, and minimum air volume requirement.

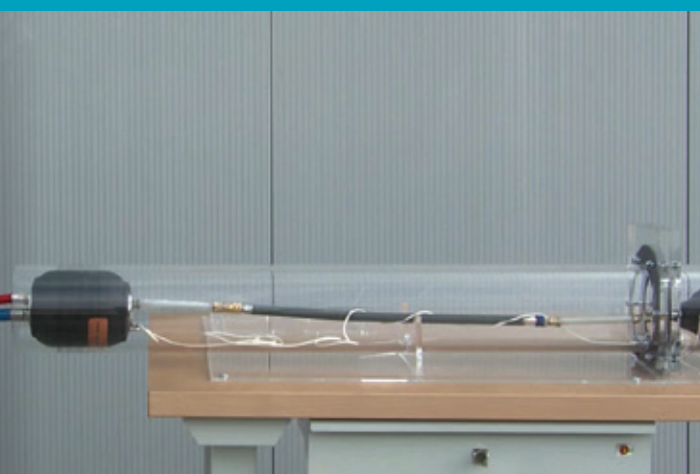

Suitable for testing according to EN 1610

Simultaneous inflation of both plugs

Simple handling and use

High-quality materials



XL TEST KIT (COMBINED)

- Simultaneous inflation of both plugs.
- Small, compact and light bypass plugs with hoses of different colours

PLUGSY 100-150  
(4"-6")  
562158

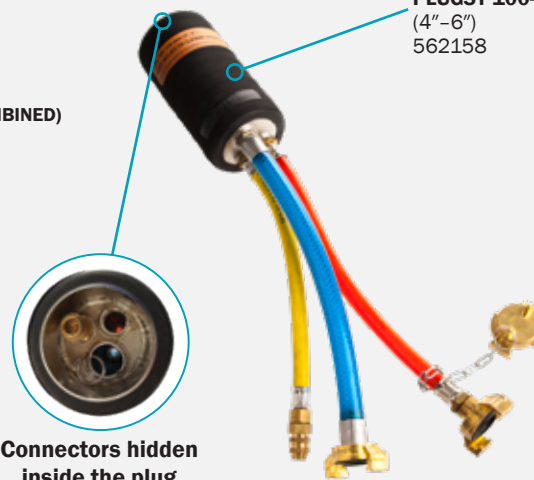

Connectors hidden inside the plug

### ADVANTAGES

- Extremely light and flexible blocking plug.
- Handy and simple to use venting floater.
- Highly flexible push rods.
- Small, compact and light carrying case, impact and weather resistant.



Scan the QR code to access technical data:



**PLUGS FOR TESTING OF HOUSE CONNECTIONS**

CODE	TYPE	USAGE RANGE		DEFLATED PLUG		PRESCRIBED INFLATION PRESSURE [bar]	MAX. BACK PRESSURE [bar]	PRODUCT WEIGHT [kg]
		MIN. DIAMETER [mm]	MAX. DIAMETER [mm]	DIAMETER [mm]	RUBBER BODY LENGTH [mm]			
<b>562158</b>	100-150	100	150	80	160	2.5	0.2	1.5
<b>564063</b>	100-150	100	150	98	420	2.5	1.0	0.6
<b>562159</b>	150-210	150	210	120	180	2.5	0.2	2.9
<b>564064</b>	150-210	150	210	140	510	2.5	1.0	0.8

## 1.16. PROTECTIVE SLEEVES FOR PLUGS

SAVA protective sleeves prevent surface cuts and damage to the plugs that could result from sharp objects or foreign particles in damaged pipes. They do not affect the back pressure value in the plug. Protective sleeves extend the plug's service life, which is particularly important in case of frequent use, e.g. lending equipment. The product complies with standard sizes of our plug range. Using the handles on both sides, the protective sleeve can be pulled over the plug.



Extra protection of the plug against damage

Handles for easier installation

Oil-resistant material also available

For standard plug sizes

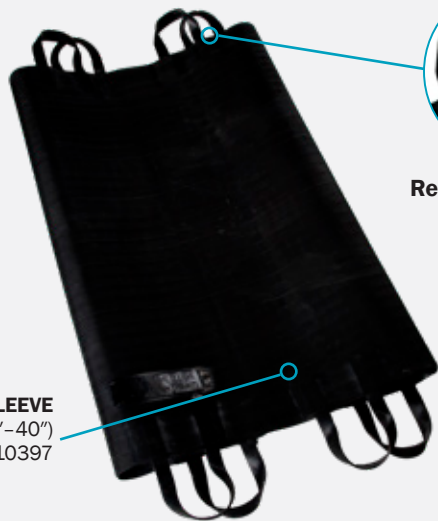

PROTECTIVE SLEEVE  
500-1000 (20"-40")  
510397

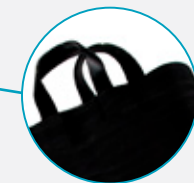

Reinforced handles



A protective sleeve can be placed on a deflated pneumatic plug only. It should be pulled over the plug by hand; the use of construction machinery is strictly forbidden.



Scan the QR code to access technical data:



**PLUGS FOR TESTING HOUSE CONNECTIONS**

CODE	TYPE	USAGE RANGE		DEFLATED PLUG		PRESCRIBED INFLATION PRESSURE [bar]	MAX. BACK PRESSURE [bar]	PRODUCT WEIGHT [kg]
		MIN. DIAMETER [mm]	MAX. DIAMETER [mm]	DIAMETER [mm]	RUBBER BODY LENGTH [mm]			
<b>562158</b>	100-150	100	150	80	160	2.5	0.2	1.5
<b>564063</b>	100-150	100	150	98	420	2.5	1.0	0.6
<b>562159</b>	150-210	150	210	120	180	2.5	0.2	2.9
<b>564064</b>	150-210	150	210	140	510	2.5	1.0	0.8



## 1.17. ACCESSORIES

### AIR LEAK TEST EQUIPMENT



**ADAPTER R1",  
2× QUICK COUPLING**  
60449



**ADAPTER R2", WITH GEKA  
AND QUICK COUPLING**  
60450

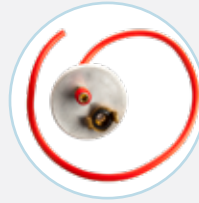

**ADAPTER R4", WITH GEKA  
AND QUICK COUPLING**  
60443



**INFLATION HOSE 8 mm I.D., WITH  
QUICK COUPLING FOR PIPELINE  
FILLING**  
5 m (16,4')  
76684



**INFLATION HOSE 19 mm I.D.,  
WITH GEKA COUPLING FOR  
PIPELINE FILLING**  
5 m (16,4'),  
60452



**MEASURING HOSE WITH  
NIPPLE AND GAUGE, RED**  
0-0,6 bar (0-9 psi), 10 m (33')  
78070



**SINGLE FITTING CONTROLLER**  
2,5 bar (36 psi) 60310  
1,5 bar (22 psi) 74609  
1,0 bar (15 psi) 74653



**INFLATION HOSE,  
YELLOW**  
10 m (33')  
76686



**HAND PUMP**  
60010

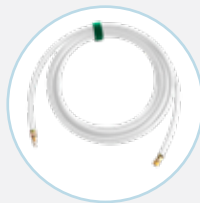

**INFLATION HOSE,  
TRANSPARENT,**  
5 m (16,4'),  
78905



Scan the QR code to access technical data:



## WATER LEAK TEST EQUIPMENT



**ADAPTER, STORZ D, TEST AND MEASURING HOSE,**  
6 m (19,7')  
60407



**ADAPTER, STORZ C, TEST AND MEASURING HOSE,**  
6 m (19,7')  
60412



**ADAPTER, STORZ A, TEST AND MEASURING HOSE,**  
6 m (19,7')  
60438



**STORZ COUPLING**  
D 60380  
C 60388  
A 60428



**VENTING FLOATER HOSE R 1"**  
60446



**VENTING FLOATER HOSE R 2"**  
60448



**VENTING FLOATER HOSE R 4"**  
60439



**INFLATION HOSE, YELLOW**  
10 m (33')  
76686



**SINGLE FITTING CONTROLLER**  
2,5 bar (36 psi) 60310  
1,5 bar (22 psi) 74609  
1,0 bar (15 psi) 74653



**HAND PUMP**  
0,8 kg (1,8 lbs)  
60010

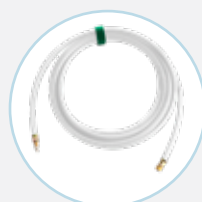

**INFLATION HOSE, TRANSPARENT**  
5 m (16,4')  
78905



Scan the QR code to access technical data:



## ATTACHMENT 5: PILLOW PLUGS, CONICAL PLUGS, HOUSE CONNECTION TEST KIT, AIR LEAK TEST, WATER LEAK TEST

Attachment 5 describes various situations when using pneumatic plugs, using different examples.





A protective sleeve can be placed on a deflated pneumatic plug only. It should be pulled over the plug by hand; the use of construction machinery is strictly forbidden.

### 1.1. PILLOW PLUGS

#### 1.1.1. STEPS FOR USING PILLOW PLUGS

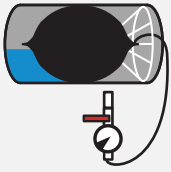
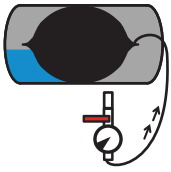
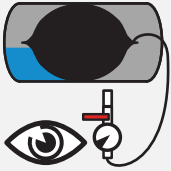
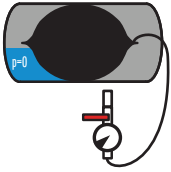
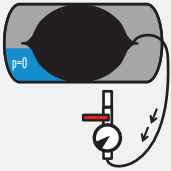
	ILLUSTRATION	PROCEDURE	WARNING
1.		Measure the diameter of the pipe and choose the right pillow pneumatic plug.	Refer to the technical data and back pressure table to choose the right plug.
2.		Check and prepare at the site: air source, plug, calibrated controller, air hoses.	Prior to using the plug, thoroughly check the plug and the accessories. If the plug or the accessories are damaged, they should be removed from service and replaced.
3.		Clean the pipe in which the plug will be used.	Even the smallest sharp particles in the uncleaned pipe may damage the plug.
4.		Fold the two longer sides of the plug towards the centre.	When folding the plug in the pipe, take care not to damage the plug.
5.		Insert the pneumatic plug into the pipe.	When inserting the plug into the pipe, take care not to damage the plug. Position it horizontally.

ILLUSTRATION	PROCEDURE	WARNING
6. 	Set up the safety support for the plug. The way of setting-up depends on the specific situation, in which the plug is used.	Failure to use the support may cause injuries to people in case the back pressure is exceeded. The metal components on the plug are not intended for attaching the plug or setting-up the safety supports.
7. 	Inflate the plug until it reaches the maximum working pressure indicated on the plug.	Staying near the pressurized plug is forbidden. Do not exceed the maximum working pressure indicated on the plug.
8. 	Check the pressure in the plug throughout the work.	Staying near the pressurized plug is forbidden. Do not exceed the maximum working pressure indicated on the plug.
9. 	When you finish the work, release the back pressure.	If the plug is deflated prior to releasing the back pressure, it may move unexpectedly in direction of the back pressure action.
10. 	Empty the plug.	Double-check for the back pressure just before the deflation. If the plug is still pressurized, follow Step 9.
11. 	After use, clean and store the deflated plug and the accessories as instructed.	Follow the instructions for cleaning and storage of pneumatic plugs.
12. 	Thoroughly check the plug and the accessories.	Remove any damaged plug or the accessories from further use and replace them.

### 1.1.2. SITUATIONS THAT MAY ARISE DURING USE OF PILLOW PLUGS

Insert the right plug in the selected place in the pipe and connect it to the inflation hose, calibrated controller and the air source. The plug and the accessories should be inspected and proven faultless. Clean the pipe properly. Water in the pipe should flow freely, as shown in Figure 1.

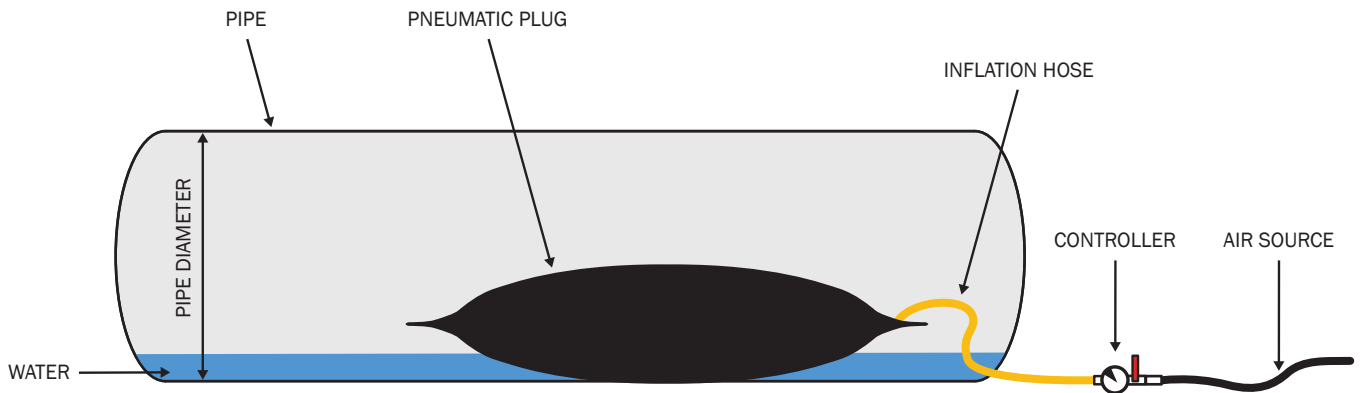

Figure 1

Once the plug is inserted in the pipe, inflate it until it reaches the prescribed working pressure. Use the calibrated controller. The plug is ready for use. Water starts to accumulate behind the plug while the back pressure behind the plug increases, resulting in a force that acts on the plug. The force is in proportion to the pressure and the pipe's surface behind the plug. Note that extremely high forces may develop (Figure 2).

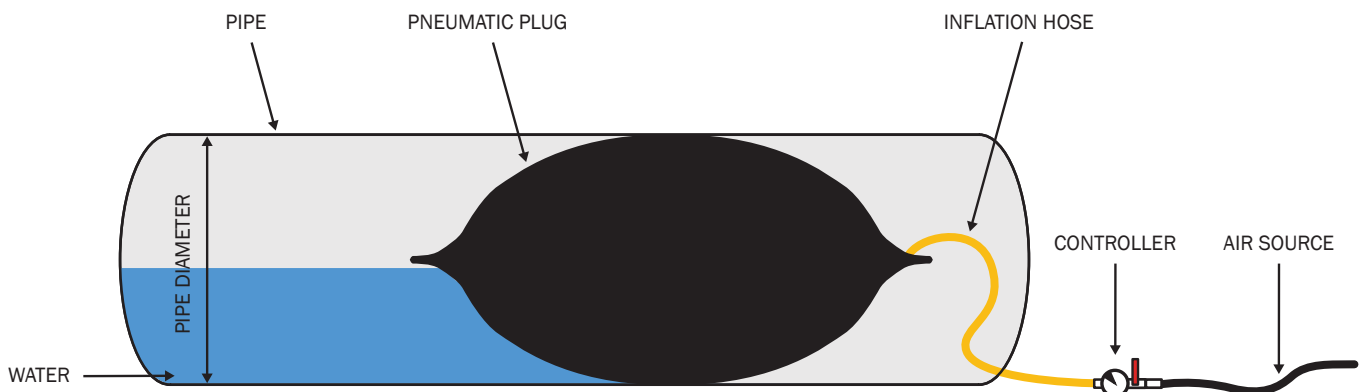

Figure 2

The resulting situation is presented in Figure 3. Using the calibrated controller, the plug is inflated to the prescribed working pressure in the cleaned pipe of a suitable diameter. The pressure in the plug distributes evenly over the entire surface of the plug. The contact surface between the plug and the pipe is marked in red. Coefficient of friction between contact surfaces of the plug and the pipe ensures the function of the plug. The back pressure values given in the table apply to dry metal pipes. If a pipe is wet or oily, coefficient of friction may be lower, which reduces the maximum back pressure the plug can resist. Water starts to accumulate behind the plug, creating the back pressure acting on the plug. The back pressure is distributed according to the principles of hydrostatic pressure, meaning that the pressure at the top of the liquid is lower than the one at the bottom of the liquid, irrespective of the shape. The maximum back pressure to be expected when using the plug is determined with the pipe's diameter and the working pressure in the plug; it must not be exceeded. For safety reasons, we therefore recommend the installation of the system behind the plug that maintains a constant water level and thus prevents an uncontrolled increase in back pressure (Figure 4). We recommend using safety supports when back pressure is expected to build up behind the plug.

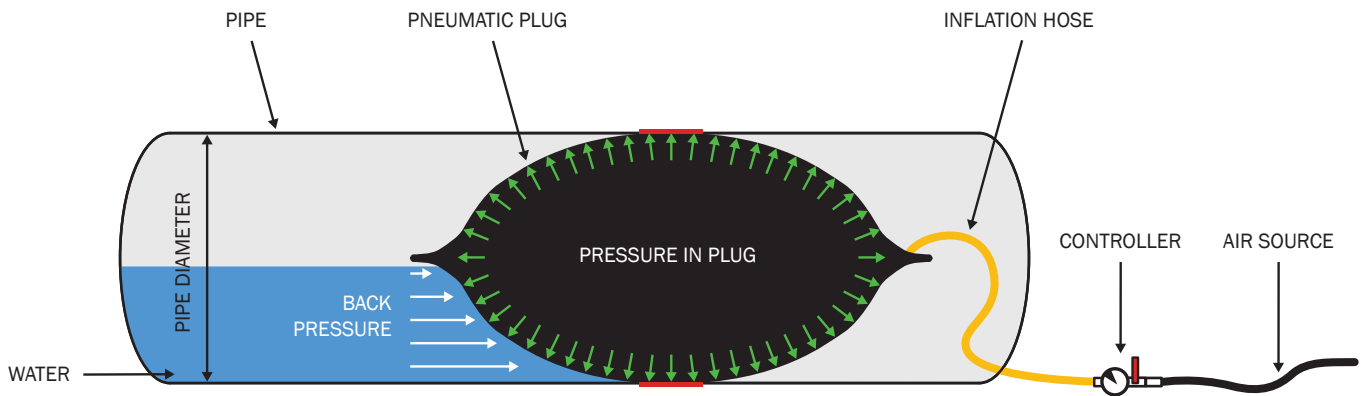

Figure 3

**Situation: the back pressure is higher than expected**

If the instructions are fully complied with, such a situation cannot occur; however, if it does, it is extremely dangerous and requires immediate action. Immediately reduce the pressure behind the plug by limiting or shutting off water inflow behind the plug and start pumping water immediately (e.g. with a submersible pump of appropriate rating). If not, the back pressure will begin to increase and, consequently, the total force acting on the plug will increase too. The plug may move or burst, which may have catastrophic consequences. We recommend using safety supports when back pressure is expected to build up behind the plug. The way of setting up the supports depends on the specific situation, in which the plug is used.

Failure to do so may result in a sudden, unexpected burst of the plug. Change is instantaneous with a huge amount of air released, accompanied by a loud bang. Bursting may have catastrophic consequence and may lead to injuries. The plug is no longer suitable for use.

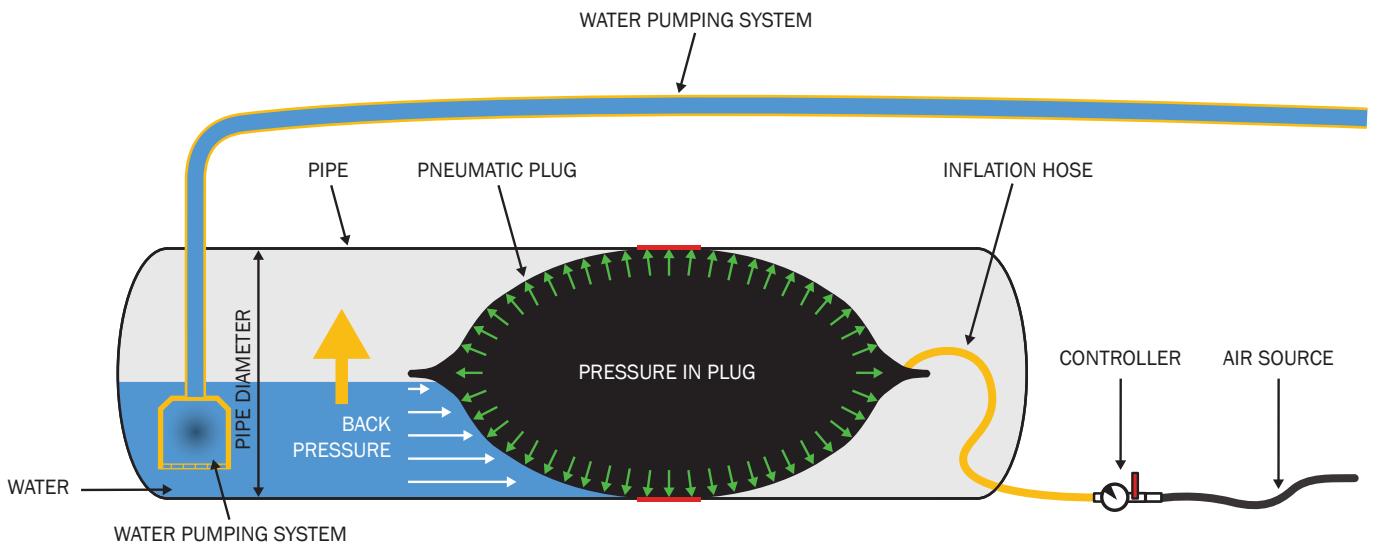

Figure 4

**Situation: the working pressure in the plug is higher than expected**

If the instructions are fully complied with, such a situation cannot occur; however, if it does, it is extremely dangerous and requires immediate action. If the working pressure is exceeded, the safety valve on the calibrated controller is activated to release the excessive pressure. The activated safety valve audibly alerts the user of exceeded working pressure. When the plug is inflated, the pressure in the plug begins to rise extremely slowly while the plug expands until it reaches the inner diameter of the pipe. The closer the plug is to the final diameter and shape of the pipe, the faster the pressure in the pipe increases, which is why the inflation procedure should be slowed down and pressure repeatedly checked (Figure 5).

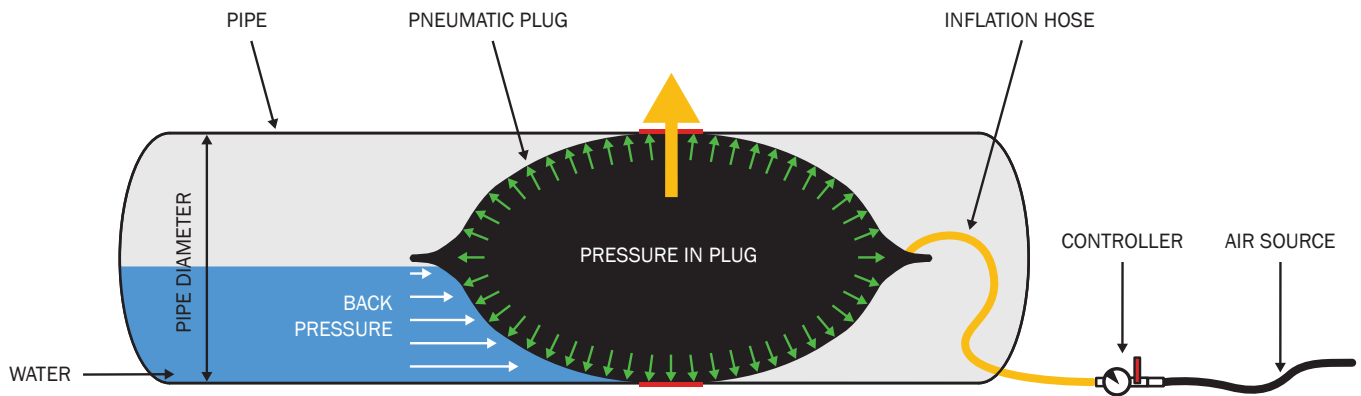

Figure 5

If the pressure change is too rapid (which can happen when the plug is being inflated without supervision), the safety valve fails to provide sufficient release of excessive pressure, which is why the pressure in the plug rises beyond the permitted value. Although the product is designed to have a built-in safety feature against bursting, the plug may rupture. The consequences of plug bursting can be catastrophic. If noticing a sudden rise in the working pressure (usually during inflation), stop the procedure immediately and make sure for the pressure in the plug to be safely reduced. Find out the cause of the pressure rising too quickly and fix the fault.

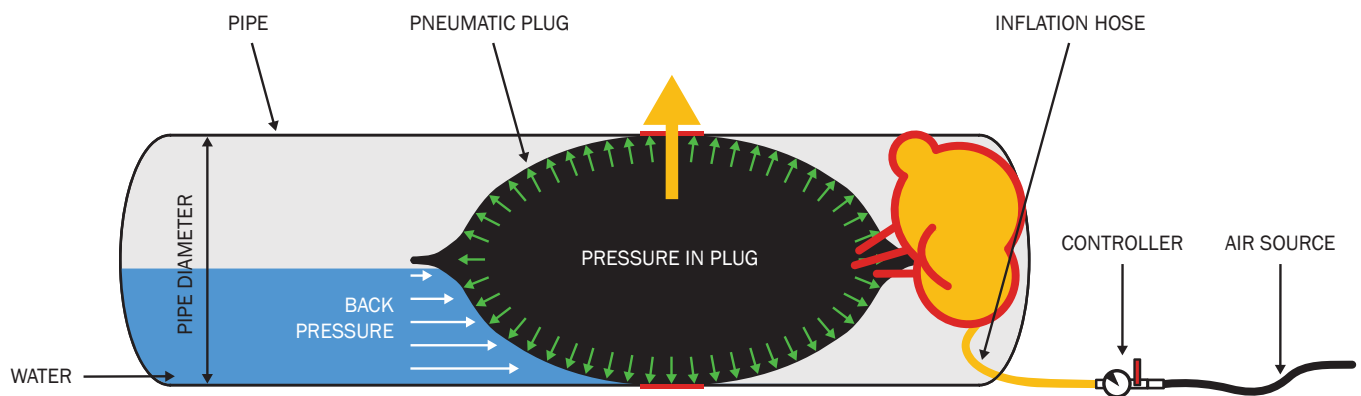

Figure 6

Failure to do so may result in sudden, unexpected burst of the plug. Change is instantaneous with a huge amount of air released, accompanied by a loud bang. Bursting of the plug may have catastrophic consequence and may lead to injuries (Figure 6). The plug is no longer suitable for use.

**Situation: the working pressure in the plug is too low, the back pressure builds up behind the plug**

If the instructions are fully complied with, such a situation cannot occur; however, if it does, it is extremely dangerous and requires immediate action. It can occur if the pressure in the plug drops slowly (e.g. leaking of the plug or the accessories). If the pressure in the plug is too low (lower than the nominal pressure) while certain back pressure acts on the plug, forces develop that act on the plug and try to move it. The plug may move suddenly, which may lead to catastrophic consequences, including injuries. The immediate action to be taken is to start reducing the back pressure behind the plug and increase the pressure in the plug (Figure 6). We recommend using safety supports when back pressure is expected to build up behind the plug. The way of setting up the supports depends on the specific situation, in which the plug is used.



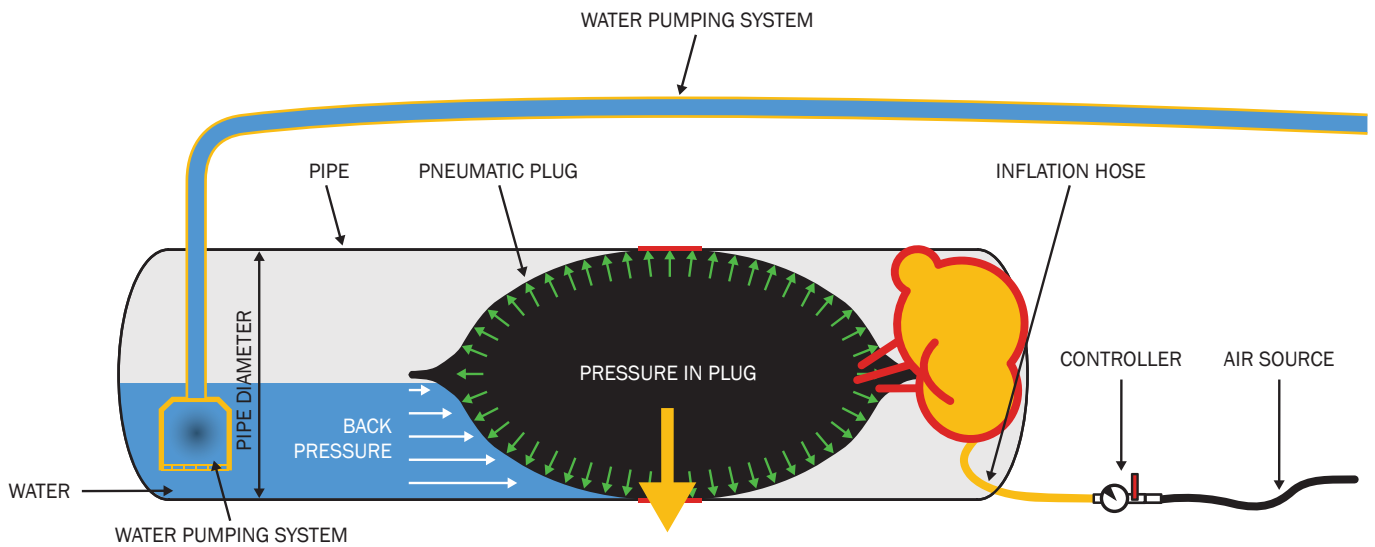

Figure 7

If the pressure in the plug is too low, it is highly likely the plug will move. Such a sudden movement causes the back pressure to drop; the plug may rupture instantly, which is accompanied by a release of a huge amount of air and a loud bang. Bursting of the plug may have catastrophic consequences: due to its abrupt deflation, a huge amount of air moves along the pipe creating a shock wave that propagates through the pipe in all directions, including the manholes. The plug is no longer suitable for use.

**Situation: the working pressure in the plug drops, the plug is damaged**

If the instructions are fully complied with, such a situation cannot occur; however, if it does, it is extremely dangerous and requires immediate action. It may occur if the plug leaks due to mechanical damage (damage or cuts caused during plug's insertion into the pipe).

If the plug is mechanically damaged (cuts), the product is highly likely to burst. Bursting is instantaneous, a huge amount of air is released with a loud bang, and the consequences can be catastrophic. The plug deflates instantly, a huge volume of air abruptly moves along the pipe, creating an air shock wave, which propagates through the pipe in all directions, including the manholes. Bursting of the plug may have catastrophic consequences and may result in injuries (Figure 7). The plug is no longer suitable for use.

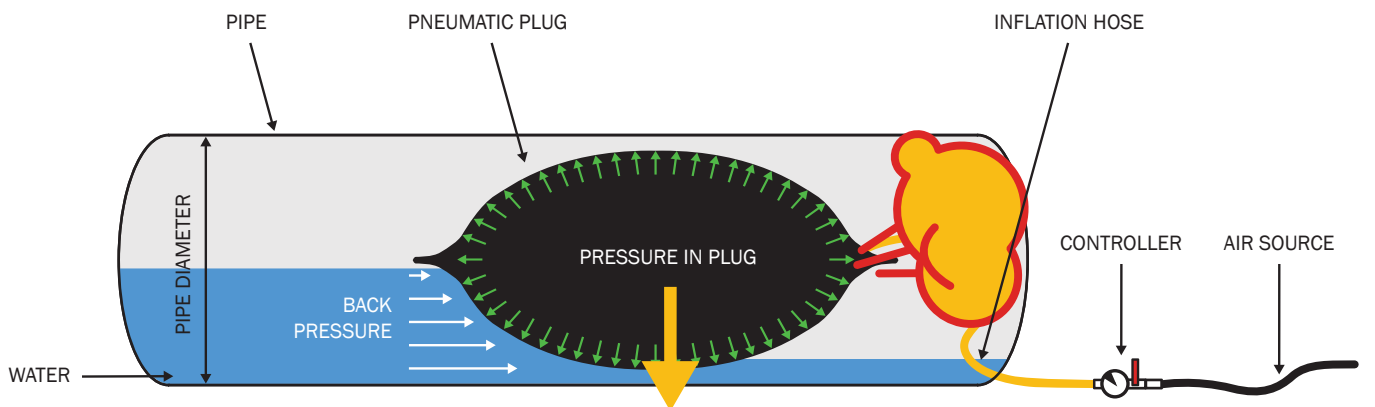

Figure 8

**Situation: the back pressure behind the plug generated by air**

The situation is slightly different where the back pressure is generated by air. One of the basic properties of air is compressibility. The pressure is evenly distributed over the entire surface. It is therefore of paramount importance to continuously monitor the back pressure behind the plug and keep it within the specified limits, as determined for a particular plug. We recommend using safety supports when back pressure is expected to build up behind the plug. The way of setting up the supports depends on the specific situation, in which the plug is used. If the instructions are fully complied with, pressure build-up cannot occur. However, if it does, it is extremely dangerous and requires immediate action. The pressure behind the plug must be reduced immediately. If this is not done, the back pressure will start to rise, which increases the total force acting on the plug. The plug may move or burst, which may have catastrophic consequences. Bursting is instantaneous, releasing a huge amount of air accompanied by a loud bang. The consequences of the rupture can be catastrophic and can cause injuries (Figure 8). The plug is no longer suitable for use.

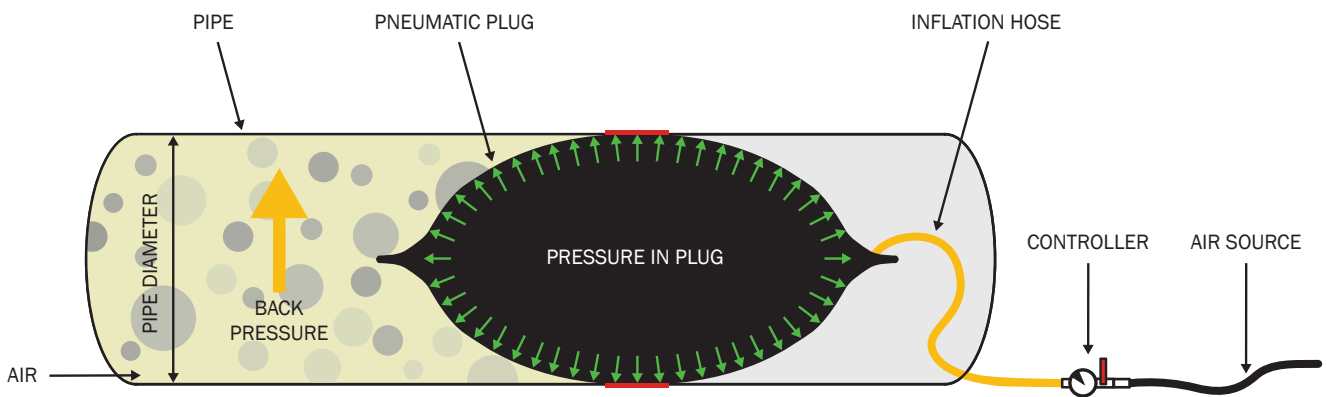

Figure 9

**Situation: plug insertion in the pipeline**

Before and after every use, inspect the plug from all sides for damage. If noticing any, do not use the plug. The main advantage of the pillow plug is that it can be inserted into the pipeline through a relatively small inlet. Unfold the plug on a flat surface. Fold the two longer sides towards the centre and insert the plug through the manhole into the pipeline. Care and attention must be taken when moving and inserting the plug into the pipeline to prevent any damage to the plug (mechanical damage, cuts). Once the plug is in inflation position, inflate it using the calibrated controller (Figure 9).

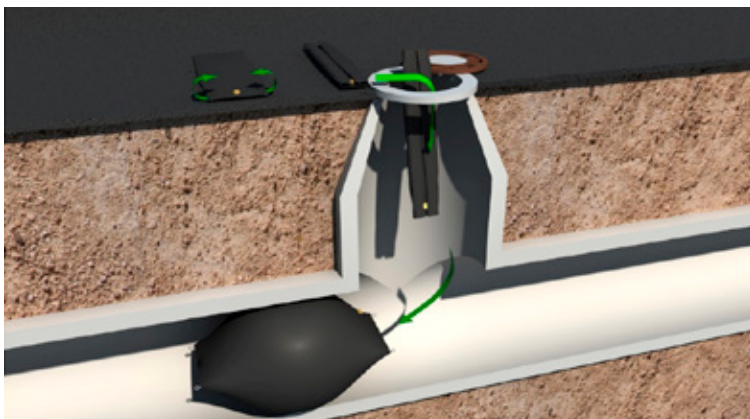

Figure 10

### Situation: positioning the plug during inflation

Make sure the plug is positioned in the pipe as centrally as possible to contribute to a more correct distribution of forces the plug has to resist during use. If the plug is not centrally positioned, it may happen that the bottom and the top of the plug are not inflated evenly, which can damage the plug (Figure 10). In Figure 11 you can see on the left side the plug inserted in the pipe. The illustration in the middle shows a correctly inflated plug. The plug on the right side is not inflated evenly. It is evident that the upper half of the plug is more stretched than the bottom one. Such a situation must be avoided as it can lead to the plug bursting.

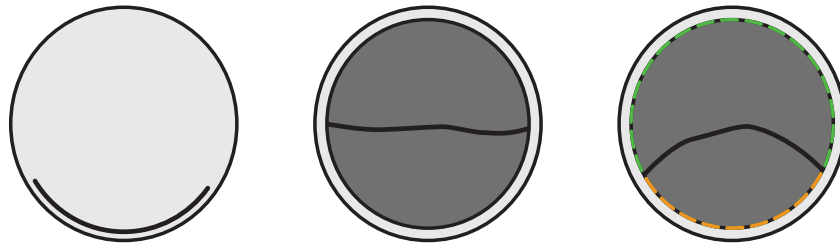

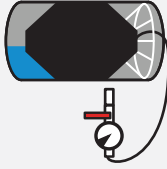
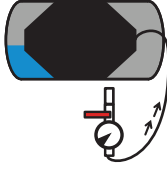
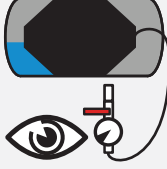
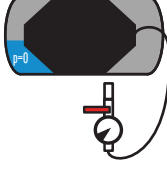
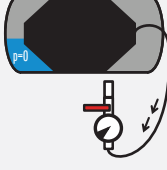



Figure 11

## 1.2. CONICAL PLUGS

### 1.2.1. STEPS FOR USING CONICAL PLUGS

	ILLUSTRATION	PROCEDURE	WARNING
1.		Measure the diameter of the pipe and choose the right pneumatic conical plug.	Check the technical data and back pressure tables to choose the right plug.
2.		Check and prepare at the site: air source, plug, calibrated controller, air hoses.	Prior to using the plug, thoroughly check the plug and the accessories. If the plug or the accessories are damaged, remove them from service and replace them.
3.		Clean the pipe in which the plug will be used.	Even the smallest sharp particles in the uncleaned pipe may damage the plug.
4.		Fold the two longer sides of the plug towards the centre of the plug.	When folding the plug in the pipe, take care not to damage the plug.

	ILLUSTRATION	PROCEDURE	WARNING
5.		<p>Insert the pneumatic plug in the pipe.</p>	<p>When inserting the plug, take care not to damage the plug. It should be placed horizontally.</p>
6.		<p>Set up the safety support for the plug. The way of setting-up depends on the specific situation, in which the plug is used.</p>	<p>Failure to use the support may cause injuries to people in the event of excessive back pressure. The metal components on the plug are not intended for fixing the plug or setting-up the safety supports.</p>
7.		<p>Inflate the plug until it reaches the maximum working pressure indicated on the plug.</p>	<p>Staying near the pressurized plug is forbidden. Do not exceed the maximum working pressure indicated on the plug.</p>
8.		<p>Check the pressure in the plug throughout the work.</p>	<p>Staying near the pressurized plug is forbidden. Do not exceed the maximum working pressure indicated on the plug.</p>
9.		<p>When you finish the work, release the back pressure.</p>	<p>If the plug is deflated prior to releasing the back pressure, it may move unexpectedly in direction of the back pressure action.</p>
10.		<p>Empty the plug.</p>	<p>Double-check for the back pressure just before the deflation. If the plug is still pressurized, follow Step 9.</p>
11.		<p>After use, clean and store the deflated plug and the accessories as instructed.</p>	<p>Follow the instructions for cleaning and storing the pneumatic plug.</p>
12.		<p>Thoroughly check the plug and the accessories.</p>	<p>Remove any damaged plug or the accessories from further use and replace them.</p>

### 1.2.2. SITUATIONS THAT MAY ARISE WHEN USING CONICAL PLUGS

Insert the right plug in the selected place in the pipe and connect it to the inflation hose, calibrated controller and the air source. The plug and the accessories should be inspected and proven faultless. Clean the pipe properly. Water in the pipe should flow freely, as shown in Figure 12.

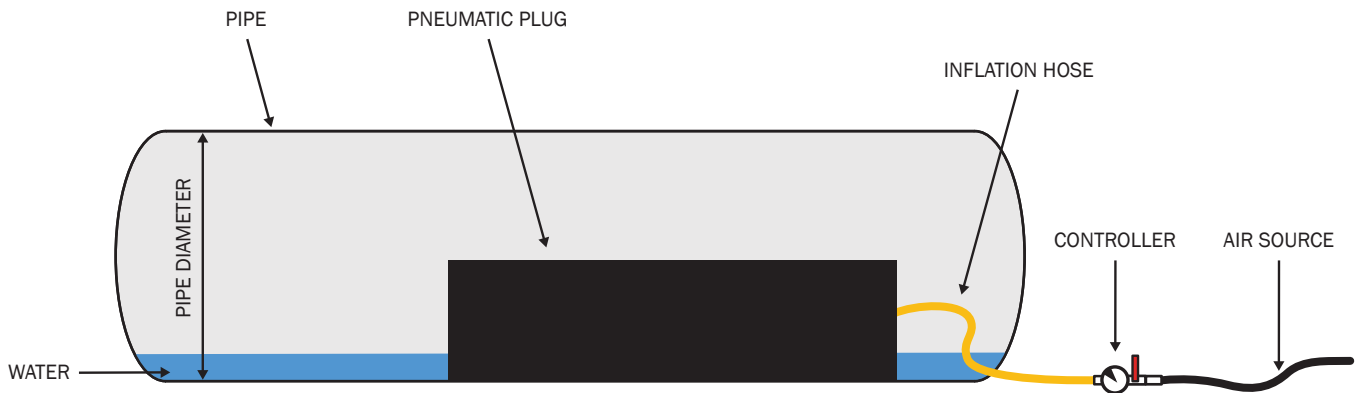

Figure 12

Once the plug is inserted in the pipe, inflate it until it reaches the prescribed working pressure. Use the calibrated controller. The plug is ready for use. Water starts to accumulate behind the plug while the back pressure behind the plug increases, resulting in a force that acts on the plug. The force is in proportion to the pressure and the pipe's surface behind the plug. Note that extremely high forces may develop (Figure 13).

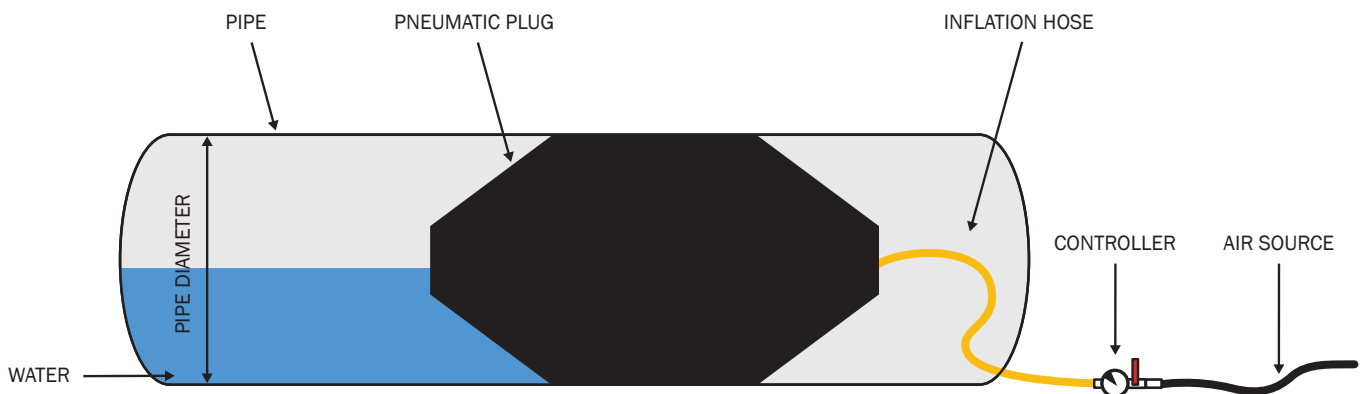

Figure 13

The resulting situation is presented in Figure 14. Using the calibrated controller, the plug is inflated to the prescribed working pressure in the cleaned pipe of a suitable diameter. The pressure in the plug distributes evenly over the entire surface of the plug. The contact surface between the plug and the pipe is marked in red. Coefficient of friction between contact surfaces of the plug and the pipe ensures the function of the plug. The back pressure values given in the table apply to dry metal pipes. If a pipe is wet or oily, coefficient of friction may be lower, which reduces the maximum back pressure the plug can resist. Water starts to accumulate behind the plug, creating the back pressure acting on the plug. The back pressure is distributed according to the principles of hydrostatic pressure, meaning that the pressure at the top of the liquid is lower than the one at the bottom of the liquid, irrespective of the shape. The maximum back pressure to be expected when using the plug is determined with the pipe's diameter and the working pressure in the plug; it must not be exceeded. For safety reasons, we therefore recommend the installation of the system behind the plug that maintains a constant water level and thus prevents an uncontrolled increase in back pressure (Figure 15). We recommend using safety supports when back pressure is expected to build up behind the plug.

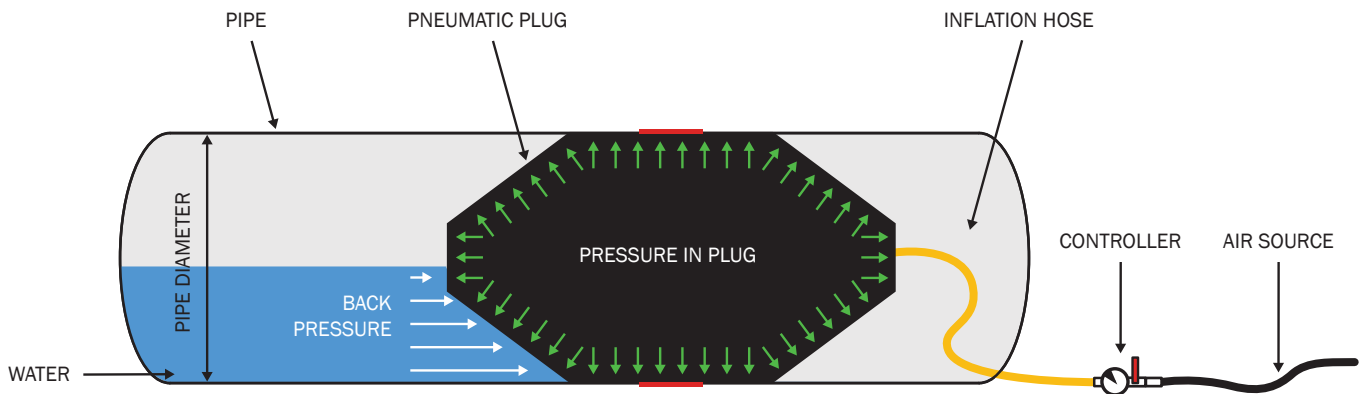

Figure 14

**Situation: the back pressure is higher than expected**

If the instructions are fully complied with, such a situation cannot occur; however, if it does, it is extremely dangerous and requires immediate action. Immediately reduce the pressure behind the plug by limiting or shutting off water inflow behind the plug and start pumping water immediately (e.g. with a submersible pump of appropriate rating). If not, the back pressure will begin to increase and, consequently, the total force acting on the plug will increase too. The plug may move or burst, which may have catastrophic consequences. We recommend using safety supports when back pressure is expected to build up behind the plug. The way of setting up the supports depends on the specific situation, in which the plug is used.

Failure to do so may result in a sudden, unexpected burst of the plug. Change is instantaneous with a huge amount of air released, accompanied by a loud bang. Bursting may have catastrophic consequence and may lead to injuries. The plug is no longer suitable for use.

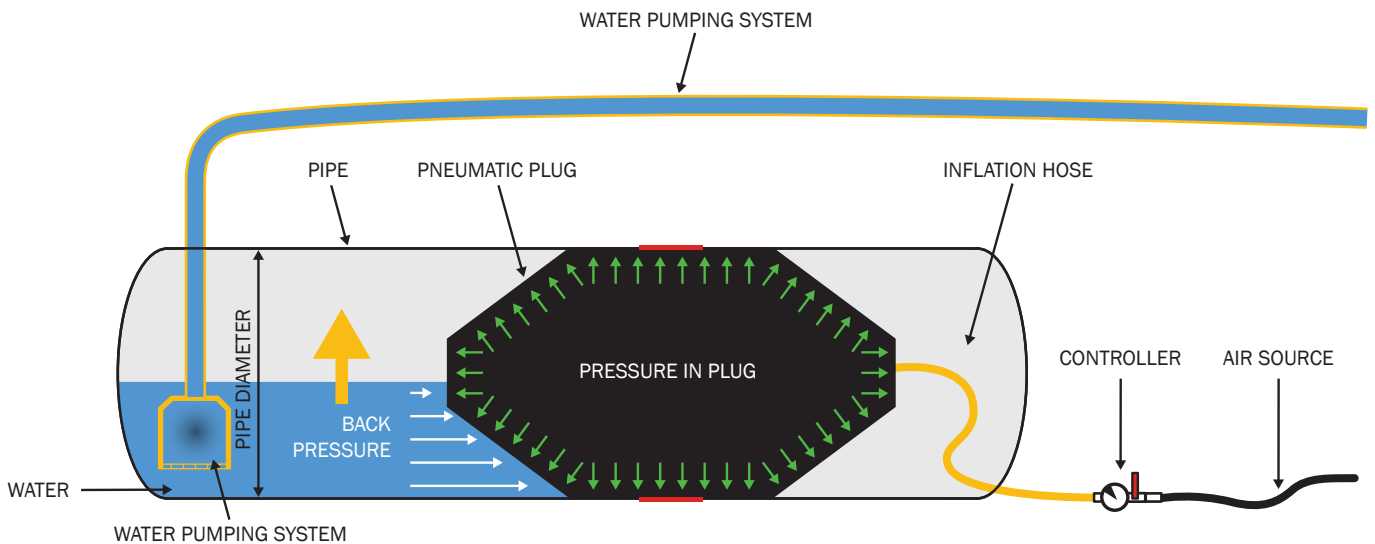

Figure 15

**Situation: the working pressure in the plug is higher than expected**

If the instructions are fully complied with, such a situation cannot occur; however, if it does, it is extremely dangerous and requires immediate action. If the working pressure is exceeded, the safety valve on the calibrated controller is activated to release the excessive pressure. The activated safety valve audibly alerts the user of exceeded working pressure. When the plug is inflated, the pressure in the plug begins to rise extremely slowly while the plug expands until it reaches the inner diameter of the pipe. The closer the plug is to the final diameter and shape of the pipe, the faster the pressure in the pipe increases, which is why the inflation procedure should be slowed down and pressure repeatedly checked (Figure 16).

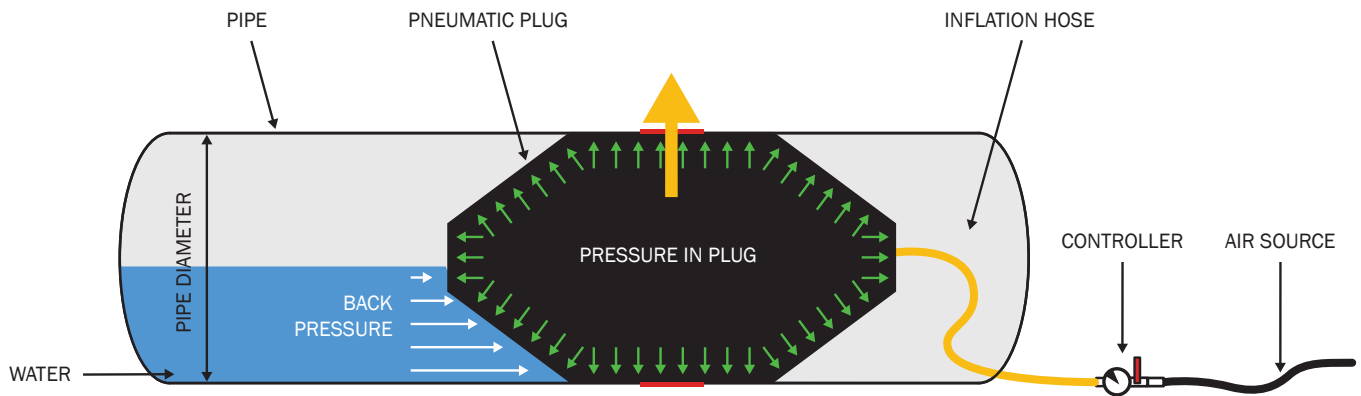

Figure 16

If the pressure change is too rapid (which can happen when the plug is being inflated without supervision), the safety valve fails to provide sufficient release of excessive pressure, which is why the pressure in the plug rises beyond the permitted value. Although the product is designed to have a built-in safety feature against bursting, the plug may rupture. The consequences of plug bursting can be catastrophic. If noticing a sudden rise in the working pressure (usually during inflation), stop the procedure immediately and make sure for the pressure in the plug to be safely reduced. Find out the cause of the pressure rising too quickly and fix the fault.

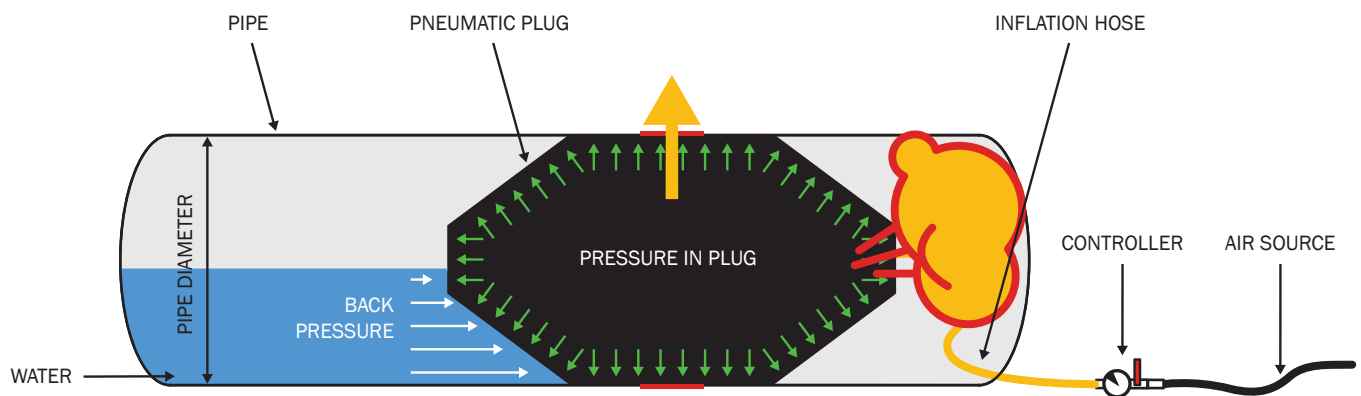

Figure 17

Failure to do so may result in sudden, unexpected bursting of the plug. Change is instantaneous with a huge amount of air released, accompanied by a loud bang. Bursting of the plug may have catastrophic consequence and may lead to injuries (Figure 17). The plug is no longer suitable for use.

**Situation: the working pressure in the plug is too low, the back pressure builds up behind the plug**

If the instructions are fully complied with, such a situation cannot occur; however, if it does, it is extremely dangerous and requires immediate action. It can occur if the pressure in the plug drops slowly (e.g. leaking of the plug or the accessories). If the pressure in the plug is too low (lower than the nominal pressure) while certain back pressure acts on the plug, forces develop that act on the plug and try to move it. The plug may move suddenly, which may lead to catastrophic consequences, including injuries. The immediate action to be taken is to start reducing the back pressure behind the plug and increase the pressure in the plug (Figure 18). We recommend using safety supports when back pressure is expected to build up behind the plug. The way of setting up the supports depends on the specific situation, in which the plug is used.



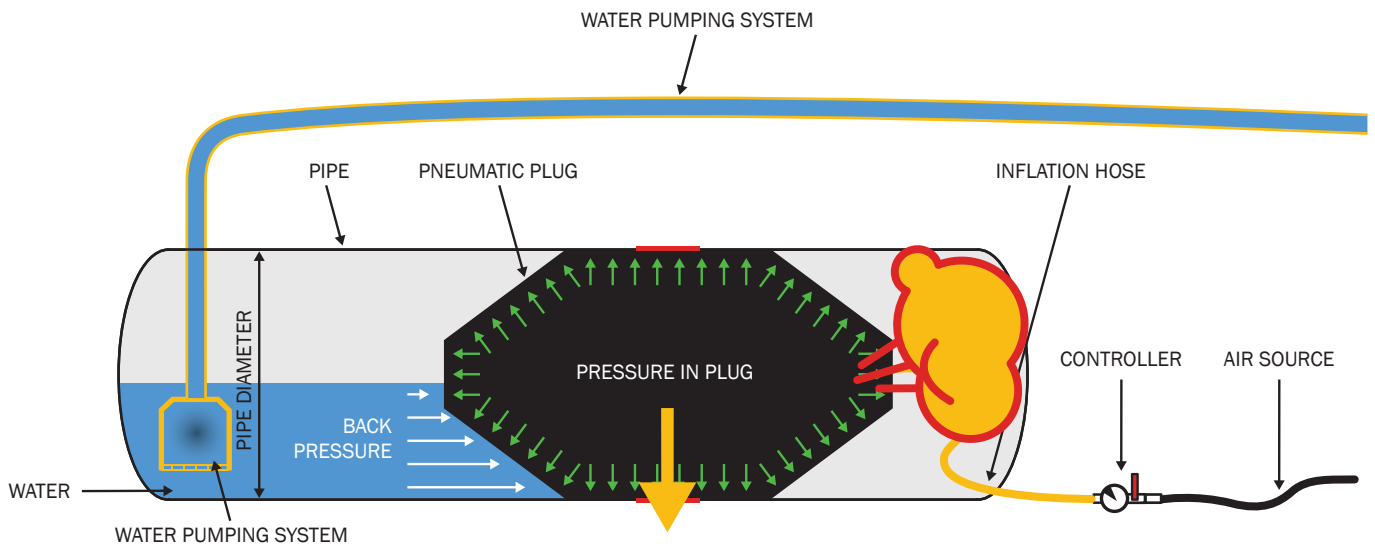

Figure 18

If the pressure in the plug is too low, it is highly likely the plug will move. Such a sudden movement causes the back pressure to drop; the plug may rupture instantly, which is accompanied by a release of a huge amount of air and a loud bang. Bursting of the plug may have catastrophic consequences: due to its abrupt deflation, a huge amount of air moves along the pipe creating a shock wave that propagates through the pipe in all directions, including the manholes. The plug is no longer suitable for use.

**Situation: the working pressure in the plug drops, the plug is damaged**

If the instructions are fully complied with, such a situation cannot occur; however, if it does, it is extremely dangerous and requires immediate action. It may occur if the plug leaks due to mechanical damage (damage or cuts caused during plug's insertion into the pipe).

If the plug is mechanically damaged (cuts), the product is highly likely to burst. Bursting is instantaneous, a huge amount of air is released with a loud bang, and the consequences can be catastrophic. The plug deflates instantly, a huge volume of air abruptly moves along the pipe, creating an air shock wave, which propagates through the pipe in all directions, including the manholes. Bursting of the plug may have catastrophic consequences and may result in injuries (Figure 19). The plug is no longer suitable for use.

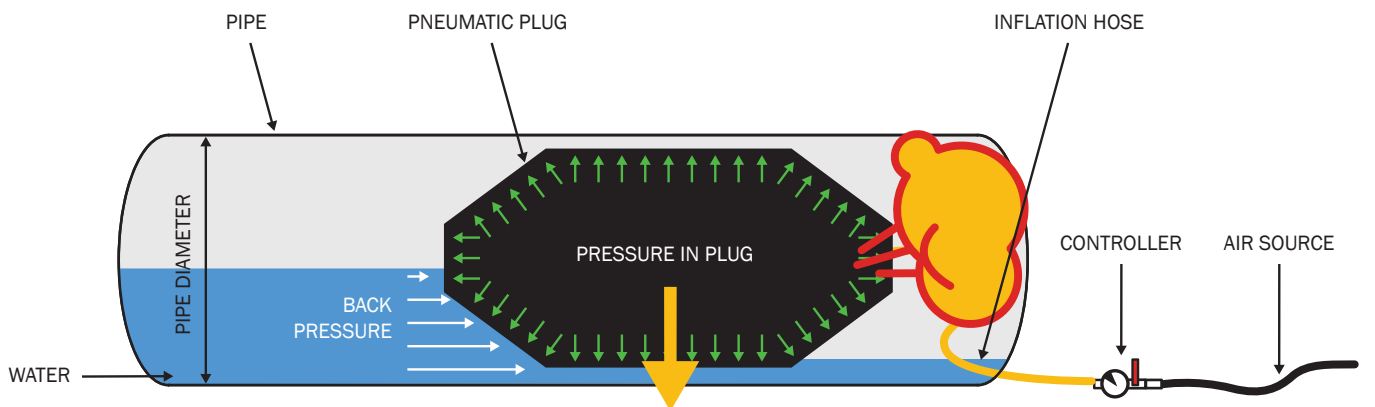

Figure 19

### Situation: the back pressure behind the plug generated by air

The situation is slightly different where the back pressure is generated by air. One of the basic properties of air is compressibility. The pressure is evenly distributed over the entire surface. It is therefore of paramount importance to continuously monitor the back pressure behind the plug and keep it within the specified limits, as determined for a particular plug. We recommend using safety supports when back pressure is expected to build up behind the plug. The way of setting up the supports depends on the specific situation, in which the plug is used. If the instructions are fully complied with, pressure build-up cannot occur. However, if it does, it is extremely dangerous and requires immediate action. The pressure behind the plug must be reduced immediately. If this is not done, the back pressure will start to rise, which increases the total force acting on the plug. The plug may move or burst, which may have catastrophic consequences. Bursting is instantaneous, releasing a huge amount of air accompanied by a loud bang. The consequences of the rupture can be catastrophic and can cause injuries (Figure 20). The plug is no longer suitable for use.

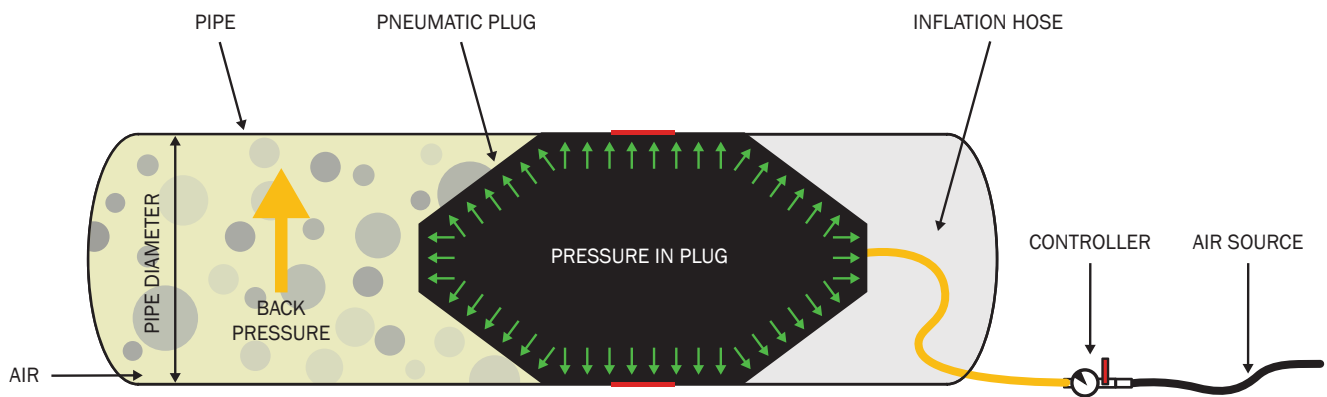

Figure 20

### Situation: plug insertion in the pipeline

Before and after every use, inspect the plug from all sides for damage. If noticing any, do not use the plug. The main advantage of the conical plug is that it can be inserted into the pipeline through a relatively small inlet. Unfold the plug on a flat surface. Fold the two longer sides towards the centre and insert the plug through the manhole into the pipeline. Care and attention must be taken when moving and inserting the plug into the pipeline to prevent any damage to the plug (mechanical damage, cuts). Once the plug is in inflation position, inflate it using the calibrated controller.

### Situation: positioning the plug during inflation

Make sure the plug is positioned in the pipe as centrally as possible to contribute to a more correct distribution of forces the plug has to resist during use. If the plug is not centrally positioned, it may happen that the bottom and the top of the plug are not inflated evenly, which can damage the plug. The plug must be inserted deep enough into the pipe.

### 1.3. HOUSE TEST KIT

#### AIR LEAK TEST (PROCEDURE "L")

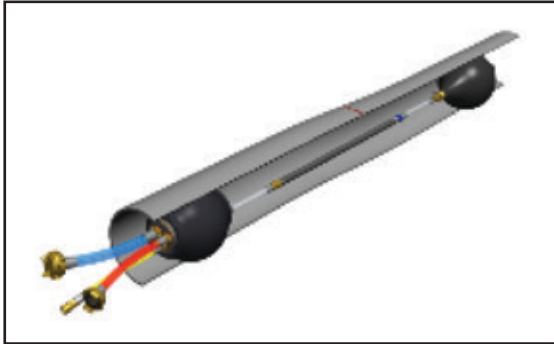

Figure 21: Air leak test (procedure "L")



**STEP 1:**

First, properly clean the drain or part of the drain you wish to test.

**STEP 2:**

Fix the spring inflation hose on the blocking plug and the appropriate number of push rods on the hose.

**STEP 3:**

Fix the safety rope on the blocking plug.



**STEP 4:**

Install a corresponding number of push rods on the spring inflation hose.

**ATTENTION: Manually tighten the blue part of the coupling on push rods for extra protection against opening.**

**STEP 5:**

Wrap the safety rope around the push rods.

**STEP 6:**

Insert the blocking plug with the push rods into the pipe and push it until it reaches the desired position.

**STEP 7:**

Fit a second spring inflation hose on the last push rod.

**STEP 8:**

Connect the bypass plug with a second spring inflation hose and the other end of the safety rope, via the carabiner, with the bypass plug.



**STEP 9:**

Insert the bypass plug into the pipe.

**ATTENTION: Turn the bypass plug so that the blue hose faces the bottom of the pipe.**

**STEP 10:**

Fit the controller with the safety valve on the yellow inflation hose of the bypass plug and fill both plugs to the prescribed pressure. They are inflated simultaneously.

**STEP 11:**

Place the cover on the red hose of the bypass plug.

**STEP 12:**

Install the safety element for air leak test on the blue measuring hose of the bypass plug. Install the air supply adapter on the middle outlet of the safety element. Install the corresponding measuring device on the free outlet.



Figure 22: Connection for testing with air

If using a hand-held digital pressure gauge, connect it to the free output via the digital pressure gauge adapter, as shown in Figure 23.



Figure 23: Air leak test with a hand-held digital pressure gauge

**STEP 13:**

Via the adapter, fill the hose with air. If using a compressor as the air source, make sure air is oil-free. When the prescribed pressure is reached, close the valve on the safety test element and begin to measure. The test pressure, test time and release criteria are defined in the EN 1610 standard.

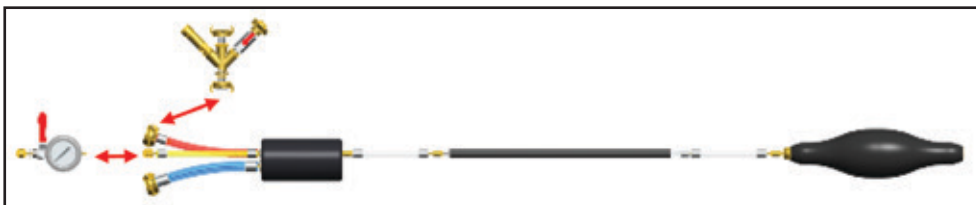

Figure 24: Connection of SAVA house connection air leak test kit ("L" procedure)

**STEP 14:**

When the test is finished, first open the ball valve on the air leak test safety element to release air from both plugs. Remove the bypass plug and, using the push rods and safety rope, pull the blocking plug from the pipe.

**ATTENTION: Make sure that both plugs are deflated before removal.**

**STEP 15:**

Clean, inspect and dry the equipment. Store the push rods in the protective tube provided.

**ATTENTION: Be careful with the push rods if temperatures are low. Warm them up to the room temperature before use. Store the cleaned equipment, with the exception of push rods, in the carrying case.**

## WATER LEAK TEST (PROCEDURE "W")

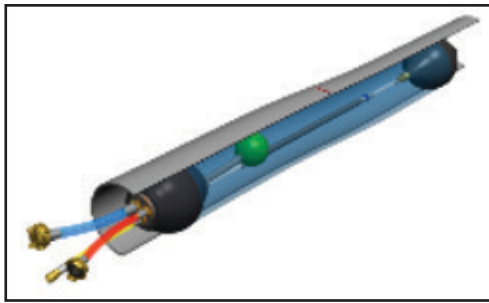

Figure 25: Testing with water (Procedure "W")

### STEP 1:

First, properly clean the drain or part of the drain you wish to test.

### STEP 2:

Fit the venting floater on the rear end of the bypass plug.

**ATTENTION: The floater must be screwed all the way into the plug and turned so that its opening faces upwards.**

### STEP 3:

Place the spring inflation hose on the blocking plug and the corresponding number of push rods on the hose (No. 6).

### STEP 4:

Place the safety rope on the blocking plug

### STEP 5:

Place the corresponding number of push rods on the spring inflation hose.

**ATTENTION: Manually tighten the blue part of the coupling on push rods for extra protection against opening.**

### STEP 6:

Wrap the safety rope around the push rods.

### STEP 7:

Insert the blocking plug with push rods into the pipe and push it until it reaches the desired position.

### STEP 8:

Place a second spring inflation hose to the last push rod.

### STEP 9:

Connect the bypass plug with a second spring inflation hose and the other end of the safety rope, via the carabiner, with the bypass plug.

### STEP 10:

Insert the bypass plug into the pipe.

**ATTENTION: Turn the bypass plug so that the blue hose faces the bottom of the pipe.**

### STEP 11:

Install the controller with the safety valve on the yellow inflation hose of the bypass plug and fill both plugs to the prescribed pressure. They are inflated simultaneously.

**STEP 12:**

Connect the transparent measuring hose for water leak test to the red hose of the bypass plug. If you wish to perform parallel measurement, install a T-piece for parallel measurement between the transparent measuring hose and the bypass plug. Place the transparent measuring hose vertically to enable measurement.



Figure 26: Connection for testing with water

**STEP 13:**

Install the ball valve with a gate on the blue hose of the bypass plug and connect water supply to the ball valve.

**STEP 14:**

Open the ball valve to fill the pipe you test with water. The test pressure, test time and release criteria are defined in the EN 1610 standard.

**STEP 15:**

When the test with water is finished, open the ball valve and let the water flow from the pipe. Remove the transparent measuring hose and release air from both plugs. Remove the bypass plug and pull the blocking plug from the pipe using push rods and safety rope.

**ATTENTION: Make sure that both plugs are deflated before removal.**

**STEP 16:**

Clean, inspect and dry the equipment. Store the push rods in the protective tube provided.

**ATTENTION: Be careful with the push rods if temperatures are low. Warm them up to the room temperature before use.**

Store the cleaned equipment, with the exception of push rods, in the carrying case.

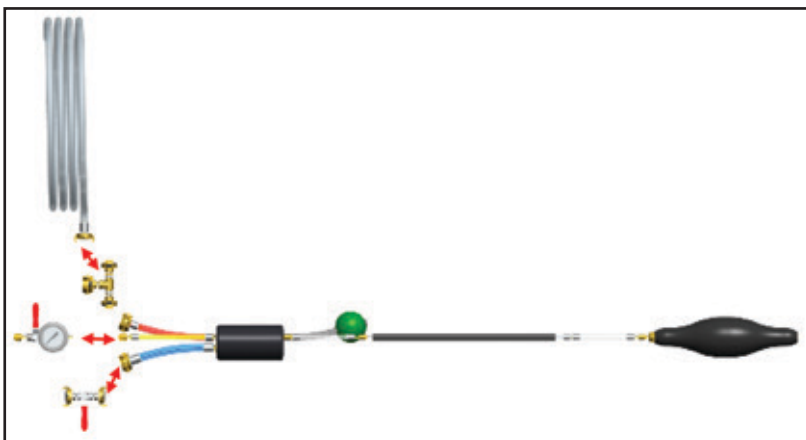

Figure 27

## 1.4. TESTING WITH AIR

Testing equipment:

- SAVA bypass pneumatic plug
- SAVA blocking pneumatic plug
- Air test adapter
- Bypass 1": R1 (60449) or
- Bypass 2": R2 (60450) or
- Bypass 4": R4 (60443)
- and-held digital pressure gauge (582732)

### STEP 1:

Thoroughly clean the area of the pipeline where the plugs will be inserted.

### STEP 2:

Restrict the pipeline leak test area on the far side with the blocking pneumatic plug. Seal all lateral lines.

### STEP 3:

Install the air test adapter onto the bypass tube of the bypass pneumatic plug. Connect the blue coupling to the air hose for the test area. Connect the hand-held digital pressure gauge to the red coupling.

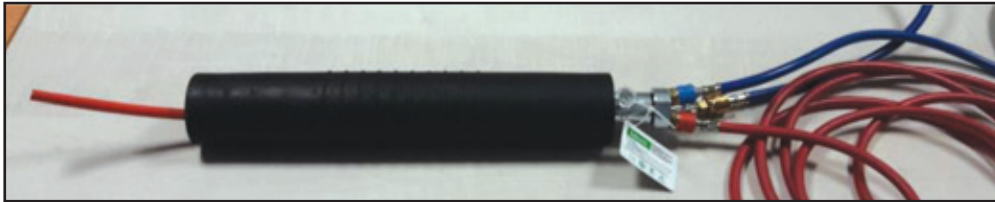

Figure 28

### STEP 4:

Insert the bypass pneumatic plug into the pipe on the measuring side of the pipeline leak test area.

### STEP 5:

Carry out air leak test according to the EN 1610 standard.

### STEP 6:

After the test, empty the pipeline test area. Remove the bypass plug and SAVA blocking pneumatic plugs.

**ATTENTION: Make sure that the plugs are deflated before removal.**

### STEP 7:

Clean, inspect and dry the equipment and store it properly.

## VERTICAL MANHOLE/GULLY

Testing equipment:

- Gully test plugs: Plugsy VJ
- Blocking pneumatic plugs
- Air test adapter
- Bypass 2": R2 (60450) or
- Hand-held digital pressure gauge (582732)

### STEP 1:

Thoroughly clean the area of the gully and the pipeline, where the plugs will be inserted.

### STEP 2:

Restrict the pipeline leak test area on the far side with the blocking pneumatic plug. Seal all lateral lines.



**STEP 3:**

Install the air leak test adapter onto the bypass tube on the upper side of the Plugsy VJ test plug. Connect the blue coupling to the air hose for the test area. Connect the hand-held digital pressure gauge to the red coupling.

**STEP 4:**

Insert the Plugsy VJ test plug into the gully.

**STEP 5:**

Carry out air leak test according to the EN 1610 standard.

**STEP 6:**

After the test, empty the pipeline test area. Remove the Plugsy VJ test plug.

**ATTENTION: Make sure that the plugs are deflated before removal.**

**STEP 7:**

Clean, inspect and dry the equipment and store it properly.

## 1.4. TESTING WITH AIR

Testing equipment:

- Two bypass pneumatic plugs
  - Water leak test adapter
  - Bypass 1": Storz D (60407) or
  - Bypass 2": Storz C (60412) or
  - Bypass 4": Storz A (60438)
- Venting floater
  - Bypass 1": (60446) or
  - Bypass 2": (60448) or
  - Bypass 4": (60439)
- Venting adapter
  - Bypass 1": Storz D (60380) or
  - Bypass 2": Storz C (60388) or
  - Bypass 4": Storz A (60428)

**STEP 1:**

Thoroughly clean the area of the pipeline where the plugs will be inserted.

**STEP 2:**

Install the venting adapter onto the bypass tube next to the inflation connector of the bypass plug. Install the venting floater on the other side of the bypass tube.



Figure 29

**STEP 3:**

Restrict the pipeline leak test area on the far side with a bypass plug for venting. Seal all lateral lines.

**STEP 4:**

Install the water test adapter on the bypass tube of the bypass pneumatic plug for water leak test.



Figure 30

**STEP 5:**

Insert the bypass pneumatic plug for measuring into the pipe on the measuring side of the pipeline leak test area.

**STEP 6:**

Carry out water leak test according to the EN 1610 standard.

**ATTENTION: Vent the test area properly.**

**STEP 7:**

After the test, empty the pipeline test area. Remove SAVA bypass plugs and blocking pneumatic plugs.

**ATTENTION: Make sure that the plugs are deflated before removal.**

**STEP 8:**

Clean, inspect and dry the equipment and store it properly.

**VERTICAL MANHOLE/GULLY**

Testing equipment:

- Gully test plugs: Plugsy VJ
- Blocking pneumatic plugs
- Water test adapter
- Bypass 2": Storz C (60412)
- Hand-held digital pressure gauge (582732)

**STEP 1:**

Thoroughly clean the area of the gully and the pipeline, where the plugs will be inserted.

**STEP 2:**

Restrict the pipeline leak test area on the far side with a blocking pneumatic plug. Seal all lateral lines.

**STEP 3:**

Install the water test adapter onto the bypass tube on the upper side of the Plugsy VJ test plug.

**STEP 4:**

Insert the Plugsy VJ test plug into the gully.

**STEP 5:**

Carry out air leak test according to the EN 1610 standard.

**ATTENTION: Make sure that the test area is properly vented.**

**STEP 6:**

After the test, empty the gully test area. Remove the Plugsy VJ test plug.

**ATTENTION: Make sure that the plugs are deflated before removal.**

**STEP 7:**

Clean, inspect and dry the equipment and store it properly.

## ATTACHMENT 6: CONTAINS THE TABLES OF CONTROLLERS AND INFLATION HOSES.

Attachment 6 contains the tables of controllers and inflation hoses.



When working with pneumatic plugs, we recommend that you use original accessories, which can be obtained from the manufacturer.

### 1.1. TABLE OF CONTROLLERS

Below is a table of controllers that can be used with pneumatic plugs. The table is for information purposes only. Please contact your sales agent or the manufacturer for further information.

Table 1:

PLUG FAMILY	WORKING PRESSURE OF THE PLUG	CONTROLLER	CONTROLLER CODE	INLET CONNECTION	OUTLET CONNECTION
PLUGY Z PLUGSY Z	2.5 bar	Hand pump with pressure gauge 0–6 bar	60010	/	Hand pump connection
PLUGY DC	2.5 bar	Hand pump with pressure gauge 0–6 bar	60010	/	Hand pump connection
PLUGY G PLUGSY GM	3.0 bar 2.5 bar 2.0 bar 1.5 bar	Single fitting controller 3.0 bar Single fitting controller 2.5 bar Single fitting controller 2.0 bar Single fitting controller 1.5 bar	537048 60310 565643 74609	Safety coupling TYPE 26	Connector TYPE 26
PLUGY PLUGSY	2.5 bar 2.0 bar 1.5 bar 1.0 bar	Single fitting controller 2.5 bar Single fitting controller 2.0 bar Single fitting controller 1.5 bar Single fitting controller 1.0 bar	60310 565643 74609 74653	Safety coupling TYPE 26	Connector TYPE 26
PLUGY EI PLUGSY EI	1.5 bar 1.3 bar 0.9 bar 0.8 bar 0.6 bar	Single fitting controller 1.5 bar Single fitting controller 1.0 bar	74609 504061	Safety coupling TYPE 26	Connector TYPE 26 2× GEKA coupling
PLUGY HPF PLUGSY HPF	3.0 bar 2.5 bar 1.5 bar 1.0 bar	Single fitting controller 3.0 bar Single fitting controller 2.5 bar Single fitting controller 1.5 bar Single fitting controller 1.0 bar	547645 547646 547647 547650	Safety coupling TYPE 27 Safety coupling TYPE 57	Connector TYPE 27 Connector TYPE 57
PILLOW PLUGY PILLOW PLUGSY	1.0 bar 0.9 bar 0.8 bar 0.6 bar 0.5 bar 0.4 bar 0.3 bar	Double fitting controller 1.0 bar	504061	Safety coupling TYPE 26	2× GEKA coupling
PLUGSY VP	2.5 bar 2.0 bar 1.5 bar 1.0 bar	Single fitting controller 2.5 bar Single fitting controller 2.0 bar Single fitting controller 1.5 bar Single fitting controller 1.0 bar	60310 565643 74609 74653	Safety coupling TYPE 26	Connector TYPE 26
PLUGSY VJ	1.5 bar 1.0 bar	Single fitting controller 1.5 bar Single fitting controller 1.0 bar	74653 508270	Safety coupling TYPE 26	Connector TYPE 26
PLUGY HP 6 bar	6.0 bar	Single fitting controller 6.0 bar	531542	Safety coupling TYPE 26	Connector TYPE 26
PLUGY HP 12 bar	12.0 bar	Single fitting controller 12.0 bar	531544	Safety coupling TYPE 26	Connector TYPE 26
PLUGY HP 30 bar	30.0 bar	Single fitting controller 30.0 bar	282184	Safety coupling TYPE 26	Connector TYPE 26
CONE PLUGY CONE PLUGSY PLUGSY B-VP	1.0 bar	Single fitting controller 1.0 bar	578031	GEKA coupling	GEKA coupling
PLUGY NBR	2.5 bar 1.5 bar	Single fitting controller 2.5 bar Single fitting controller 1.5 bar	583712 583711	Safety coupling TYPE 26 INOX	Connector TYPE 26 INOX

## 1.2. TABLE OF INFLATION HOSES

Below is a table of inflation hoses that can be used with pneumatic plugs. The table is for information purposes only. Please contact your sales agent or the manufacturer for further information.

Table 2:

PLUG FAMILY	WORKING PRESSURE OF THE PLUG	HOSE CODE	HOSE LENGTH	HOSE COLOUR	INLET CONNECTION	OUTLET CONNECTION
PLUGY Z PLUGSY Z	2.5 bar	78904 78905	2 m 5 m	transparent	/	Hand pump connection
PLUGY DC	2.5 bar	60010	2 m 5 m	transparent	/	Hand pump connection
PLUGY G PLUGSY GM	3.0 bar 2.5 bar 2.0 bar 1.5 bar	74268 71248 76686	10 m	red blue yellow	Coupling TYPE 26	Connector TYPE 26
PLUGY PLUGSY	2.5 bar 2.0 bar 1.5 bar 1.0 bar	74268 71248 76686	10 m	red blue yellow	Coupling TYPE 26	Connector TYPE 26
PLUGY EI PLUGSY EI	1.5 bar 1.3 bar 0.9 bar 0.8 bar 0.6 bar	74268 71248 76686 519817	10 m	red blue yellow	Coupling TYPE 26 GEKA coupling	Connector TYPE 26 GEKA coupling
PLUGY HPF PLUGSY HPF	3.0 bar 2.5 bar 1.5 bar 1.0 bar	547714 547715	10 m	blue	Coupling TYPE 27 Coupling TYPE 57	Connector TYPE 27 Connector TYPE 57
PILLOW PLUGY PILLOW PLUGSY	1.0 bar 0.9 bar 0.8 bar 0.6 bar 0.5 bar 0.4 bar 0.3 bar	519817	10 m	yellow	GEKA coupling	GEKA coupling
PLUGSY VP	2.5 bar 2.0 bar 1.5 bar 1.0 bar	74268 71248 76686	10 m	red blue yellow	Coupling TYPE 26	Connector TYPE 26
PLUGSY VJ	1.5 bar 1.0 bar	74268 71248 76686	10 m	red blue yellow	Coupling TYPE 26	Connector TYPE 26
PLUGY HP 6 bar	6.0 bar	74268 71248 76686	10 m	red blue yellow	Coupling TYPE 26	Connector TYPE 26
PLUGY HP 12 bar	12.0 bar	74268 71248 76686	10 m	red blue yellow	Coupling TYPE 26	Connector TYPE 26
PLUGY HP 30 bar	30.0 bar	74268 71248 76686	10 m	red blue yellow	Coupling TYPE 26	Connector TYPE 26
CONE PLUGY CONE PLUGSY PLUGSY B-VP	1.0 bar	519817	10 m	yellow	GEKA coupling	GEKA coupling
PLUGY NBR	2.5 bar 1.5 bar	583709	10 m	black	Coupling TYPE 26 INOX	Connector TYPE 26 INOX

Trelleborg is a leading global provider of solutions and engineered products made from polymer materials that provide sealing, damping and protection at critical points in demanding environments. Its innovative solutions sustainably improve business performance of customers.



[www.trelleborgslovenija.com](http://www.trelleborgslovenija.com)  
[www.trelleborg.com](http://www.trelleborg.com)



Trelleborg Slovenija d.o.o.  
Škofjeloška cesta 6, 4000 Kranj, Slovenia

T: +386 (0)4 206 6388  
E: [tis.kra.info.eko@trelleborg.com](mailto:tis.kra.info.eko@trelleborg.com)  
F: +386 (0)4 206 6390