



Conveyor Belts

HIGH-QUALITY CONVEYOR BELTS, MANUFACTURED IN ACCORDANCE WITH THE REQUIREMENTS OF INTERNATIONAL STANDARDS



Contents

SMOOTH SURFACE CONVEYOR BELTS.....	4	SPECIAL SURFACE BELTS	19
ANTI-ABRASIVE CONVEYOR BELTS	5	L-TYPE CONVEYOR BELTS	20
CLEAN COVER CONVEYOR BELTS.....	6	NOPPEN CONVEYOR BELTS	21
TEMPERATURE-RESISTANT CONVEYOR BELTS	7	SUPERGRIP, FINEGRIP AND MICROGRIP CONVEYOR BELTS.....	22
FIRE AND FLAME RESISTANT CONVEYOR BELTS.....	8	SPECIAL CONSTRUCTION BELTS	23
OIL AND GREASE RESISTANT CONVEYOR BELTS.....	9	SLIDING CONVEYOR BELTS.....	24
FOOD-GRADE (FDA) CONVEYOR BELTS	10	ELEVATOR CONVEYOR BELTS	24
PAH-FREE CONVEYOR BELTS.....	11	PIPETYPE CONVEYOR BELTS	25
CHEVRON BELTS	12	REINFORCED CONVEYOR BELTS	26
CHEVRON CONVEYOR BELTS.....	13	CARRYFLEX CONVEYOR BELTS.....	27
CHEVRON CONVEYOR BELTS WITH A- AND AH-TYPE PROFILES.....	15	CROSSSTABLE CONVEYOR BELTS.....	27
CHEVRON CONVEYOR BELTS AF-TYPE.....	16	TECHNICAL RUBBER SHEETS.....	28
CHEVRON CONVEYOR BELTS WITH F-TYPE PROFILES	17	FINDING SOLUTIONS FOR EVERY NEED.....	33
DESIGN YOUR UNIQUE CHEVRON	18	TRELLEBORG SLOVENIJA'S - VISION AND MISSION	34



Since 1948, our plant in Kranj, Slovenia, has been manufacturing high-tech conveyor belts and technical rubber sheets for distribution across various industries worldwide. We continuously refine these exceptional products are continuously refined, drawing upon the knowledge and expertise of our skilled engineers. Our comprehensive production range includes smooth conveyor belts in various rubber qualities and constructions, unique customized conveyor belts, as well as a wide variety of chevron conveyor belts and technical

rubber sheets. Our products are renowned for their exceptional safety features and extended lifespan. Strict standards are consistently applied at all stages of production.

Our Central Laboratory supervises the meticulous quality control of rubber compounds developed in-house to ensure compliance with ISO 9001, ISO 14001, and OHSAS 18001 standards. Our expert team is happy to help customers choose the most suitable conveyor belt with expert advice and recommendations.





Smooth Surface Conveyor Belts

ANTI-ABRASIVE CONVEYOR BELTS

Our anti-abrasive conveyor belts are carefully designed to excel in all types of material handling operations. Owing to durable carcass construction and superior cover quality, these belts are renowned for their reliability and extended lifespan in various industrial applications. They are highly effective in conveying a wide range of materials, especially those the fine, sharp-edged, or highly abrasive ones in particular.



Designation	Elastomer	Hardness ± 5 (Sh °A)	Abrasion ± 20 (mm ³)
Y	SBR	63	110
X	NR	65	100
W	BR/NR	60	70
WL SUPRA	BR/NR	64	40

Anti-abrasive conveyor belts are suitable for use in a wide range of applications across various industries. They are commonly used in the sand, gravel, and stone industries, as well as in cement plants and concrete plants. They are also suitable for use in heating and power stations, garbage incineration plants, road construction machinery, and the recycling and compost industries. These versatile belts prove to be effective in conveying slag, REA-gypsum, broken glass, silica sand, and silica sand-containing materials. Additionally, they are well suited for inclined conveyors transporting slippery materials, clay and argil. Their adaptability and versatility make them essential in diverse sectors.

Our conveyor belt range offers widths ranging **from 100 to 200 mm (with molded edges) and 100 mm to 2100 mm (with cut edges)**.

We provide a broad range of belt constructions of different tensile strengths, **from 125 N/mm to 3150 N/mm**,

to enable our customers to choose the optimal design for their applications and to ensure reliable and efficient performance under a wide range of operating conditions.

Our anti-abrasive conveyor belts have a multiply **EP carcass (warp polyester + weft polyamide)**, **EE carcass (wrap polyester + weft polyester)** or **EPP (warp polyester + warp polyamide + weft polyamide)**, a special rubber skimmed layer for superior fabric adhesion, and a highly abrasion-resistant cover. Covers of special qualities are also available on request.

Different belt cleaning systems can be used, including rubber, polyurethane, metal, and brush (rotation) cleaners. The Anti-Abarasive belts can operate within a wide ambient **range from -40 °C to +80 °C**. The anti-sticking characteristics of the belts are maintained throughout the cover thickness allowing for reduced pressing force from scrapers, thereby extending the belt's service time.

CLEAN COVER CONVEYOR BELTS

When transporting bulk material, one major issue can often arise: material sticking to the surface of the conveyor belt. A significant amount of the material accumulated on the underside of the belt disrupts smooth operation. The use of scraping devices can help clean the belt, however, that does not always guarantee fault-free operation. To address this challenge, our engineers have developed a new special rubber compound that minimizes material sticking to the belt's surface.

The **Clean-Cover** belts exhibit excellent anti-sticking characteristics, making it possible to reduce the pressing force of scrapers, thereby significantly extending the service life of the conveyor system. The CleanCover belts are offered in various constructions and rubber qualities, different tensile strengths of fabric and number of carcass plies, and in various thicknesses and types of covers such as **highly abrasion-resistant (CC-type), extremely abrasion-resistant (CC WLH)**.



Different belt cleaning systems can be used, including rubber, polyurethane, metal, and brush (rotation) cleaners. The CleanCover belts can operate within a wide ambient temperature range from **-40 °C to +80 °C**. The anti-sticking characteristics of the belts are maintained throughout the cover thickness allowing for reduced pressing force from scrapers, thereby extending the belt's service time.

The CleanCover belts **can be spliced in cold and hot splicing procedures, or using mechanical fasteners**, which provides flexibility in installation methods. Furthermore, we offer special types of CleanCover belts, such as sliding conveyor belts, Ripcheck belts, Noppen belts, and others upon request. These belts are suitable for conveying various materials, including the sticky ones like clay, sand, gravel, tailing, mud, REA gypsum, cement, titanium dioxide, and more.

TEMPERATURE-RESISTANT CONVEYOR BELTS

To reduce the risk of conveyor belt damage due to conveying hot materials, our engineers have designed four distinct belt types tailored to different temperature conditions.

Our belts are engineered to operate flawlessly even in **extreme conditions, including freezing environments as low as $-40\text{ }^{\circ}\text{C}$** . They are namely able to withstand extremely low temperatures without affecting the properties of different rubber qualities.

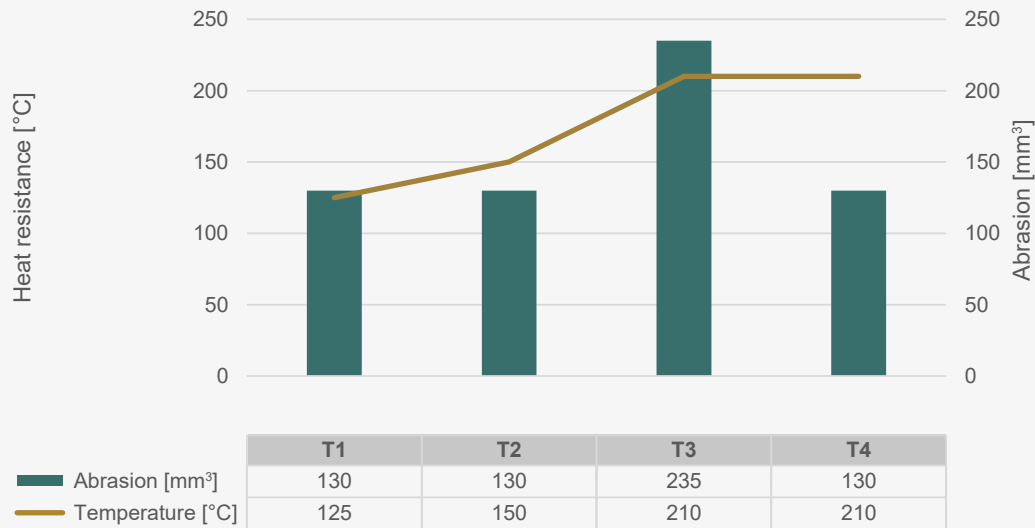

The temperature resistance of our conveyor belts depends on factors such as ambient temperature, grain size, and contact duration. Short-term peaks in material temperature can reach **up to $400\text{ }^{\circ}\text{C}$** . For more specific information, please reach out to us.

Our heat-resistant conveyor belts find application in various industries, including cement plants, heating and power stations, garbage incineration plants, the chemical industry, steelworks, metal foundries, the metal processing industry, and hot asphalt transportation.



FIRE AND FLAME RESISTANT CONVEYOR BELTS

During the transportation of bulk solids, challenges can occasionally arise, such as a potential self-ignition of the conveyed goods or even the conveyor belt itself. To ensure the utmost safety, our expert team has designed specialized fire and flame-resistant rubber materials, raising the level of safety precautions to its maximum.

Designation	Elastomer	Hardness ± 5 (Sh °A)	Abrasion max. (mm ³)	DIN / ATEX classification
K	SBR/NR	63	160	Fire and flame-resistant rubber conveyor belt for overground applications according to: <ul style="list-style-type: none"> • EN 12882: Category 2A, 3A • ATEX: Equipment group II, Category 3, zone G2/D22
S	SBR/NR	63	160	Fire and flame-resistant rubber conveyor belt for overground applications according to: <ul style="list-style-type: none"> • EN 12882: Category 3B. • ATEX: Equipment group II, Category 3, zone G2/D22
SMVO*	CR/BR	68	180	Fire and flame-resistant rubber conveyor belt intended for use in explosive atmospheres overground, endangered by mixtures of air and gases, vapors, or mists or by air and dust mixtures. <ul style="list-style-type: none"> • EN 12882: Category 3A, 3B, 4A, 4B, 5A. • ATEX: Equipment group II, Category 2, zone G1/D21
SMVU*	CR/SBR/BR	68	180	Fire and flame-resistant rubber conveyor belt intended for use in underground parts endangered by firedamp (presence of flammable gases especially methane) and/or combustible dust (any material in solid form that has ability to disperse into air, catch fire and explode if exposed to an ignition source): <ul style="list-style-type: none"> • EN 14973: Category A, B2 • ATEX: Equipment group I, Category M2

* Certificates available upon request

Our fire and flame-resistant conveyor belts are designed specifically for a range of applications. They are well suited for use in heating and power stations, and garbage incineration plants. Additionally, these belts are suitable for coal loading and transportation, as well as for use in steelworks and foundries. They are particularly suitable for closed conveyors, handling flammable goods, operating in potentially explosive areas, and near flame sources. Moreover, our fire and flame-resistant belts are ideal for tunnel constructions and underground mines where safety is paramount.

OIL AND GREASE RESISTANT CONVEYOR BELTS

As a rule, oils, and greases have a very destructive impact on rubber; however, materials that contain oil or grease are conveyed daily. To protect rubber components in the conveyor belts from swelling, oil and grease-resistant types of rubber should be applied. Since not all oil and grease types are equally aggressive, our engineers have developed different belt types to meet all the requirements.



Designation	Elastomer	Hardness ±5 (Sh °A)	Abrasion max. (mm ³)	Swelling of covers in oil; measurement according to ASTM D471 standard				
				Testing condition		IRM 901	IRM 902	IRM 903
RMG PLUS	NBR/SBR	65	130	22 h / 70 °C	RC	3 %	10 %	20 %
MOR	NBR/SBR/ BR	61	130	22 h / 70 °C	RC	5 %	15 %	30 %
MG PLUS	NBR/SBR	65	150	22 h / 70 °C	RC	3 %	10 %	20 %
GMG SUPRA	NBR	63	100	22 h / 70 °C	RC	10 %	5 %	5 %
KMOR	NBR/BR	60	150	22 h / 70 °C	RC	3 %	10 %	20 %
KGMG	NBR	62	200	70 h / 100 °C	RC	5 %	5 %	20 %

Additional qualities are available on request, inquire with our specialist

On the other hand, the oil resistance level of the belts depends on the specific construction, including factors such as the ratio of cover to skim, cut or molded edges, and the presence or absence of the bottom cover.

Our oil and grease-resistant conveyor belts are highly suitable for various applications, including concrete plants, recycling and mineral processing plants, waste sorting and compost machines, the metal processing industry, scrap recycling, the timber industry and sawmills, excreta and sewage sludge convey-

ing, corn, rape, and soilage conveying, as well as the paper industry and handling of fertilizers. These belts are specifically designed to cope with the challenges posed by oils and greases, which is why they are the ideal choice for industries dealing with such materials.

FOOD-GRADE (FDA) CONVEYOR BELTS



CARRYGREEN



CARRYBLUE



In the agriculture and food processing industries, conveyor belts play a crucial role. When it comes to conveying products intended for human consumption, using non-food grade conveyor belts is unsuitable. It is vital to ensure that the conveyed products remain uncontaminated by the belt itself, and that any particles released from the belt pose no risk to human health. Conveyor belts find application in various stages of the agriculture and food processing industry, including harvesting, washing, processing, storage handling, and food packaging. At our company, we specialize in producing a wide range of conveyor belts that meet the strict

standards of the highly-regulated food production and agriculture sectors.

Our food-grade conveyor belts and rubber sheets are designed to meet the requirements of several regulatory bodies, including the **Framework Regulation (EC) 1935/2004**, the **German Federal Institute for Risk Assessment (BfR)**, and the **Food and Drug Administration (FDA)**. We prioritize the safety and compliance of our products to ensure they are suitable for use in the demanding environments of the food industry.

Different qualities and constructions available.

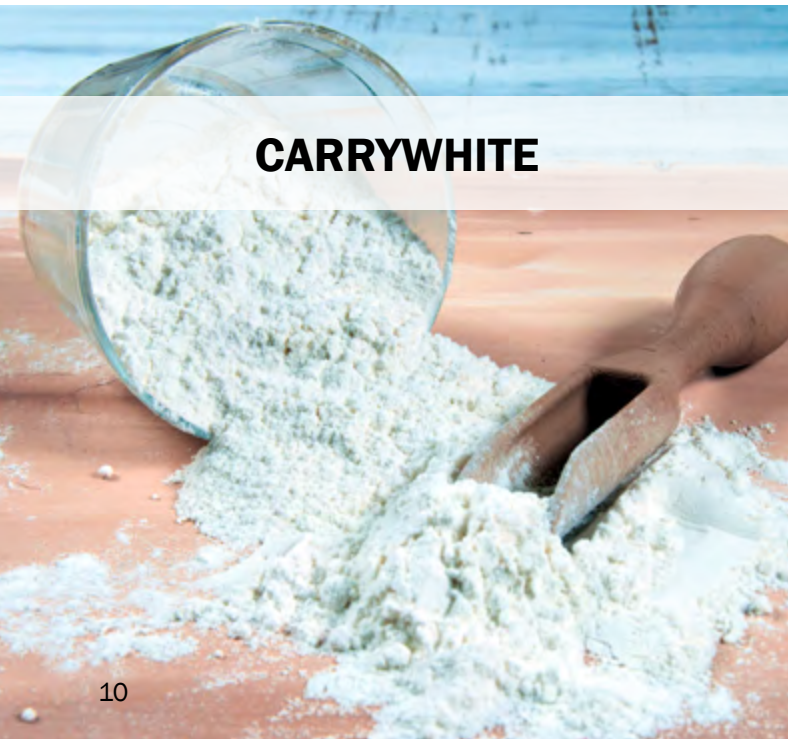

CARRYWHITE



CARRYBLACK

PAH-FREE CONVEYOR BELTS

PAH, short for **Polycyclic Aromatic Hydrocarbons**, includes a group of chemical compounds commonly found in coal and oil-based products and known for their harmful effects on human health and the environment. Any **PAH-free** labeled product has undergone a thorough testing procedure to verify absence of detectable levels of such substances. Our food-grade conveyor belts and rubber sheets meet the requirements of the **German Committee for Product Safety (AfPS – GS Specification)**.

To ensure consumer safety and regulatory compliance, products with which consumers are in direct contact or they may be exposed to, such as toys, cosmetics, food packaging, and special building materials, are often labeled PAH-free. Additionally, products made from rubber, plastics, and other materials derived from coal and oil may also have the PAH-free labels, indicating the manufacture without the presence of these potentially harmful compounds.





Chevron Belts

CHEVRON CONVEYOR BELTS



Discover our range of conveyor belts designed to cater to various industries and applications. With a maximum inclination **angle of 22 degrees**, our smooth conveyor belts can efficiently transport a wide range of materials. When your operation requires greater angles of inclination, our chevron belts offer the perfect solution. Developed by our expert engineers, these high-performance and high-quality conveyor belts feature homogeneous chevron profiles that are vulcanized to the base belt for exceptional durability and flexibility. Our chevron conveyor belts excel in diverse industries such as quarries, sandpits, cement works, lime works, farming (for conveying beets, grains, potatoes, fertilizers, and woodchips), coal and coke transport, sugar refineries, salt mines, mobile crushers and screens, as well as in road milling machines.

With a focus on custom-made design, our chevron conveyor belts are available in different types, including **A, AC, AH, F, and AF**. Each type offers unique

advantages and is tailored to suit specific industries and material requirements. The variations in chevron shape (open or closed) and cleat height provide versatility and enhanced performance. Our chevron conveyor belts find application in a wide range of industries such as **mining, agriculture, construction, recycling**, and more. We understand the importance of meeting industry-specific needs, which is why we engineer the belts that ensure the optimum performance and reliability of your operations. When choosing the appropriate profile type and height for your conveyor belt, various factors such as the specific material to be conveyed and the angle of inclination must be considered. It is essential to consider variables like goods type, loading conditions, and conveyor belt speed to make the right choice.

Trust our conveyor belts to provide reliable and efficient transportation, backed by our expertise and commitment to meeting industry standards.

Type of material	Material example	Max. angle of inclination		
		Height of cleats		
		Profile type A, h: 16 mm	Profile type AH, h: 25 mm	Profile type AF and F, h: 32 mm
POWDERY	Flour, lime, etc.	25°	28°	30°
LOOSE FLOWING	Grains: corn, barley, wheat, rye, dry sand	20/25°	25/30°	25/30°
LOOSE ROLLING	Gravel, ground stone	25°	28°	30°
STICKY	Wet sand, ash, wet loam	30/35°	35/40°	40/45°
PACKED	Sacks, jute sacks, paper sacks	30/35°	35/40°	35/40°

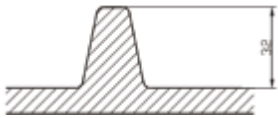
Angle of inclination is subjected to idlers speed, diameter... please inquire with our specialist

We specialize in manufacturing chevron belts that are noted for their exceptional qualities and meet the requirements of different industries. Our range includes **anti-abrasive, temperature-resistant, fire and flame-resistant, oil and grease-resistant, food-grade (FDA), and clean cover belts**.

CHEVRON CONVEYOR BELTS

To offer a comprehensive solution, the range of conveyor belt widths spans from **350 to 2000 mm (with molded edges)**, and we can also accommodate specific width requests from **350 to 2100 mm (with cut edges)**. In this way, we provide our valued customers with customized solutions. Additionally, we are flexible in manufacturing reinforced belts offering several options such as a **textile breaker, RC, or RCH (rip check cords)**, or a customized carcass tailored to the specific application needs. As we recognize the significance of different operating conditions, we offer an extensive range of belt constructions of varying tensile strengths, ranging from **125 N/mm to 3150 N/mm**. That allows customers to choose the optimal construction that meets their specific

requirements and ensures reliable and efficient performance.

Our chevron belts utilize high-quality materials such as multiply **EP carcass (warp polyester + weft polyamide)**, **EE carcass (warp polyester + weft polyester)**, or **EPP (warp polyester + warp polyamide + weft polyamide)** constructions. These materials, combined with our specialized rubber skimmed layer, ensure superior quality, enhanced fabric adhesion, and high abrasion resistance.

When it comes to performance, durability, and versatility, you can rely on our chevron belts to exceed expectations across a wide range of industries and applications.



CHEVRON CONVEYOR BELTS with A- and AH-type profiles

A 33 & AH 33

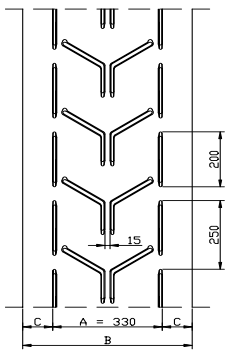

A 44 & AH 44

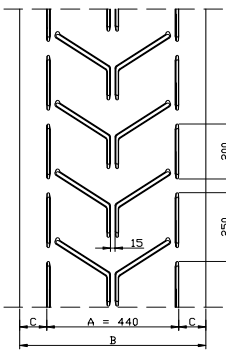

A 51 & AH 51

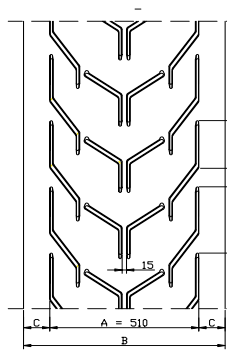

A 54 & AH 54

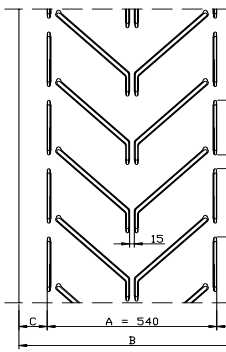

A 62 & AH 62

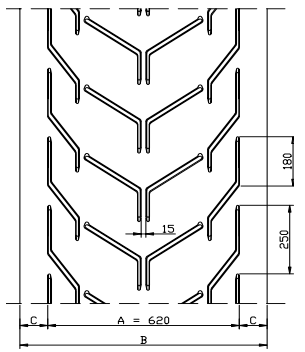

A 72 & AH 72

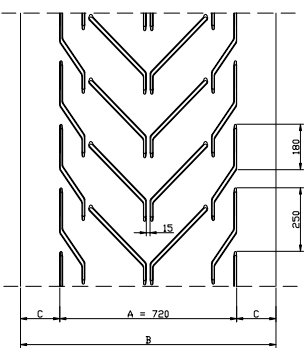

A 83 & AH 83

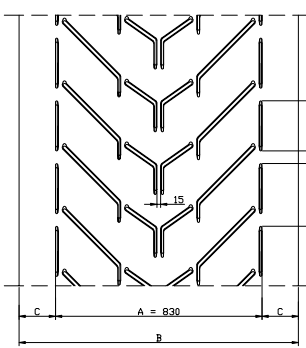

A 94 & AH 94

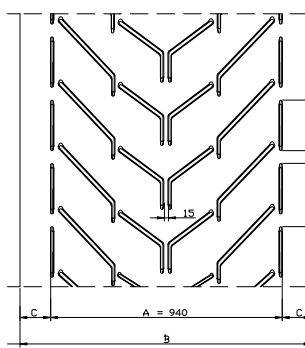

A 101 & AH 101

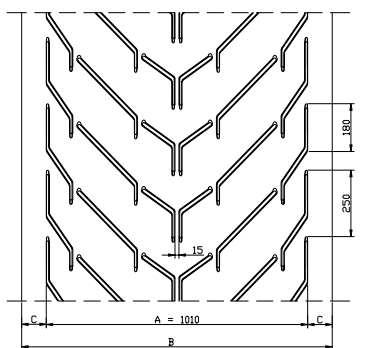

A 112, AH 112

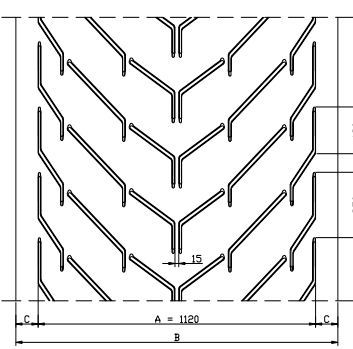

A 133, AH 133

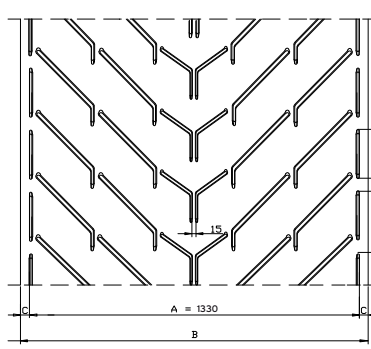

A 151 & AH 151

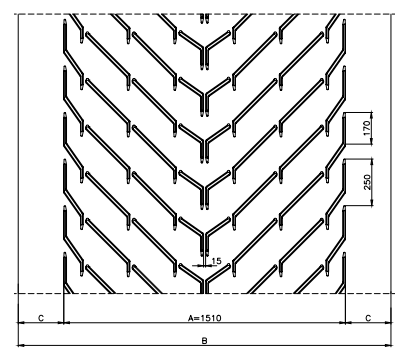

A 156 & AH 156

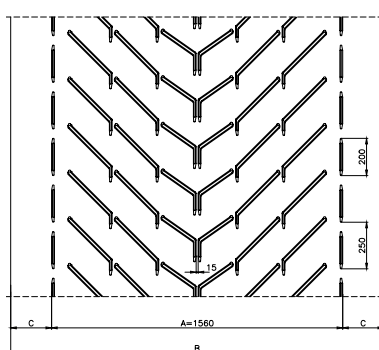

A 161 & AH 161

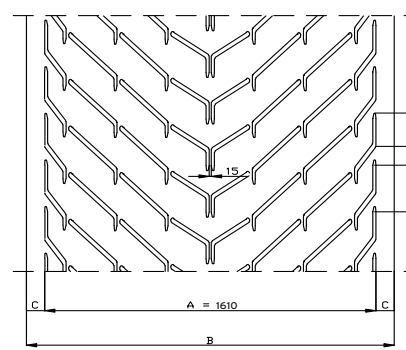

CHEVRON CONVEYOR BELTS AF-type

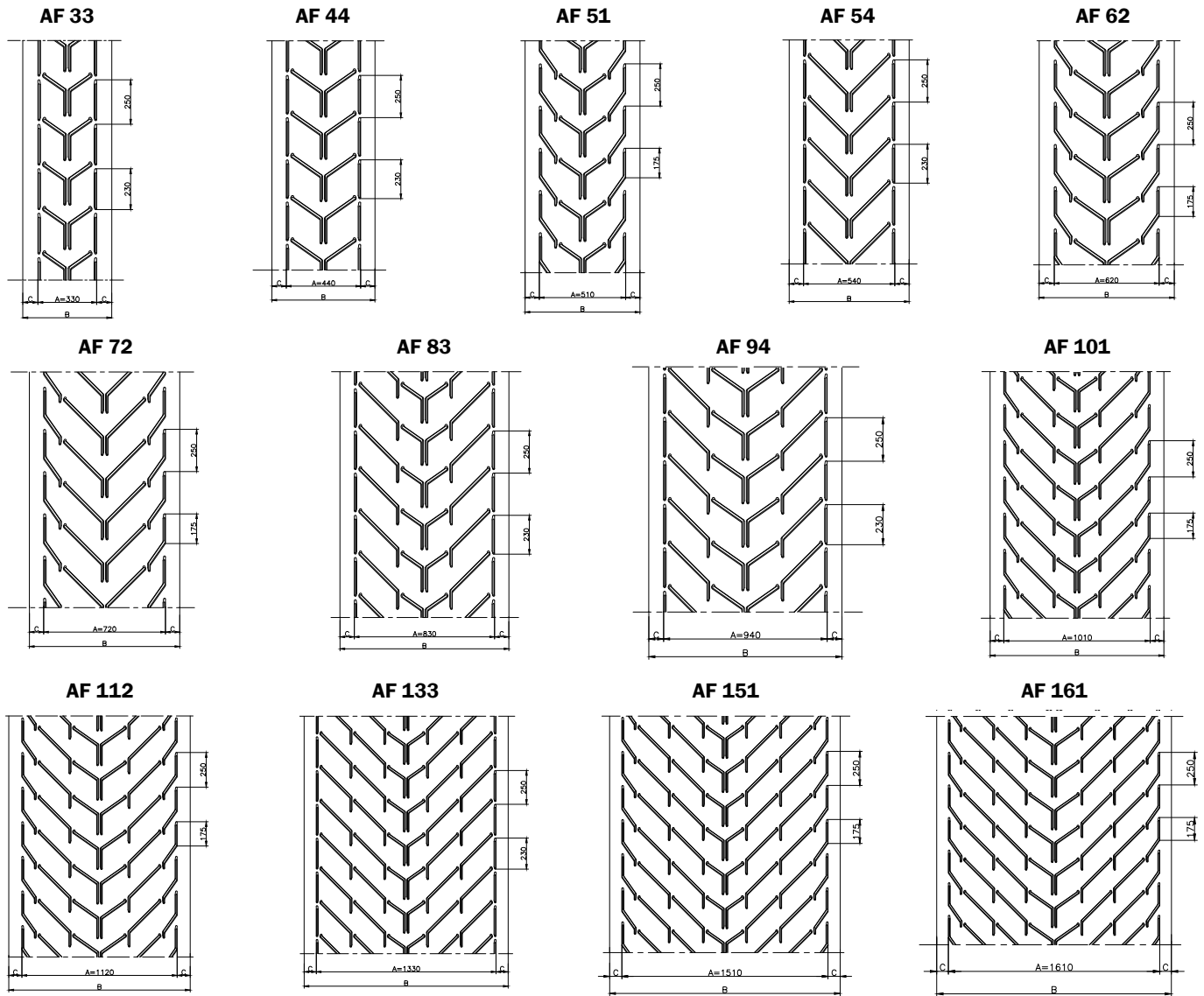

What are the main advantages of the new AF Chevron conveyor belt?



Improved forming of the through on the conveyor.

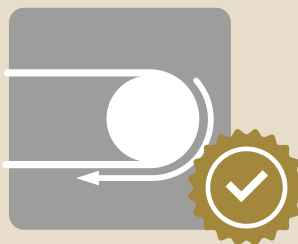

Smoother run on return side – less vibrations, longer service life of the equipment, lower costs.

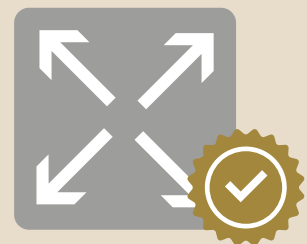

Better tension distribution and improved crack prevention on chevrons travelling over the drum.



Higher productivity due to improved design and flow of transported material.

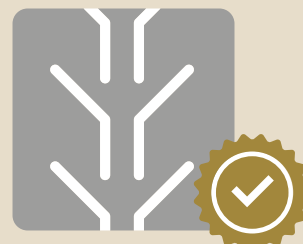

Shorter pitch, less material rolling backward.

CHEVRON CONVEYOR BELTS with F-type profiles



F 45

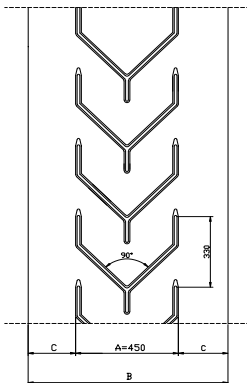

F 60

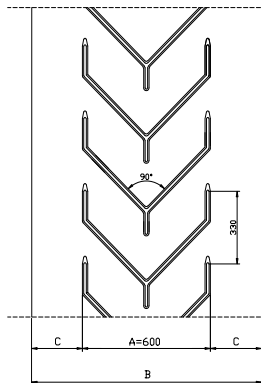

F 70

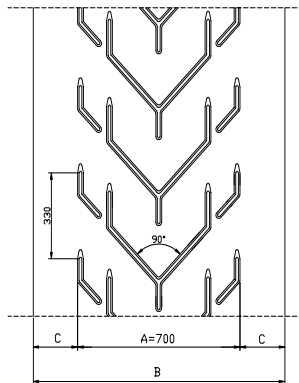

F 90

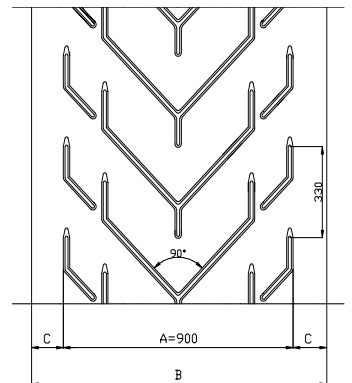

F 100

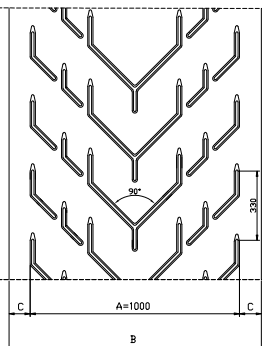

F 111

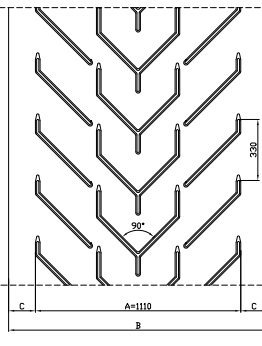

F 126

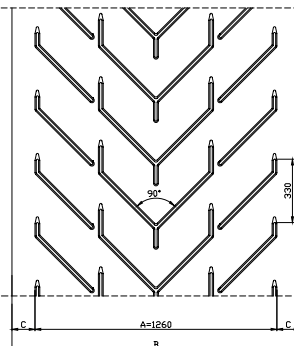

F 136

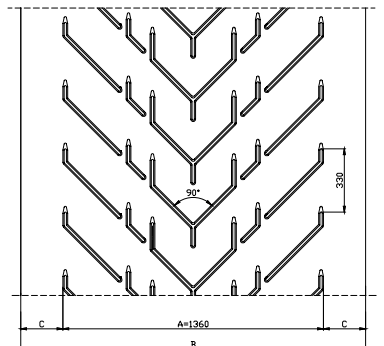

F 141

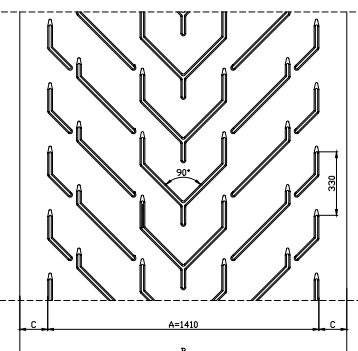

F 156

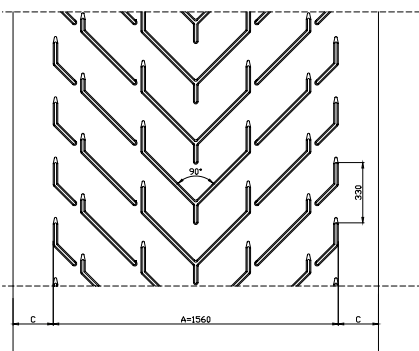

F 166

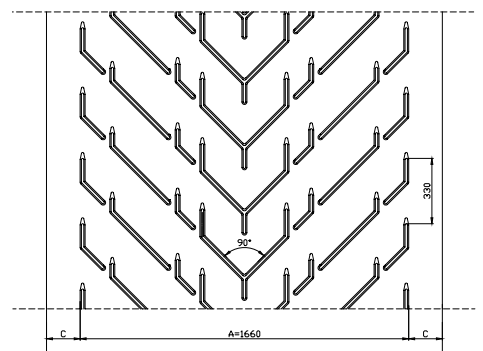

DESIGN YOUR UNIQUE CHEVRON

We offer our customers to choose and customize the belts to suit their specific needs and meet the demands of their customers. With our extensive experience and a strong R&D team, we can

manufacture uniquely designed chevron belts. We offer numerous customization options, not only for the belt's surface but also for its rubber quality and construction, allowing for a tailor-made solution.

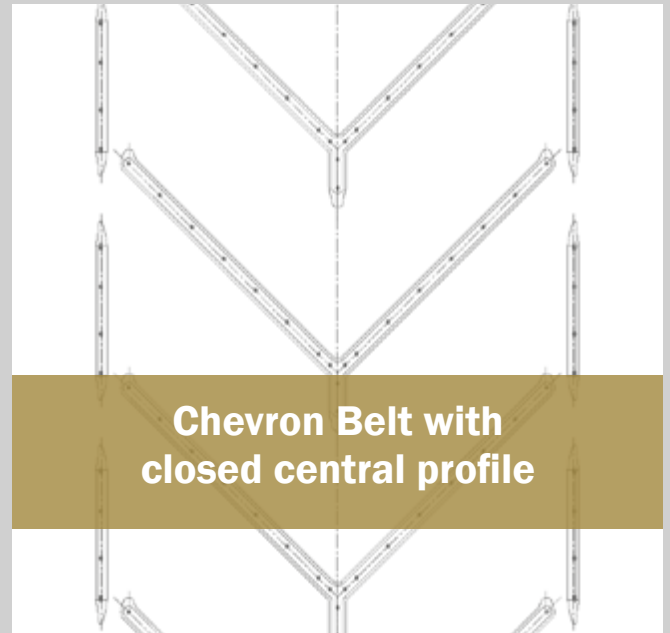

Design your unique chevron belt, tailored to your needs!

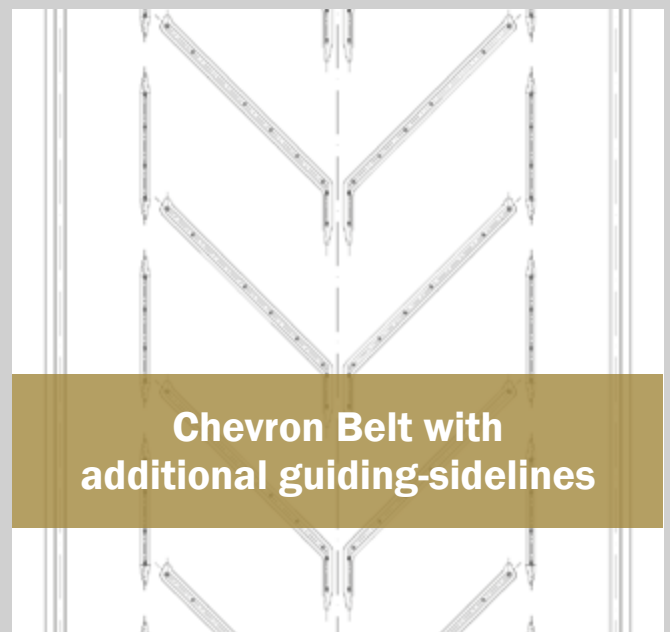
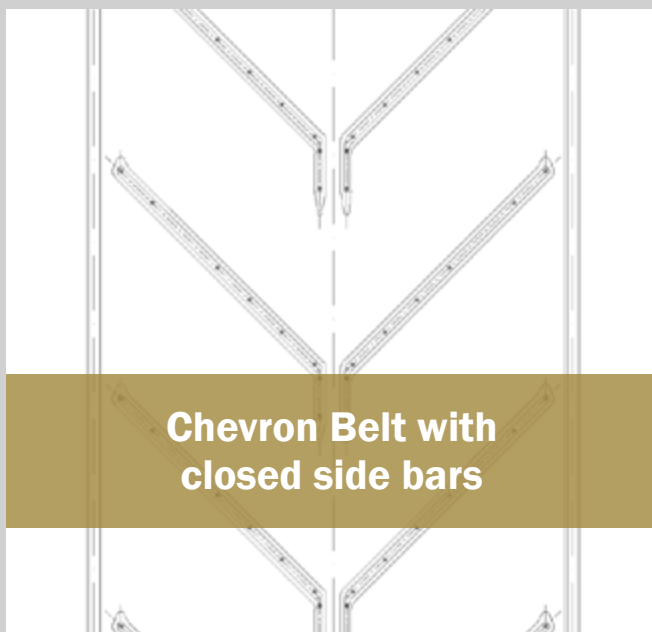

Special Surface Belts

L-TYPE CONVEYOR BELTS

Our Type L profile conveyor belts with a profile height of **8 mm (reversible)** are available in combination with **Ripcheck** and various rubber cover types, which makes them versatile for transporting **grains, woodchips, fertilizers**, and more.

Profile	Profile width (A) [mm]	Belt width (A) [mm]	Freezone width (C) [mm]
L51	510	550 - 900	20 - 195
L64	640	650 - 1000	5 - 180
L77	770	800 - 1200	15 - 215
L103	1030	1050 - 1400	10 - 185
L142	1420	1450 - 2100	15 - 340

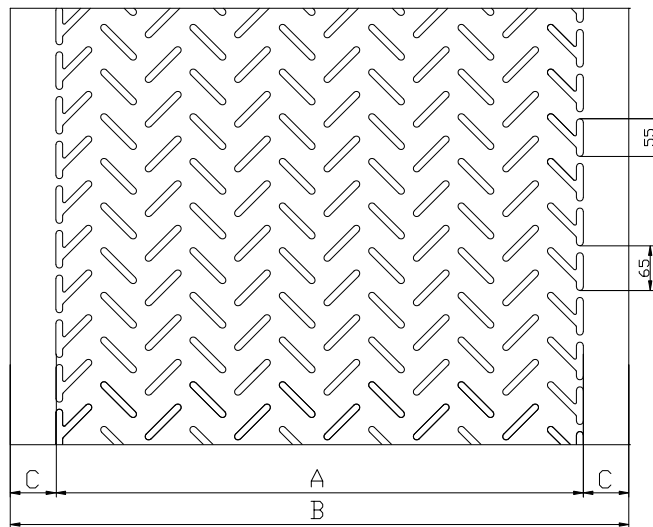

NOPPEN CONVEYOR BELTS

Our **NOPPEN** profile conveyor belts with a profile height of **3 mm (reversible)** are available in combination with **Ripcheck** and various rubber cover types, which makes them versatile for transporting **grains, woodchips, fertilizers**, and more. Noppen belts are specifically designed specifically for the conveyance of **very light materials, boasting a smooth return run and efficient cleaning properties.**

Noppen conveyor belts – PROFILE HEIGHT 3 mm

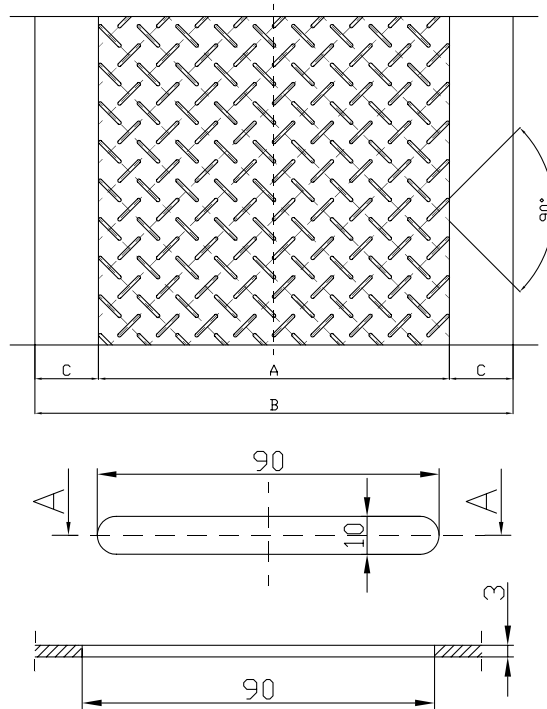

Profile	Profile width (A) [mm]	Belt width (A) [mm]	Freezone width (C) [mm]
NOPPEN540R	540	550 - 1000	5 - 225
NOPPEN750R	750	800 - 1200	25 - 225
NOPPEN1030R	1030	1050 - 1600	10 - 285
NOPPEN1600R	1600	1650 - 2100	25 - 250

SUPERGRIP, FINEGRIP AND MICROGRIP CONVEYOR BELTS

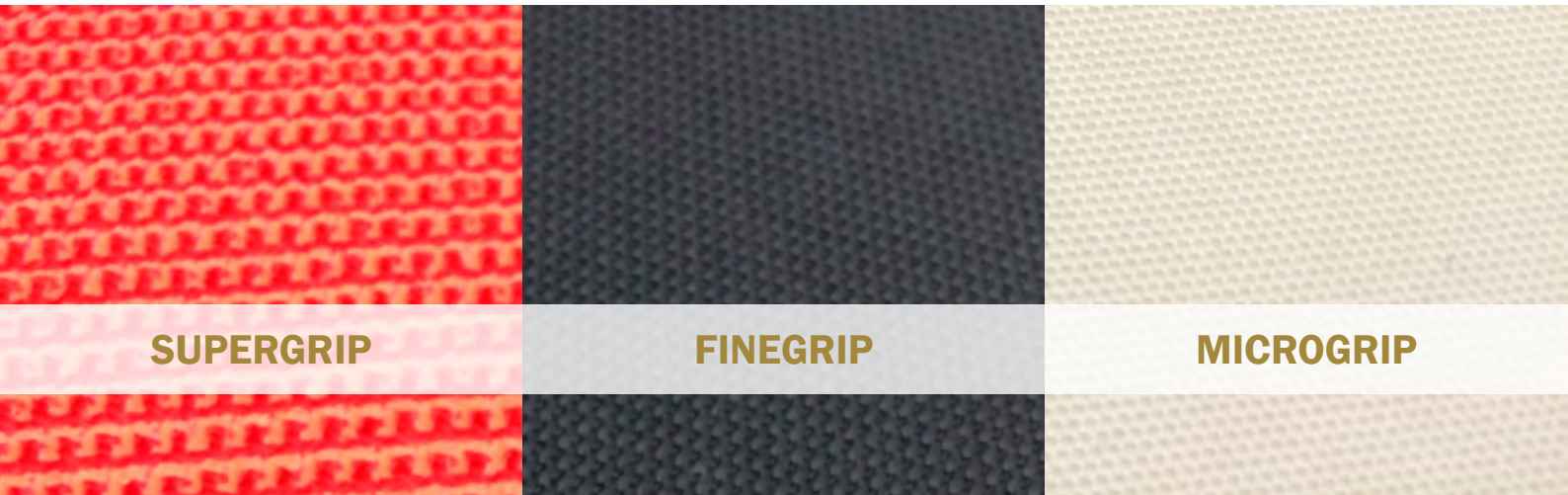

SUPERGRIP

FINEGRIP

MICROGRIP

We offer a diverse selection of specialized conveyor belts with unique surface structures, including **Supergrip (SG), Finegrip (FG), and Microgrip (MCG)** belts, specifically designed to address the challenge of material slipping during horizontal or ascending transport. Our innovative solution incorporates a **special rubber coating with high friction** and a **distinct surface design**. Our belt range include Supergrip belts that are well suited for conveying materials at **high angles** or in **wet and humid conditions**. Finegrip belts excel in **handling dust, fine-grained materials,** and **spills** while also providing **exceptional cleaning properties**.

Our conveyor belts employ different types of textiles, including **EP, EPP, EE-type,** and the **cross-stable EMF-type**, which is ideal for flat conveying without troughs. The **versatility** of our Supergrip, Finegrip and Microgrip conveyor belts makes them highly suitable for a wide range of applications. Whether it's **filling bags and packaging devices, transporting mail, facilitating bag, and reloading systems,** loading, and unloading piece goods, moving boxes and bottles, transporting baggage at airports and **railway stations,** facilitating **passenger transport,** conveying **timber and wood chips,** accommodating **round balers,** or supporting **stone/marble processing,** our conveyor belts deliver **reliable** performance and **tailored** solutions.





Special Construction Belts

SLIDING CONVEYOR BELTS

In conveyors without a rotating supporting roller, a sliding table is used to avoid the application of rubber coating on the belt's bottom surface for **prevention of increased friction**.

Our engineers have developed specialized sliding conveyor belts to **minimize friction** and ensure **smooth operation**. These belts can incorporate four types of textiles: **EP, EE, EPP, and EMF**.

Our sliding conveyor belts are widely applicable for the **timber industry, recycling plants, the packaging industry, airports**, and more. Each belt is customized to meet specific industry requirements, providing **efficient and reliable performance**.

With our specialized sliding conveyor belts, you can trust their **smooth operation**, even in systems without a rotating supporting roller.

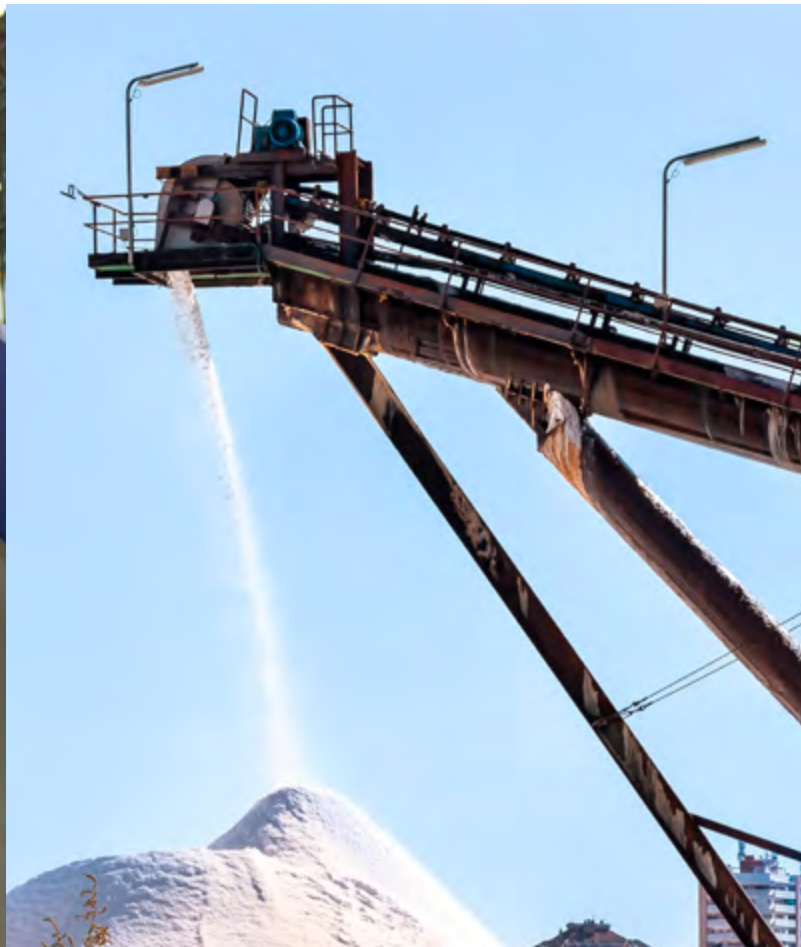

ELEVATOR CONVEYOR BELTS

Elevator conveyor belts are designed for a **variety of applications in belted-type elevators**. With their **durable carcass construction**, they are known for their **reliability** and **long service life**. These belts offer an **optimal solution** in terms of both **technical performance** and **cost-efficiency**.

Suitable for a wide range of industries and applications, elevator conveyor belts are used in the **sand, gravel, and stone industries; cement and concrete plants; heating and power stations, garbage incineration**

plants; asphalt mixing plants; recycling, compost, and mineral processing plants; the timber industry and sawmills; farming; warehousing and silo feeding; docks and ship loading/unloading; sugar refineries, salt mines, potatoes, and starch factories; foundries; and waste treatment plants.

With their **sturdy design** and **versatility**, elevator conveyor belts **reliably** meet the demands of different industries and ensure **efficient performance**.

PIPE TYPE CONVEYOR BELTS

Our team of engineers has collaborated with reputable conveyor manufacturers to develop an innovative pipe-type/tubular/tube conveyor belt. This specialized belt is designed for excellent performance in challenging conditions, especially for use with tubular-type conveyors. With its unique carcass construction, the pipe-type conveyor belt operates like a tube that remains closed and dust-tight during the transportation of bulk solids, even in horizontal or vertical curves.

The versatility of the pipe-type conveyor belt makes it suitable for a range of applications, including cement and concrete plants, heating and power stations, garbage incineration plants, REA or gypsum plants, the lime industry, tunnel construction, conveying dusty, fine-grained, and lower-density materials, environmentally hazardous materials, silo conveyors, and conveyors crossing roads (bridge conveyors).

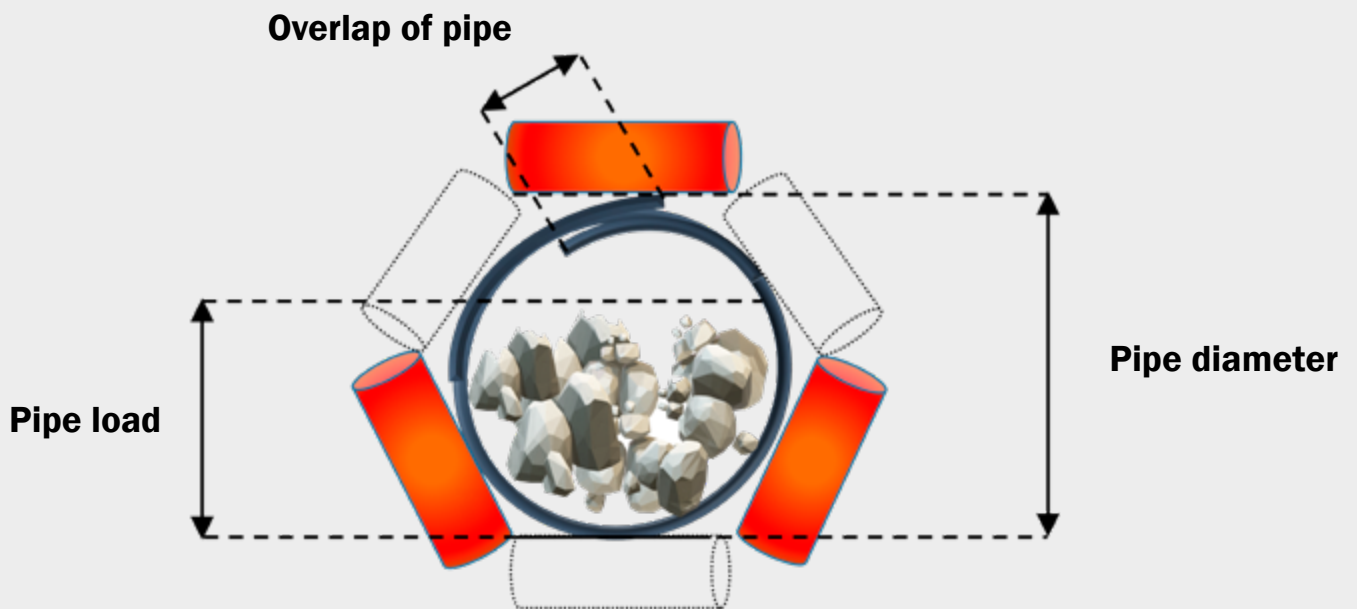

REINFORCED CONVEYOR BELTS

Conveying **bulk solids** can pose challenges, such as the risk of cuts or punctures in the belt due to **sharp-edged or large pieces, unfavorable feeding conditions, and material pileups**. To address this

issue, engineers have worked on finding a technical and **cost-efficient solution**. As a result, the **Ripcheck** conveyor belt was developed, featuring an additional **impact-resistant breaker** installed above the carcass.

The Ripcheck conveyor belt is available in different types, depending on the intended use and breaker:

- BR type: This variant utilizes **elastic reinforcement with textile cord**, suitable for applications involving **magnetic separators or devices for metal detection**, commonly used in the **timber industry**.
- RC type: It incorporates **elastic cross-reinforcement with steel cord**.
- RCH type: Designed specifically for **severe conditions**, it features a very **narrow** and **elastic reinforcement with steel cord**.

Reinforcement type	Reinforcement diameter [mm]	Average distance between the cords [mm]
Textile Breaker BR	0,55	1,40 (+/- 0,10)
Steel Cord SC	0,59	0,68 (+/- 0,20)
Steel Cord RC	1,19	14,0 (+/- 2,00)
Steel Cord RCH	1,19	0,90 (+/- 0,20)



STEELMAT CONVEYOR BELTS

Steelmat conveyor belts offer a **viable alternative** to textile carcass belts. They incorporate **special metal cords**, which makes them suitable for **long-haul conveyors and heavy-duty applications**. These belts exhibit **remarkable flexibility**, allowing for their use in applications with smaller pulley diameters while maintaining **high strength**.

Steelmat conveyor belts are available in different cover types: **anti-abrasive, clean cover, temperature-resistant, fire- and flame-resistant, oil- and grease-resistant, food-grade (FDA)-approved, PAH-free** composition (free of polycyclic aromatic hydrocarbons). They can be customized to meet specific quality requirements upon request.

Steelmat cord type	Warp	Weft	Belt range [N/mm]
IW (Impact weft)	E	HE	350 - 1600
IW-R (Impact weft + regular warp cord)	R	HE	630 - 2000
SW-HE (Straight warp + high elongation weft cord)	E	HE	350 - 2000
SW-RE (Straight warp + regular weft cord)	E	RE	350 - 2000

E - elongation steel, HE - high elongation steel, LE - low elongation steel, RE - regular elongation steel

CARRYFLEX CONVEYOR BELTS

CarryFlex belts have numerous **advantages** over conventional EP belts. They offer a **longer belt life**, which reduces the frequency of replacements and results in **lower operating costs**. Despite their lower weight, CarryFlex belts maintain the same tensile strength as EP belts, providing a lower thickness and weight while maintaining performance. Their design allows for smaller pulley and drum diameters. CarryFlex belts also exhibit **excellent rip, tear, and impact resistance** while their straight warp construction **minimizes stretch and elongation**. Additionally, they

provide **excellent load support, troughability, and tracking**, resulting in a **more balanced conveyor belt system**.

Engineered by our team of experts, CarryFlex belts can be **spliced using various techniques**, such as mechanical or hot vulcanization splicing, while retaining the exceptional properties of the product. These belts are available in different qualities and widths, with two notable variants: **EPP (M)** for mechanical splicing and **EPP (V)** for vulcanization splicing.

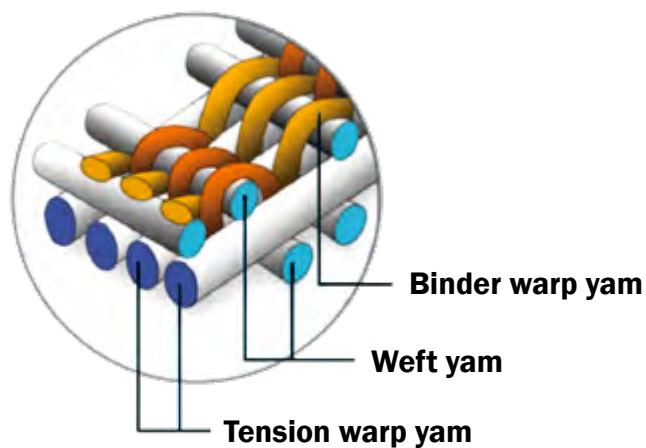

CROSSSTABLE CONVEYOR BELTS

Our range of cross-stable conveyor belts is suitable for use in various applications, including sliding conveyor belts and as base belts for corrugated sidewall conveyor belts in vertical conveying with sharp upturns. These belts are designed to maintain rigidity across their width (weft direction) and avoid forming troughs like traditional conveyor belts. However, they

are flexible along the length (warp direction) to ensure smooth operation over drums and pulleys.

We provide a selection of cross-stable conveyor belts, tailored to meet specific requirements, and to optimize performance in different industries and applications.

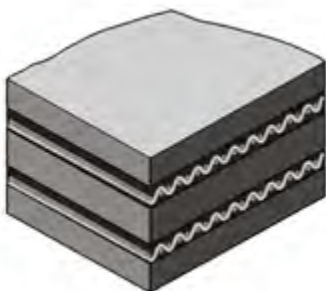

EMF-TYPE

Consists of multiple EMF textile layers

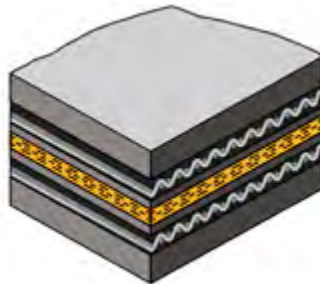

XE-TYPE

Combination of multiple textile carcass in the middle and EMF textile on top and bottom

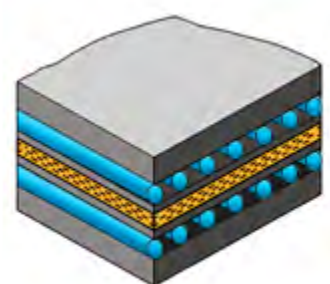

XE-SC-TYPE

Combination of multiple textile carcass in the middle and steel cord layers on top and bottom



Technical Rubber Sheets

TECHNICAL RUBBER SHEETS

We offer a wide range of **technical rubber sheets** of **various elastomer types, dimensions, and hardness grades**. Our rubber sheets are available in thicknesses ranging from **0.5 mm to 40 mm** and widths from **1000 mm to 1600 mm up to 1750 mm (without reinforcement) and 1850 mm (with reinforcement)**. You can choose between sheets with or without **fabric plies** for added strength. The

surface options include **smooth surfaces** on one or both sides and **textile patterns** such as **Supergrip (SG), finegrip (FG), microgrip (MCG), and smooth**. Additionally, some rubber sheets feature a **bonding layer**, either with or without a **CR layer (chloroprene rubber)**. We aim to offer a comprehensive selection of technical rubber sheets to meet a wide range of application needs.

Type	Elastomer	Properties
A	NR	<ul style="list-style-type: none"> good elasticity and flexibility good mechanical properties
B	SBR	<ul style="list-style-type: none"> good mechanical properties
C	NBR	<ul style="list-style-type: none"> good mechanical properties, resistance to vegetable and mineral oils resistant to gasoline containing not more than 30 % of aromatic compounds
CIIR	IIR / CIIR	<ul style="list-style-type: none"> good temperature resistance good ozone stability resistant to polar solutions resistant to acids and bases
D / CR	CR	<ul style="list-style-type: none"> high physical and mechanical values good ozone stability resistant to aliphatic oils good adhesion with metal
E	EPDM	<ul style="list-style-type: none"> good temperature resistance good ozone stability resistant to polar solution good chemical resistance

Rubber lining and wear protection

Our technical rubber sheets offer **dual functionality as protective linings** for various applications. Designed to protect **against wear and corrosion**, these sheets ensure **long-lasting durability** for underlying

constructions. With **exceptional abrasion and wear resistance**, they effectively shield equipment and surfaces against the damaging effects of friction.

Designation	Colour	Hardness ± 5 [Sh ° A]	Max. abrasion ± 20 [mm ³]
B75	black	73	90
B60 W	black	60	70
A65	black	65	100
B63 WL SUPRA	black	64	40

Skirting boards and cleaners

Our **spillage prevention system with rubber skirting boards** is essential for **high-speed conveyor belt operations**, reducing risks and **extending equipment life**. Combined with regular cleaning using conveyor belt cleaners, our rubber sheets **enhance efficiency,**

minimize downtime, and promote workplace safety. Their use, along with **proper cleaning practices**, prevents material build-up, ensures **optimal performance and long life** of the conveyor system.

Designation	Colour	Hardness ± 5 [Sh ° A]	Max. abrasion ± 20 [mm ³]
C65	black	68	resistance to oil and grease
A40 RED	red	40	non-staining and non-marking
A35	black	35	anti-dust protection

TECHNICAL RUBBER SHEETS

Corrosion and chemical protection

Our specialized sheets provide **strong protection against corrosive substances** and shield the equipment against **acids, solvents, alkalis, and**

other chemicals. With a wide range of formulations available, we can meet specific requirements and ensure optimal asset protection.

Designation	Colour	Hardness ± 5 [Sh °A]	Properties
CI IIR45	black	45	resistance to acid and temperatures
D68	gray / black	68	resistance to sea water and ozone
E67	black	67	resistance to acids, ozone and temperatures

Drum/pulley lagging

Achieving **optimal friction** and preventing **belt slipping** is vital for smooth conveyor belt operation. Our specially developed rubber drum lagging ensures **excellent friction** by lining the drums. With a **square pattern** design and optional **gray chloroprene rubber**

layer, our drum lagging provides **reliable adhesion to metal surfaces.** We offer a range of drum/pulley laggings in different quality types, including **abrasion-resistant, oil-resistant, and food-grade** rubber, available in **various colors.**

Designation	Colour	Hardness ± 5 [Sh °A]	Properties
B60 Y	black	60	abrasion resistant
C60 MOR BLUE	blue	60	oil resistant and FDA Approved
C65 SB-KMOR	white	65	fire and oil resistant and FDA Approved

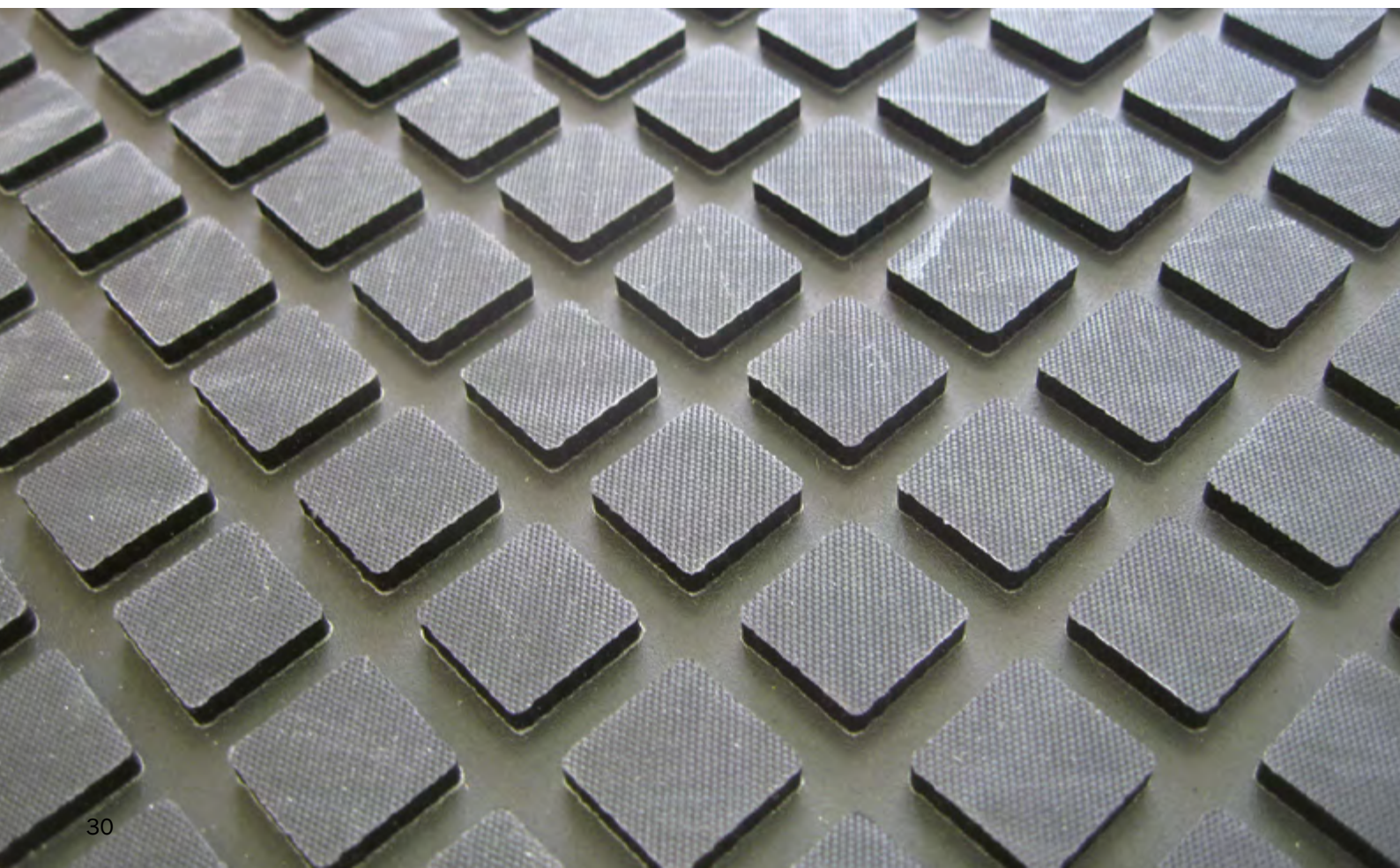



TECHNICAL RUBBER SHEETS

Rubber sheets for food processing industry

Rubber sheets are essential in the **agriculture and food processing industry**, just like conveyor belts. While regular black rubber sheets are suitable for the initial processing stages, special **food-grade** rubber

sheets are required in processing at later stages. Our engineers have developed a variety of **food-grade rubber sheets** to cater to the specific needs of the food processing industry.

Designation	Colour	Hardness ± 5 [Sh ° A]	Application
B60 CARRYWHITE	white	60	skirt boards and cleaners
B60 CARRYGREEN	green	60	skirt boards and cleaners

Rubber sheets for electrical insulation

Rubber can act as a **good insulator** and is suitable for use in the **electrical industry** according to **SIST EN 60243-1:2001 standard**. Our engineers have

developed a special product used for rubber lining – B70, which prevents **electrical conductivity up to 50kV**.

Designation	Colour	Hardness ± 5 [Sh ° A]	Properties
B70	gray	70	power stations, transformers

Fire-resistant and antistatic protection rubber sheets

Fire-resistant rubber sheets are crucial in environments such as **underground mines, closed conveyors, steel factories, and foundries**. They provide a protective lining to **prevent static electricity**

discharge, especially in high-risk areas like **precision mechanical workshops, lacquering plants, and gasworks**, where the consequences can be fatal.

Designation	Colour	Hardness ± 5 [Sh ° A]	Properties
B62 K	black	63	closed conveyors, steel factories, foundries
B67	black	67	gas companies, paint shops

Rubber sheets for gaskets, sealing systems

We provide a wide range of rubber sheets suitable for **sealing applications**. Depending on the specific conditions and requirements, we offer options such

as **oil-resistant** rubber sheets, **food-grade** quality rubber sheets, and rubber sheets designed for **dust sealing systems**.

Designation	Colour	Hardness ± 5 [Sh ° A]	Properties
C70	black	68	gaskets in contact with oils and grease
P40	red	40	gaskets in food processing industry
A35	black	35	dust sealing systems



**Finding solutions
for every need**

TRELLEBORG SLOVENIJA'S – VISION AND MISSION

Trelleborg Slovenija is a subsidiary of the **Trelleborg Group, a global leader in engineered polymer solutions.** Trelleborg Slovenija is located in **Slovenia, Europe,** and is a manufacturing facility specializing in various rubber products and solutions. The group offers a comprehensive range of rubber-based products, including industrial hoses, sealing solutions, conveyor belts, and other engineered rubber components. These products cater to numerous industries, such as **automotive, aerospace, energy, agriculture, and construction.** Trelleborg Slovenija is known for its commitment to **quality, innovation, and customer satisfaction.** The company leverages **advanced**

manufacturing technologies and processes to ensure the **highest product performance standards and reliability.** Furthermore, Trelleborg Slovenija emphasizes **sustainability and environmental responsibility** in its business operations. The company strives to minimize its ecological footprint by implementing **sustainable practices** and continuously improving its environmental performance. With its expertise **in rubber engineering, commitment to quality, and focus on customer needs,** Trelleborg Slovenija continues to provide **innovative solutions** that meet the demands of various industries and contribute to the **success of its customers worldwide.**

Agriculture & Forestry

Oil & Gas

Automotive & Manufacturing

Renewable energy & Power generation

Building & Construction

Food processing

Mining & Material handling

OUR KEY INDUSTRIES

OUR CAPABILITIES

In-house mixing

In-house central laboratory

Innovations & improvements for more than 70 years

Virtual development

Quality management & intersectoral cooperation*

* ISO 9001, IATF 16949, ISO 14001 and ISO 45001

As a comprehensive rubber manufacturer, we specialize in providing **turnkey solutions** tailored to your **specific needs.** Our dedicated team works closely with you to understand your requirements and develop **customized products** that meet your expectations. Whether you require rubber components for

industrial applications, sealing solutions, or other specialized rubber products, we are **committed** to finding the right solutions for you. Drawing upon our **expertise and customer-centric approach,** we strive to exceed your expectations and provide **high-quality** rubber solutions for your unique challenges.



WWW.TRELLEBORGSLOVENIJA.COM
WWW.TRELLEBORG.COM/EN/SEALS-AND-PROFILES



youtube.com/c/TrelleborgPipeSeals
linkedin.com/company/trelleborg-seals-profiles/