

Trelleborg 582 Din-Lock™

**Locked-in seal for
DIN-grooved plastic
pipes and fittings
for wastewater and
cable protection**

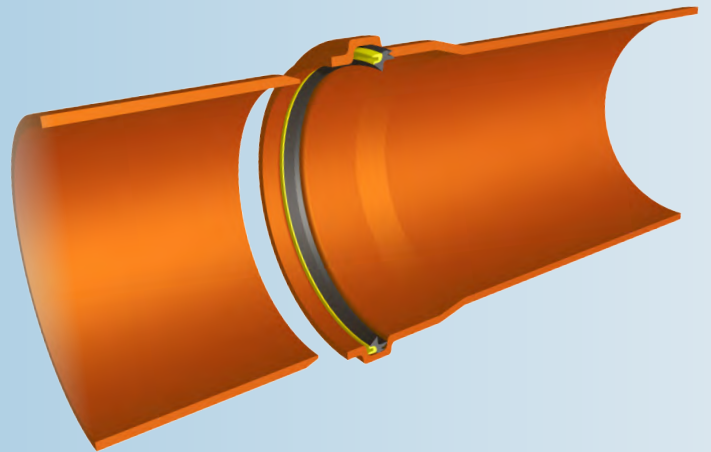

KEY FEATURES AND BENEFITS

- **Cannot be displaced during transport & installation**
- **Fully fills the groove to prevent dirt intrusion before joint assembly**
- **TPE-V for increased oil resistance**

SEAL DESIGN & FUNCTION

Trelleborg 582 Din-Lock™ is a combined lip and compression seal. Installed inside the socket after it has been formed, the retaining element effectively locks the seal into the groove.

Making the seal an integral part of the pipe brings many advantages: rings can no longer get lost during stocking and transportation, and the low jointing force ensures that the seal stays in place when pipes are jointed.

The unique design comprises of two elements:

1. A plastic retaining element that holds the seal securely in position
2. A rubber sealing element that ensures a watertight seal once the pipes are jointed

Together, they absorb any permissible variations in the groove.

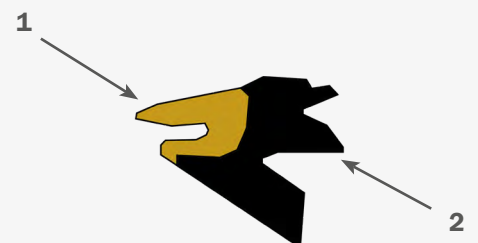

JOINT ASSEMBLY

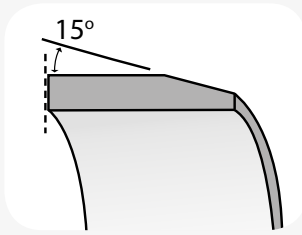

Inspect the spigot, socket and seal for damage and remove any dirt or dust prior to assembly. Chamfer the spigot end and remove all burrs.

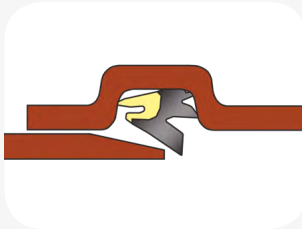

Apply lubricant to the spigot end and immediately bring it into contact with the socket.

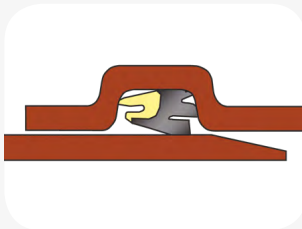

Align spigot and socket, and slide the spigot into the pipe, past the seal.

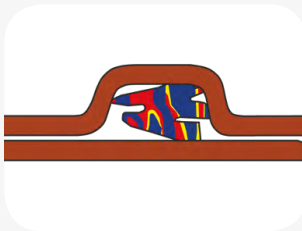

When two pipes are pushed together the rubber sealing element is designed to deform creating a sealing pressure acting on both spigot and socket.

SIZE CHART

PIPE SIZE (mm)	A (mm)	B (mm)
50	7.2	9.9
75	7.2	9.9
82	6.9	9.1
100	7.6	10.1
110	8.6	10.5
125	10.4	11.8
160	11.8	13.6
200	11.4	15.3
250	16.5	23.8
315	19.6	19.4
400	20.8	21.6
500	25.6	28.0

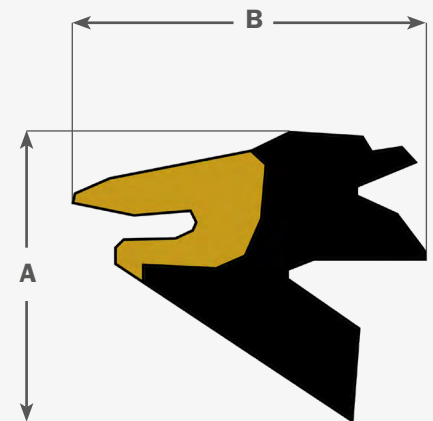

APPROVALS

- CE-marking
- BSI "Kitemark"
- Swedcert
- IRAM
- Komo
- Benor

STANDARDS

- EN 681-2 WT, WH
- BRL 2020
- IRAM 113061

MATERIAL

- Thermoplastic elastomer (TPE)
- Hardness 60+/-5 IRHD

Authorities we cooperate with:



TRELLEBORG

WWW.TRELLEBORG.COM/PIPE-SEALS