

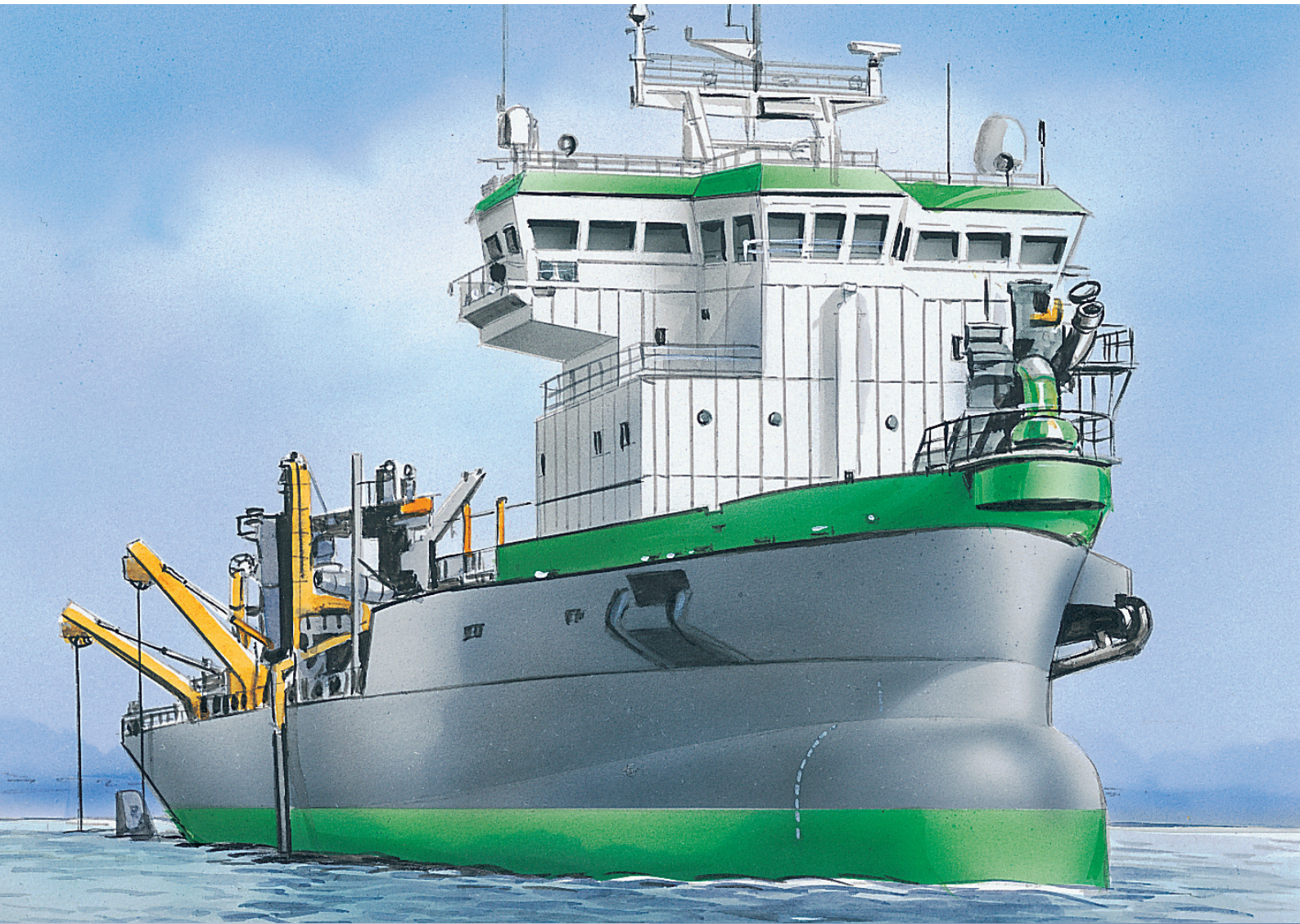

TRELLEBORG

Dredging hoses and applications

Trelleborg Ridderkerk



Introduction

Trelleborg Ridderkerk is made up of a team of professionals specializing in rubber material handling hoses, so that development, production, advertising and technical support are all under one roof. Our niche in our market is the international dredge industry, one which

believes that actions speaks louder than words.

We respond to this attitude with guaranteed product quality and an approach that goes down well throughout the world.

“Trelleborg Ridderkerk connects things”.



1

1 VOLVOX ASIA

Van Oord, The Netherlands

2 PALLIETER

Dredging International, Belgium

3 VOLVOX TERRANOVA

Van Oord, The Netherlands

4 CHARLEMAGNE

Dredging International, Belgium

5 JUAN SEBASTIAN DE ELCANO

Jan de Nul, Belgium



Dredge hoses demand reliability and safety which will withstand even the most extreme working conditions. Making these hoses is a job in itself. Our performance enjoys a great deal of confidence; flagships of the international dredge fleet are equipped with our products. Every dredge company will find all the hoses and flexible connections it needs in our product range. We offer reliable products, designed and produced using the very latest technology and methods and tried and tested in practice.

We trade under the flag of Trelleborg, the Swedish multinational with a world name in the rubber industry. We operate from Holland, a bulwark in the international dredge industry. Trelleborg Ridderkerk stands for over half a century's expertise in rubber material handling hoses.

Design Criteria

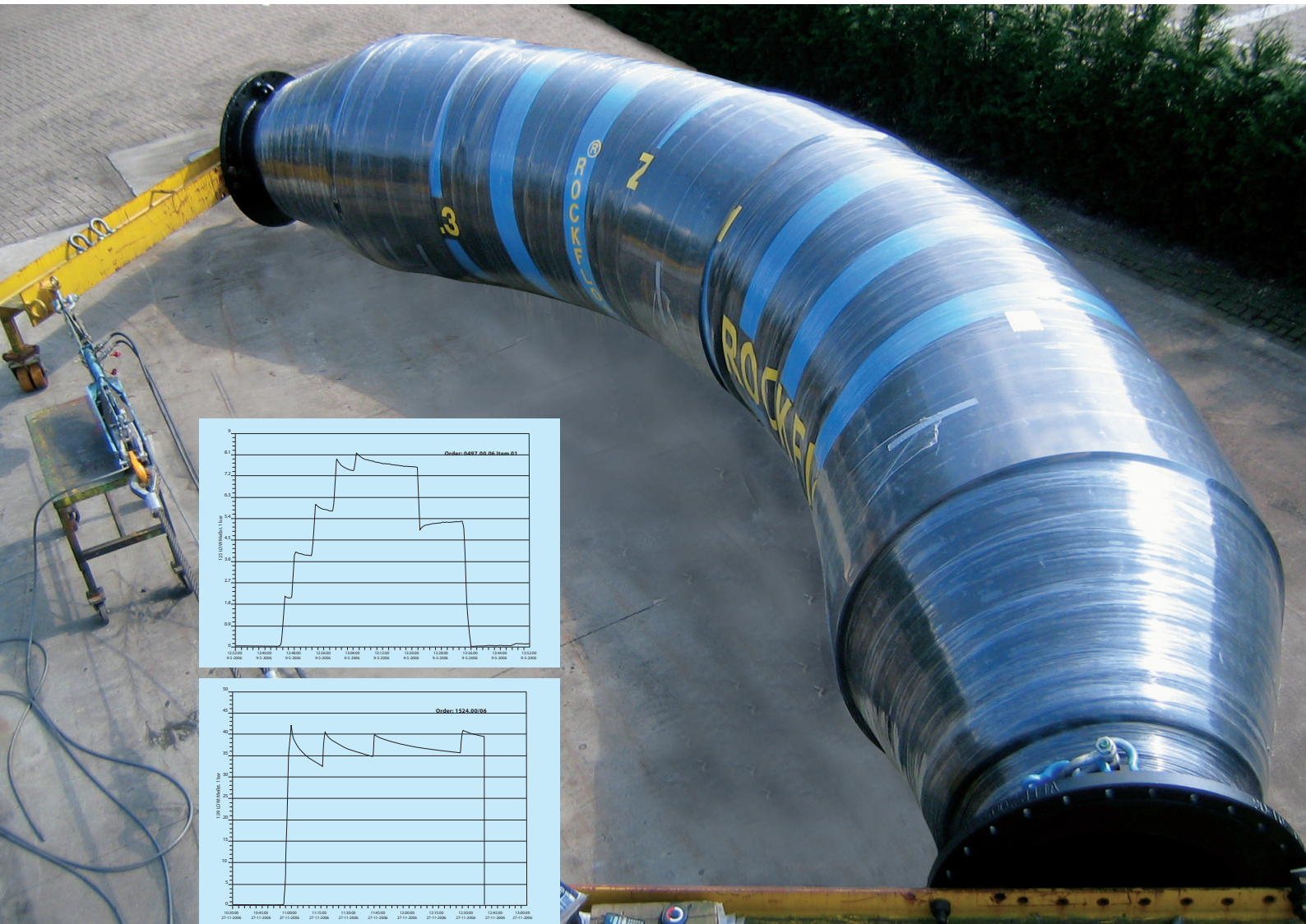

The basis of success is a flawless product. Our philosophy is as old as the company itself. It dates back to the beginning of the 50s and clearly states "We build the best rubber hoses for material transport using the latest state of the art technology and at a competitive price". Design criteria are selected on this basis and have always gone hand-in-hand with practical development.

Today, our design department uses the most advanced simulation programming and design methods. The advantage of these is that the customer's specifications are "translated" in the best possible way into the product required. But they also mean that our know-how can be used on a wider scale in practice - which enhances the quality of our consultation work. As far as we are concerned, problems with dredge hoses do not exist. And if they do, we simply solve them.

A dredge hose from Trelleborg Ridderkerk is a reliable product all along the line. This reliability is guaranteed in a number of ways, starting with the concept. Because of their high level of wear resistance and flexibility, rubber material handling hoses are, by nature, ideal transport lines. Hoses from Trelleborg Ridderkerk have proved to have a very long life in practice, even when pumping highly abrasive media.

Overdimensioning is added to this excellent starting point in the design phase; we always make a dredge hose much thicker than specified. This safety margin is used to give the hose an additional shield against unforeseen circumstances. Other guarantees of safety and reliability are

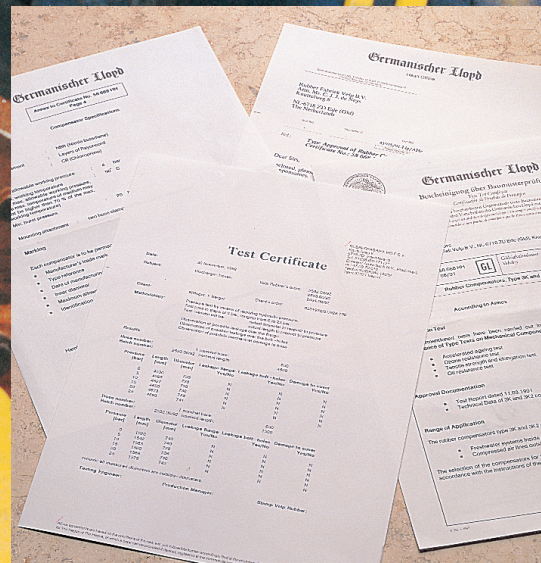
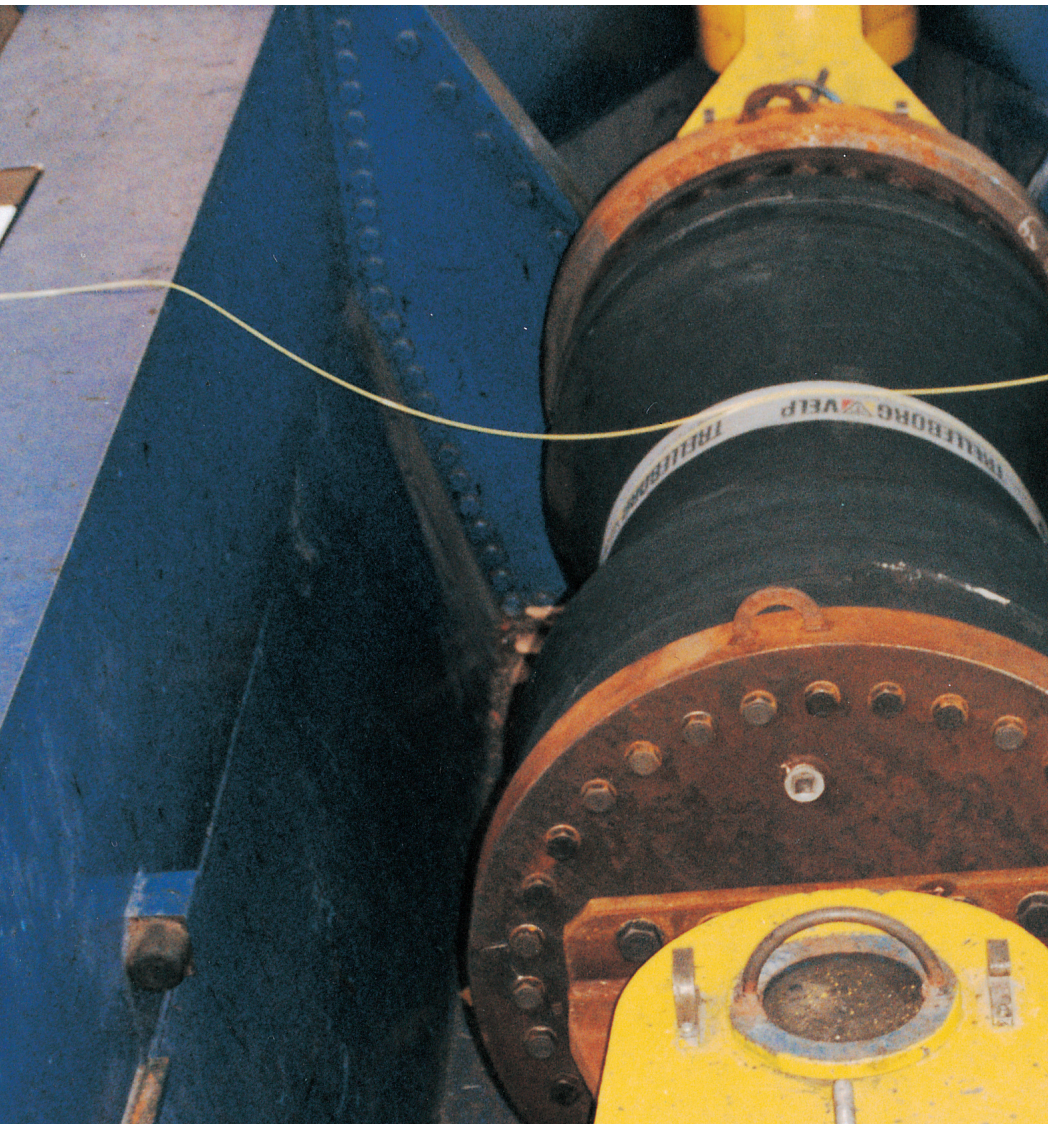

provided by our production control and test facilities. We can issue test reports for our products at the customer's request. But most of the tests which we carry out are intended for our own research. We also want to be sure at all times that we adequately satisfy all test and inspection requirements throughout the world.

Pressure test

Product Range

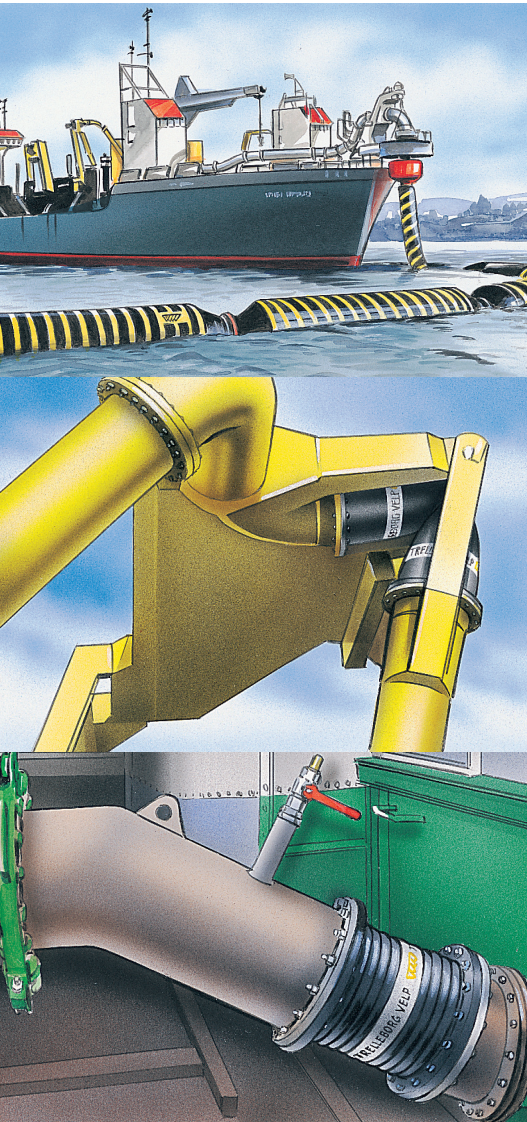

Our company is geared for fast and flexible delivery of tailor-made products to all corners of the world. Our production facilities and capacity has been carefully tuned to this requirement. We also offer a very complete range, which is divided into the following product groups:

- Pressure hoses and sleeves
- Suction hoses and sleeves
- Special types, like bucket and caprock hoses
- Selffloating hoses (Floatline)
- Compensators and expansion pieces
- Pre-shaped rubber bends
- Reducers
- Adaptors
- Breeches pieces
- Pinch valves

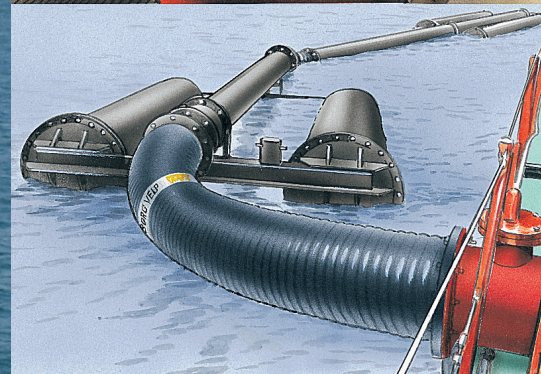
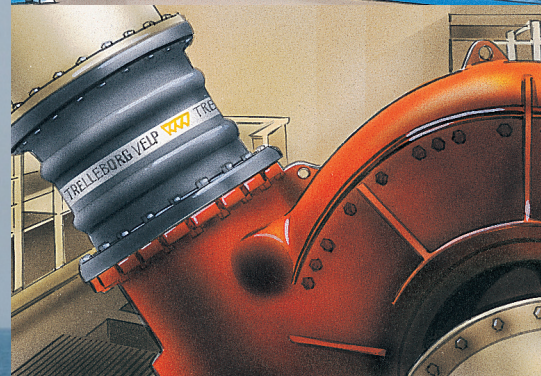
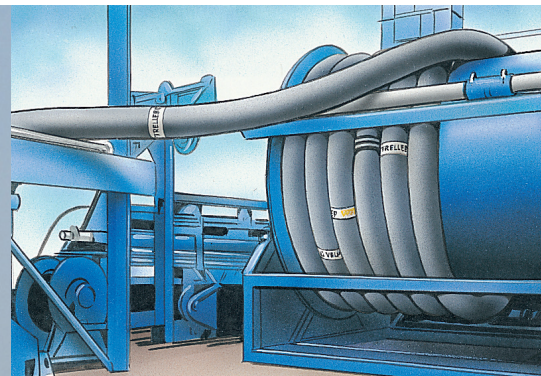

As high as a house or as long as a road

Our production is geared for short delivery times and we can make any hose required, the height of a house or the length of a street. The biggest diameter we can vulcanize is 4 meters. We can make hoses in lengths up to 30 meters, depending on the construction. And we can make practically any hose diameter within a range from 50 mm to 2000 mm.

We can vulcanise diameters up to 4 meters.

Raw Materials for Hoses

The most important materials for making material handling hoses are rubber compounds, cord materials and components like steel flanges, rings, etc. The compounds are made to our specification, supplied to size and processed by our own factory.

The composition of the rubber compounds depends on the intended use. For the inside of our hoses, for example, we use wear layer rubbers with a number of properties. In this way, we obtain a layer which combines an extremely high wear resistance with flexibility at very low temperatures and resistance to abrasion, protracted exposure to sea

water of different compositions and storage under tropical conditions.

The cord material we use is strictly selected for quality and function. We work with traditional materials, like rayon and polyester, but we also use new types of material, like aramide.

A material handling hose from Trelleborg Ridderkerk is always a tried and tested solution. It is designed to work impeccably in practice, from all points of view. With this in mind, our designers have developed and perfected a components program.



1



2



Different types of flanges and couplings available as standard

1 Straight ends for low pressure

A hose with straight ends can be connected in many ways. However, although cheap, this type of connection is only suitable for low pressures. One disadvantage is that when it is fitted in the pipe, it obstructs the flow through the hose. However, at low flow speeds, the turbulence caused by this is of secondary importance.

2 Low pressure collar

A hose with collars does not have this disadvantage. The end is widened so that the connector does not obstruct the flow when inserted. However, hoses with collars should also only be used with low pressures.

3 Rubber flange-steel backing flange for medium pressure and vacuum

This flange is used for medium pressures in suction hoses. The rubber flange means that the hose can remain relatively short, starting from a maximum angle of curvature. And because the wear layer rubber extends partly into the top edge of the flange, it forms a good seal with the flange connection itself.

4 Rubber flange, steel backing flange and gasket flange for larger bore suction-discharge applications.

Proper sealing at higher pressures is one of the main advantages of this flange system. The integrated steel insert flange at the flange face keeps the flange connec-

5 Double Action flange® in two designs

The Double Action flange is our most recent development. The main feature of this flange is the superior axial strength due to integrated locking flange. This flange is able to accept high bending loads due to thick integrated flange and backing flange and will not fall apart due to rust. Thick integrated flange and backing flange allow for a large radius in flange neck, no cutting forces on the cords. The Double Action flange comes in two designs: the plain Double Action flange and the Double Action flange with steel gasket flange. The latter gives even better sealing at high pressures and offers protection to the reinforcement cords when mounted to sharp edged raised face flanges. We recommend this flange for

3

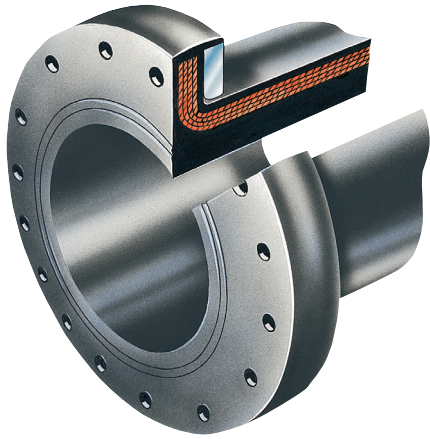

4

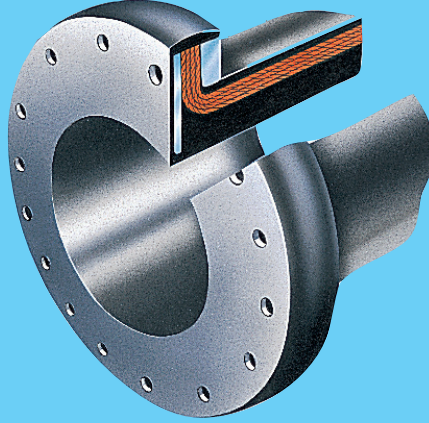

5

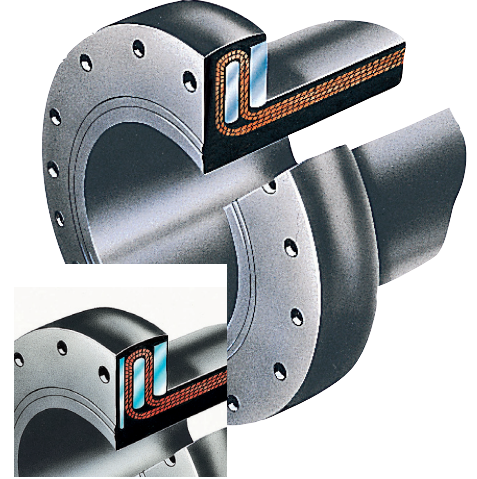

6

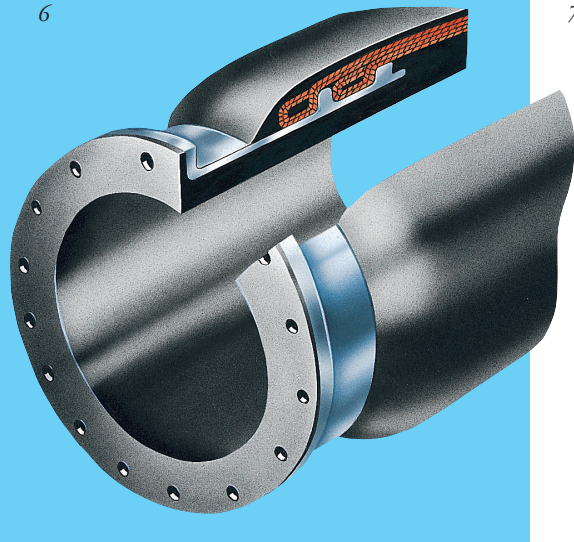

7

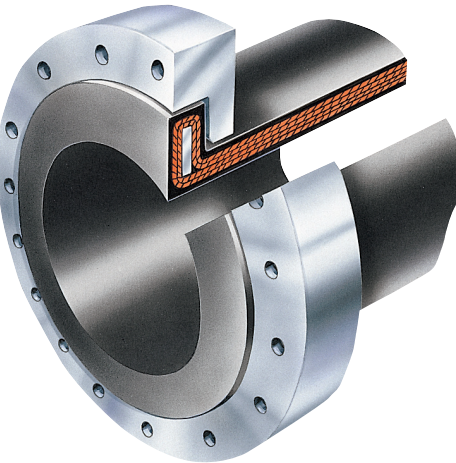

8

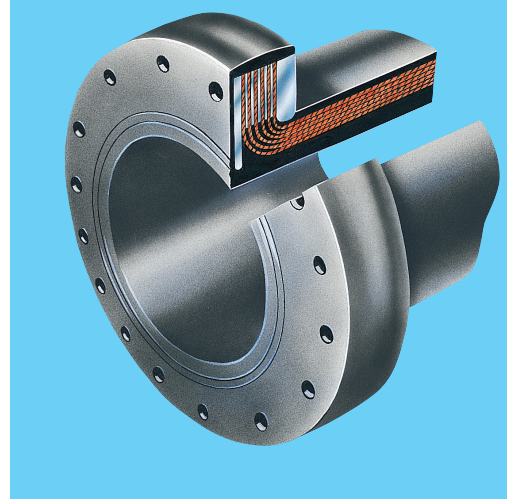

tion tight even at higher axial loads and pressures. It also protects the flange from damage due to raised face flange edges. In many occasions this flange is a cost effective alternative for the Double Action flange or laminated flange.

6 Steel couplings vulcanized in for extreme working conditions

Our solid steel couplings are suitable for heavy and very heavy duty applications. They can be made with the smallest possible pitch circle diameters and are vulcanised into the hose. These couplings are also secured with our safety strap system for extra safety. We use these couplings as standard in our self floating hoses so that you can work during bad weather without the risk of a defective line.

applications where a very short hose is needed with a relative big angle of curvature and high working pressure.

7 Swivel flange

The swivel flange is used with medium service pressures at points where the bolt holes in the mounting flanges are not precisely aligned. The swivel flange simplifies fitting between 2 fixed points.

8 Laminated flange

The laminated flange can be used in circumstances where a relatively high compressive strengths is required and where vulcanized couplings cannot be used. To be used at service pressures of 10 bar and higher axial loads.

Product Specification

Discharge hoses and sleeves

These hoses can be equipped with all the different types of flanges Trelleborg Ridderkerk supplies. They are available in any size, burst pressure up to 150 bar. Liner thickness specified applies to the inside of the hose as well as the flanges. Tricolor wear indicators are optionally available.

Suction hoses and sleeves

The suction hoses can be fitted with all the different types of flanges Trelleborg Ridderkerk supplies. Mostly used

Trelleborg Ridderkerk spring steel spirals absorb these peak loads without the risk of collapsing.

Heavy duty big bore suction hoses come equipped with rigid steel rings. This allows for smooth bending of the hose.

Bucket hose

These hoses, serving as discharge or suction hoses, are able to perform under the worst imaginable conditions.

Used with very sharp materials like coral and caprock, the

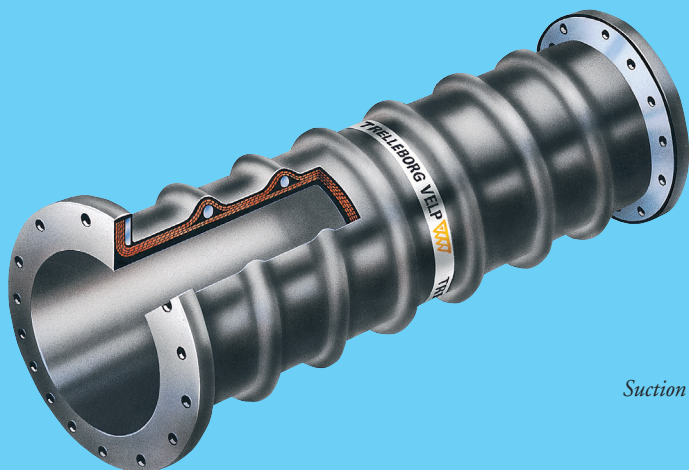

Suction hose



Discharge hose



Pre shaped rubber bend

with these hoses are the rubber flange/steel backing flange and the Double Action flange. They can be supplied in any size, and depending on application, with 100% vacuum capability and high implosion pressures. For use with gimbals and in the ladder of cutter dredgers we can furnish you with small bending radius suction hoses. Trelleborg Ridderkerk has just delivered the suction hoses for the largest trailing suction hopper ever built. In some applications heavy spring steel spirals are used to prevent the hose from kinking. We never use ordinary (thus cheaper) galvanized wire of suction hoses. Ordinary wire cannot cope with the high dynamic loads which occur for example when your suction pipe gets obstructed.

replaceable steel sections provide immunity to cutting while the rubber body allows for bending. Please take notice of the fact that these hoses require provisions to be made to prevent them from being bent beyond the minimum allowable bending radius.

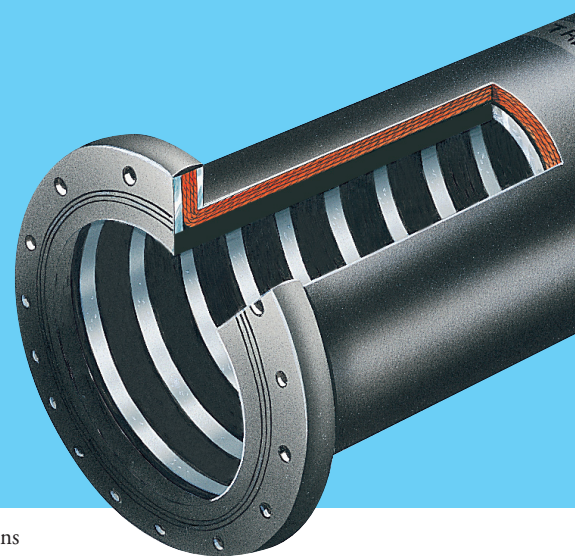

RockTrail®

Driven by the application of trailing suction hopper dredgers in highly abrasive materials and the execution of jobs on sites with sharp edged and coarse solids Trelleborg Ridderkerk has designed the RockTrail range of dredging hoses and flexible joints.

By application of casting- and sintering technology it is now possible to manufacture wear rings with an optimized cross section and a very high Rockwell hardness.

This enables us to manufacture flexible joints with a relatively large steel inner surface and at the same time with the needed flexibility and bending properties.

This patented design makes application of polymer manufactured hoses possible under circumstances and conditions

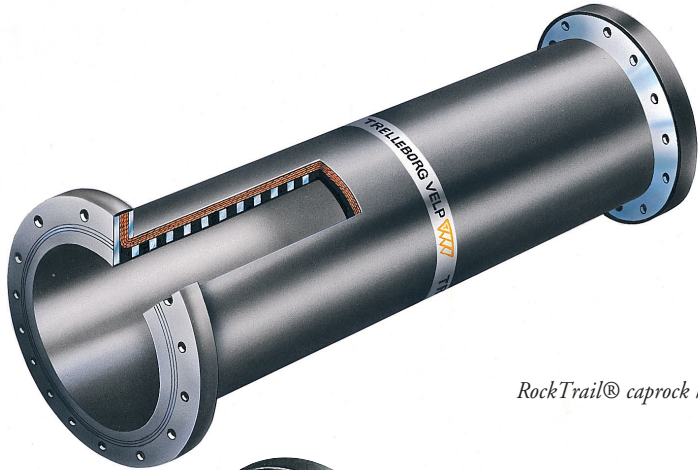

RockTrail® caprock hose

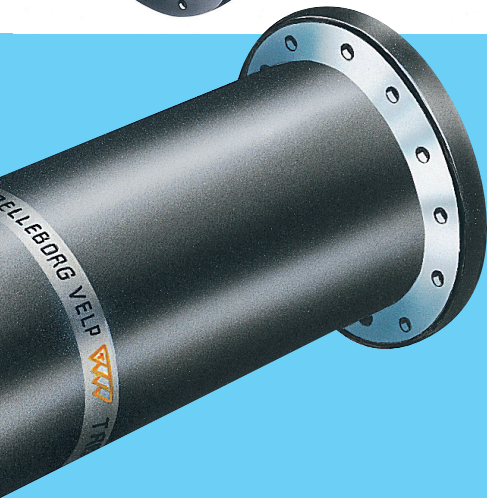

RockTrail®

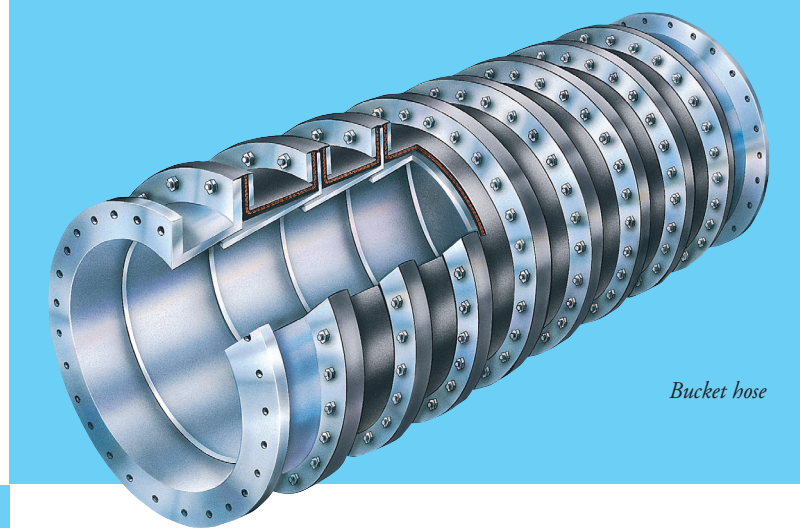

Bucket hose



Expansion piece

where this was not possible in the past.

Besides the use on the large trailers RockTrail suction, suction-discharge hoses and expansion joints are also used on the recently build large rock cutter dredgers.

Compensators and expansion joints

Our compensators, are used in various applications, for example to compensate for big displacements in piping systems or as flexible joints in lines inside ships or process plants.

The compensators can be equipped with all the types of flanges mentioned before.

The rubber used for the inner and outer layers is chosen with full regard to working conditions.

Caprock hose

As a standard supplied with heavy cord layers, this hose offers big advantages when used for transporting sharp materials. Although rubber is a very abrasive resistant material, it has less resistance to cutting. Therefore we vulcanize rings with a rectangular cross section into the hose, preventing the transported material from cutting through the liner.

Selffloating Hose Systems

Trelleborg Ridderkerk floating hose systems have been used on all the major reclamation projects around the world. Driven by the ever increasing demand for longer lifetimes and the fact that floating hoses are used for cutter jobs these days Trelleborg Ridderkerk has redesigned the classic rubber lined floating hose.

Incorporation the same design principle as found in the RockTrail® suction/discharge hoses the latest innovation is the RockFloat® Floating discharge hose. By reducing the

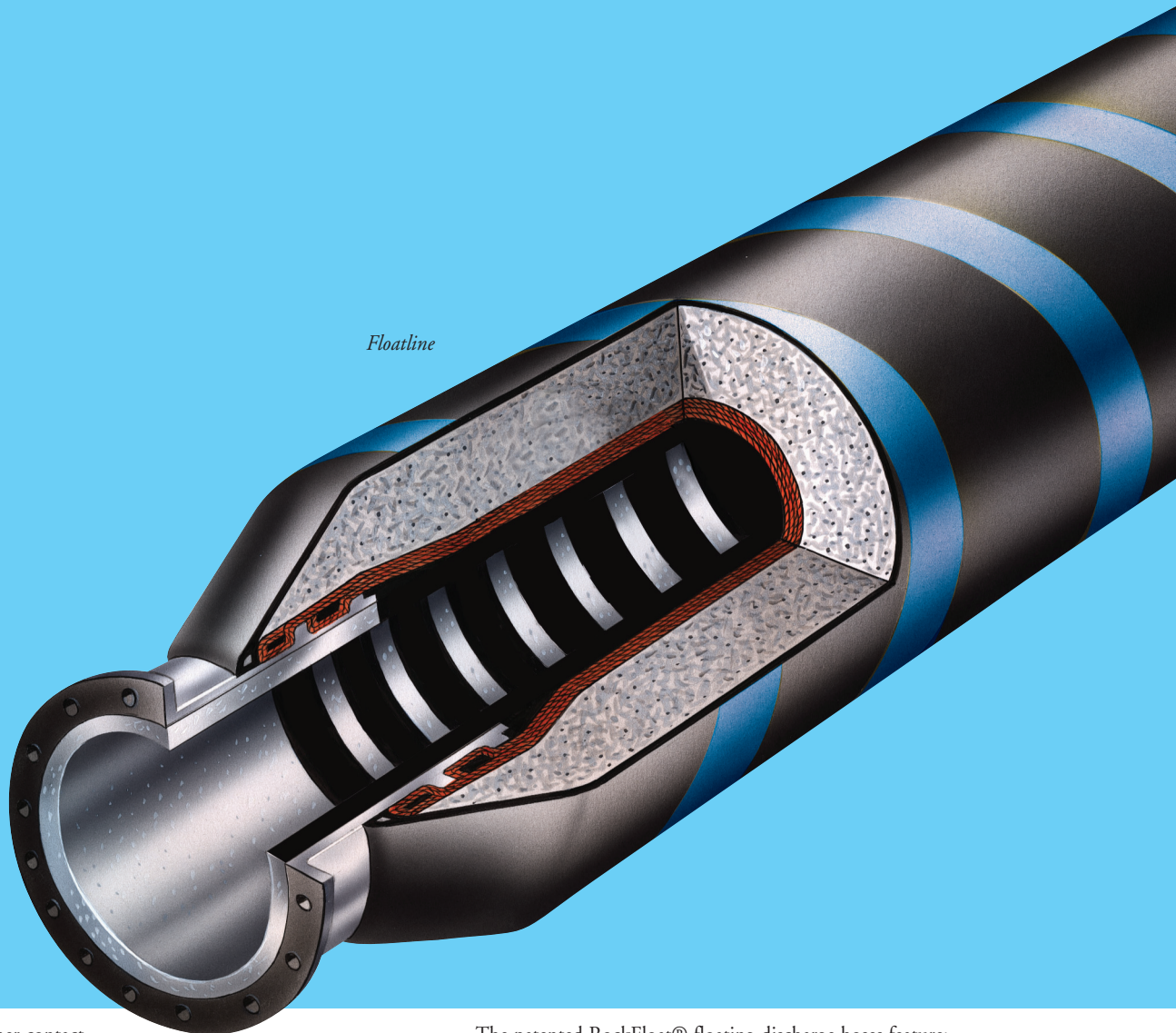

polymer contact surface and adding NiHard4 cast wear rings the RockFloat® hoses show an amazing improvement in lifetime.

It is now possible to use flexible rubber floating hose as a cutter discharge line without the risk of trashing that line within a few weeks of operation.

The patented RockFloat® floating discharge hoses feature:

- 1 Embedded NiHard4 cast rings
- 2 NiHard4 liners in the fittings
- 3 Improved bending characteristics
- 4 Depending on application a lifetime improvement of x 25 compared to the classic rubber lined floating hose
- 5 Applicable for offshore (rock) cutter jobs
- 6 Virtually no wear driven maintenance

These features make the following applications possible:

- Offshore rock cutter discharge applications
- Suitable to convey slurries containing caprock, shell and coral
- Hopper bow connection discharge applications
- Discharge of hopper rip job slurries and sharp edged gravel

For lighter duty applications Trelleborg Ridderkerk supplies a range of standard floating hoses. The Trelleborg Ridderkerk FloatLine discharge hoses feature:

- Extensive use of liner compound with high natural rubber content
- High density foams for very low

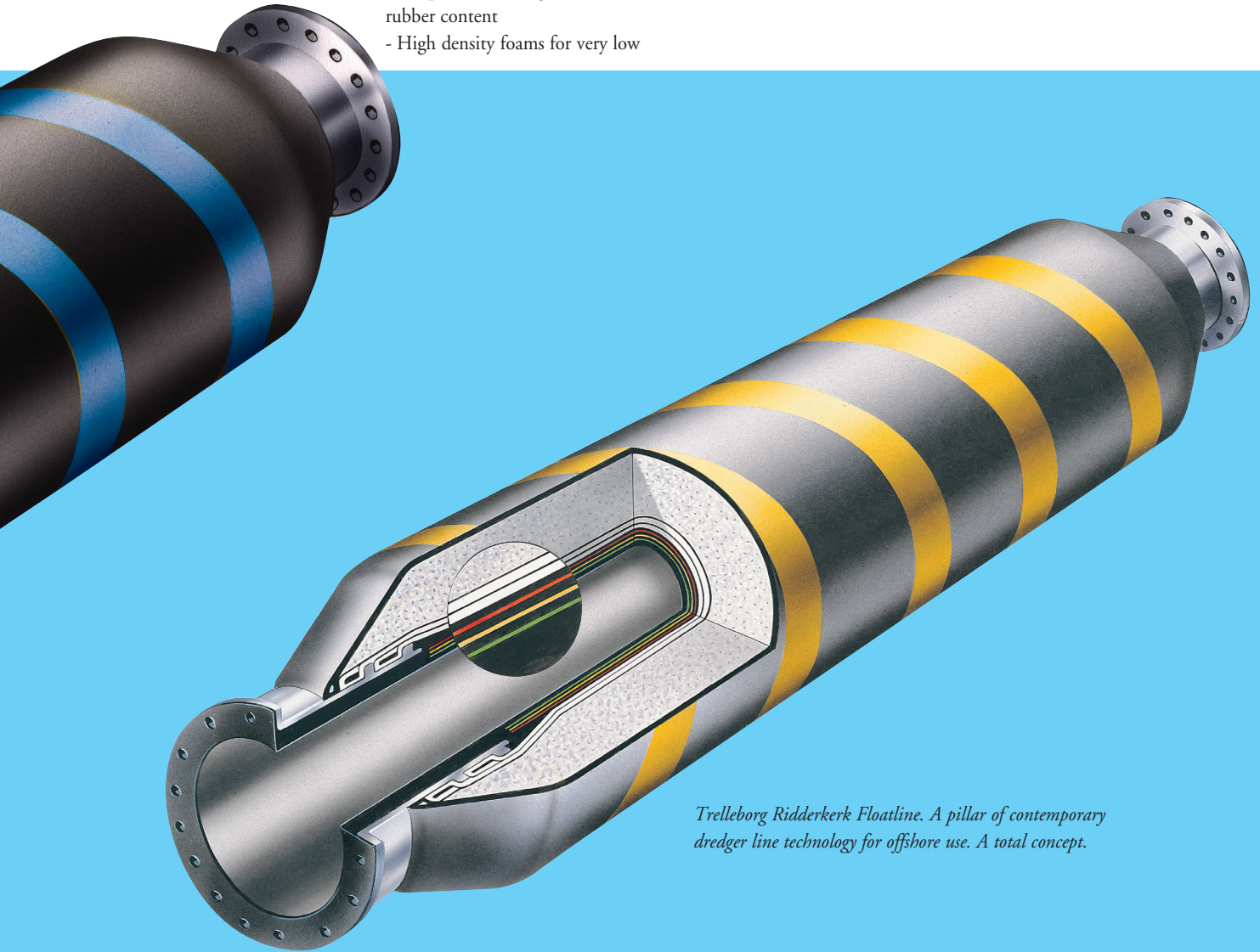

Trelleborg Ridderkerk Floatline. A pillar of contemporary dredger line technology for offshore use. A total concept.

- long term water absorption
- Heavy duty floatation outside cover reinforcement
- The strongest fitting connection in the industry

This makes the FloatLine hose the most economical solution for rubber lined floating hose applications. Obviously tooling for all diameters and lengths are available in order to guarantee you the shortest delivery times.

Production facilities

To guarantee fast and efficient production of our wide product range, we have developed production lines controlled from our design centre. These lines can be set up easily and flexibly. We have a wide range of mandrels, semi-automatic winding machines and a number of different autoclaves for the technical process.

Making a hose starts with the mandrel. Several rubber and cord plies are wound onto the mandrel, depending on the specification. The mandrel plies are then covered with a



layer of rubber. This is done to bond the layers, which is very important for the ultimate strength and flexibility of the hose.

The vulcanization process depends on the product specification. With our autoclaves, this process is controlled by a computer-controlled process controller.

Our quality assurance for rubberizing and processing control in autoclaves is part of an in house quality guarantee system which we have set up for our complete production facility. This is a skilled operator based system. Each stage in hose production is inspected and signed off by the highly skilled operator immediately on completion. Quality control and involvement combined in one system.



1



2



3



4

- 1 **CHARLEMAGNE**
Dredging International, Belgium
- 2 **ORANJE**
Koninklijke Boskalis Westminster, The Netherlands
- 3 **D'ARTAGNAN**
Dredging International, Belgium
- 4 **JUAN SEBASTIÁN DE ELCANO**
Jan de Nul, Belgium

Applications



Suction and jetwater hose in trunnion joint suction pipe ▶

▼ Caprock hose in trunnion joint



▲ Expansion joint in pumphouse



Expansion joint in loading line ▶



◀ Bucket hose in barge loading line cutter dredger

▼ Suction hose in gimble joint suction pipe

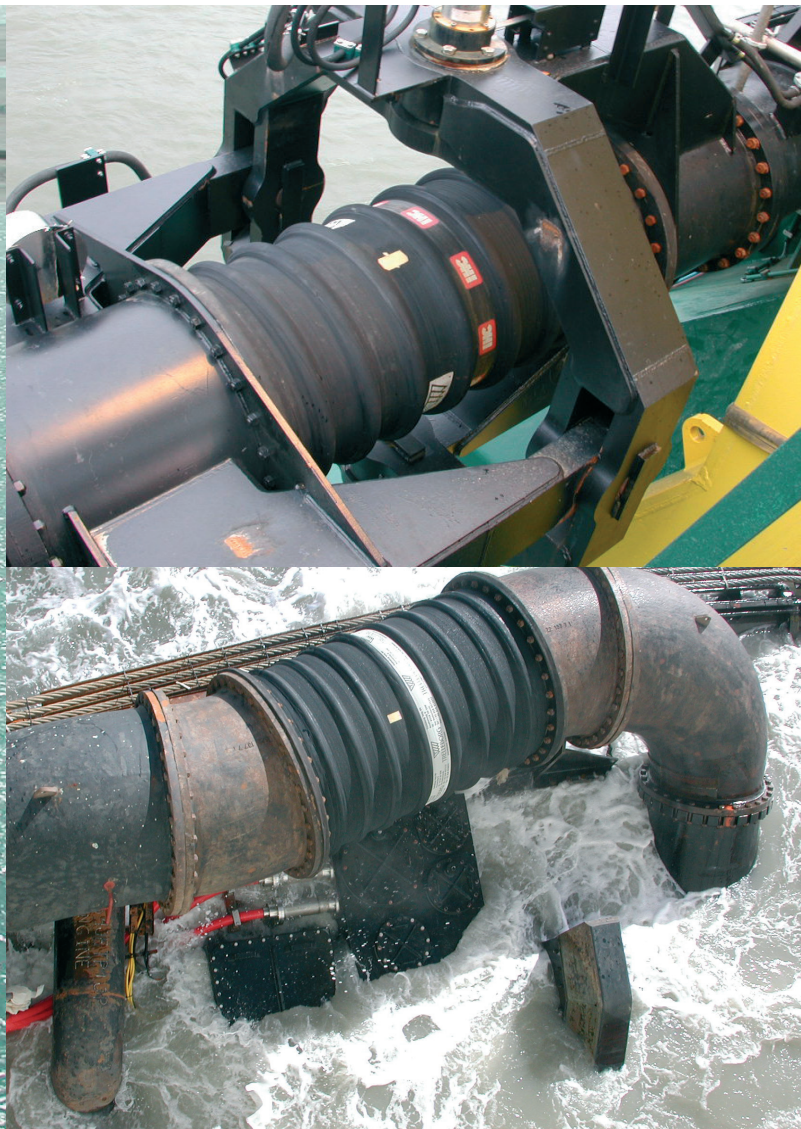

▲ Floating discharge line Palm Island Dubai

▲ Discharge compensator submerged pump



◀ Expansion joint in Y-joint loading line

Applications

▼ *Jetwater hose over gimble joint*
This replaces 3 hoses + 3 bends



▼ *Inspection RockTrail® hose*



▲ *Preshaped rubber elbow in loading line gravel dredger*
Rubber elbow gives a long service life



▲ *Jetwater hose on service frame*



▲ *RockTrail® expansion joint in pumphouse
Replaces a pair of slipflanges
Cures leakage in pumphouse and reduces wear on impeller
and piping*

▼ *Jetwater hoses on drag head*



▲ *Preshaped rubber elbow on dredge pump
Gives long lifetime in abrasive slurries*

▲ *Jetwater hoses on drag head*

TRELLEBORG

Trelleborg Ridderkerk b.v.

Verlengde Kerkweg 15 2985 AZ Ridderkerk the Netherlands

Tel: + 31 (0) 180 49 55 55 Fax : +31 (0)180 43 30 80

E-mail: ridderkerk@trelleborg.com Website: www.trelleborg.com/infrastructure