



Metaxentric Bushes



Metaxentric Bushes

Metaxentric bushes have a large rubber section with the central pin offset towards one radial plane. These bushes can provide a relatively large radial deflection whilst providing excellent motion control characteristics.

The bush has the following features:

- Three dissimilar translational stiffnesses for the best vibration isolation and motion control.
- Load range from 138 - 464 kg
- Rising rate stiffness characteristics for overload conditions help to limit motion and transmitted acceleration.
- Robust and fail-safe, suitable for ROPS and FOPS cab structures.
- Simple to fit, the housing lends itself to robust structures.

Metaxentric Bushes are similar to conventional UD Bushes but with inner and outer sleeves offset radially. This feature provides a greater rubber thickness and hence increased flexibility in the normal direction of loading, whilst maintaining control in other modes and still allowing torsional movement.

The rubber section is relieved to eliminate harmful tensile stresses.

Typical Applications Include:

- Vehicle spring eye mounting
- Tilt Cab pivot bush
- Engine mounting

About Trelleborg Industrial AVS

Over 100 years of experience as Metalastik and Novibra, today Trelleborg Industrial AVS make improvements people can physically feel. From smoother travel to quieter, more efficient machines, we make life feel better. With quality, testing and compliance built in, we're in it for the long haul, ensuring your solution still works, over an extended and often arduous life-cycle.

With three state-of-the-art manufacturing plants across the globe, our experience in rubber to metal bonding enhances several industries, including off-highway vehicles, rail and mass transit, marine and energy and general industry.

We offer an end-to-end service, to take you from concept through design, manufacturing and testing to delivery. This reduces the complexity of supply, helping you cut costs, mitigate risk and receive on time, on budget delivery.

Trelleborg IAVS is part of Trelleborg Group, which employs 15,000 people in over 40 countries. Whatever your challenge, whatever your role and wherever you are, we are nearby to offer expert knowledge and quality solutions.

Metaxentric Bushes

Technical Drawing

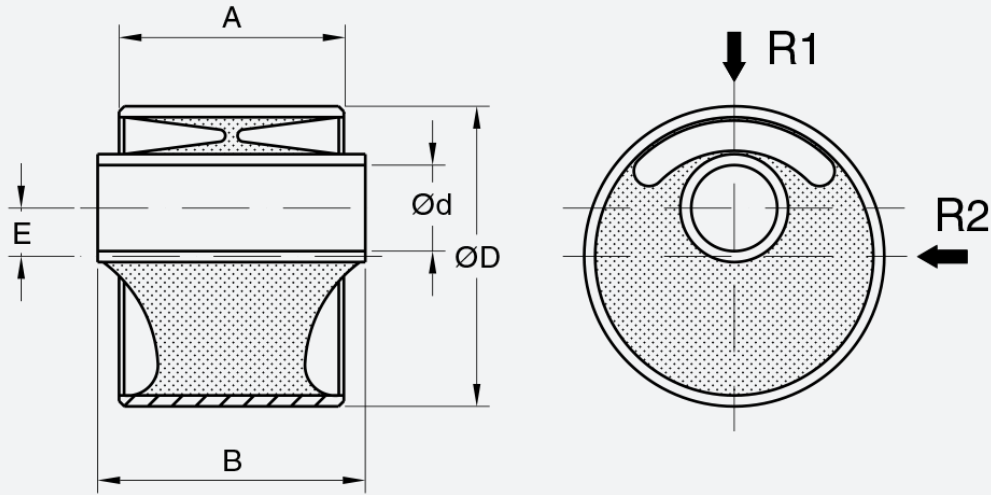

Product Data

DRAWING No.	PART No.	TYPE	DIMENSIONS (mm)					DIRECTION R1			DIRECTION R2	WEIGHT (kg)
			d	D	A	B	E	STIFFN (N/mm)	MAX DEF. (mm)	MAX LOAD (kg)	STIFFN (N/mm)	
13-1270	10-00252	13-1270-50 IRH	16	47.6	50.8	63.5	7.1	675	2	138	1350	0.22
13-1270	10-00253	13-1270-60 IRH	16	47.6	50.8	63.5	7.1	1040	2	212	2080	0.22
13-1270	10-04553	13-1270-70 IRH	16	47.6	50.8	63.5	7.1	1200	2	245	2400	0.22
13-2691	10-00296	13-2691-50 IRH	24	75.3	20.8	70	10.5	750	3.5	268	600	0.56
13-2691	10-00297	13-2691-60 IRH	24	75.3	20.8	70	10.5	1200	3.5	325	910	0.56
13-2691	10-02228	13-2691-70 IRH	24	75.3	20.8	70	10.5	1760	3.5	628	1400	0.56
13-1165	10-00244	13-1165-50 IRH	25.4	88.9	66.7	79.4	14.3	475	3.8	184	640	0.89
13-1165	10-00245	13-1165-65 IRH	25.4	88.9	66.7	79.4	14.3	900	3.8	348	990	0.89
13-1355	10-00262	13-1355-45 IRH	43.7	101.6	63.5	72.4	9.5	682	3.5	243	1150	1.15
13-1355	10-00263	13-1355-60 IRH	43.7	101.6	63.5	72.4	9.5	1300	3.5	464	2200	1.15



WWW.TRELLEBORG.COM/ANTI-VIBRATION-SOLUTIONS

For further information visit our website or e-mail industrialavs@trelleborg.com

The content in this datasheet was correct at the time of printing, but is subject to change without notice.