

# Inflatable Pipe Plugs

Trelleborg Ridderkerk BV





## Table of Contents

- Inflatable Pipe Plugs / Flow Stoppers : OLS	Page 2 and 3
- Pipe Plug with Flexible Bypass: Flex ODS	Page 4 and 5
- Inflatable Bypass Plugs : ODS	Page 6 and 7
- Megaplug ODS	Page 8 and 9
- Flexibele Long Packer: Flex-LP	Page 10
- Accessories	Page 11
- User Manual for Inflatable pipe stopper	Page 12
- Users Manual Megaplug ODS	Page 13 and 14
- Example Factory Test Report	Page 15
- Chemical resistance list Chloroprene- and Nitrile plugs	Page 16

### **Policy quality, environment, safety and health**

The policy of Trelleborg Ridderkerk BV is to design, produce and deliver rubber products which are in accordance with the customers' requests, needs and expectations. The starting point of our policy is the Trelleborg Group policy statement 'Code of Conduct' on our website [www.trelleborg.com](http://www.trelleborg.com).

During the development of products and processes the environment, safety and health are integral to the process. Trelleborg Ridderkerk BV is using an integrated management system which complies to international standards such as ISO 9001, ISO 14001 and SCC\*\*.

### **Quality and Safety**

Because quality and safety are one of the most important aspects in working with pipe plugs we test every plug before delivery at one and a half times the working pressure. This test is performed in the largest pipe diameter for that type. For the strength of the construction we work with a safety margin of at least 3 times the indicated operating pressure on the plug.

The plugs are suitable for testing with air and water according to Euro Norm NEN-EN 1610: Construction and Testing of Drains and Sewers.

We do have the right to change, when necessary, the information in this publication without any notice upfront. For the most up to date information: do contact your supplier. All rights reserved. Nothing from this edition may be copied, saved in an atomized data file, or be published, in any format, without previous notice.

# Inflatable Pipe Plugs / Flow Stoppers: **OLS**

The Inflatable pipe plugs, (Dutch abbreviation OLS) are flow stoppers for temporary close off a range of pipe-diameters. The OLS flow stoppers/plugs are very suitable for use in sewage-systems with inspections, repairs, cleaning but also for pressure testing the drain system according to Euro Norm NEN-EN.

The OLS flow stoppers from the range 70-150 mm are build up with high quality aramide (Kevlar) reinforced layers of neoprene rubber. The plugs are multi-size flow stoppers, this means that with each flow stopper you can close off a range of pipe-diameters. The flow stoppers are easy to install, and as even more important easy and quick removed because of the relative small diameter and light weight.



<b>Type: OLS</b>		<b>40/70*</b>	<b>65/100*</b>	<b>70/150*</b>	<b>100/200-S*</b>	<b>100/200*</b>	<b>150/300*</b>	<b>200/400*</b>	<b>300/600*</b>	<b>500/1000*</b>	<b>500/1200</b>
Range	mm	40-70	65-100	70-150	100-200	100-200	150-300	200-400	300-600	500-1000	500-1200
	inch	1,5-2,7	2,5-4	2,7-6	4-8	4-8	6-12	8-16	12-24	20-40	20-48
Max. workin pressure	Bar	1,5	1,5	1,5	3,0	3,0	3,0	3,0	3,0	3,0	3,0
	PSI	22	22	22	44	44	44	44	44	44	44
Dmin	mm	35	60	65	95	95	135	180	290	460	440
	inch	1,4	2,3	2,6	3,7	3,7	5,3	7,1	11,4	18,1	17,3
Length	mm	160	100	310	250	500	500	500	700	1000	1650
	inch	6,3	4	12,2	9,8	19,7	19,7	19,7	27,6	39,4	65,0
Weight	kg	0,35	0,2	0,55	1,1	2	2,3	4	9	20	52
	LBS	0,8	0,44	1,2	2,4	4,4	5,1	8,8	19,8	44,1	114,6

\*also available in Nitrile.



Type: OLS		40/70		65/100		70/150		100/200 S		100/200		150/300		200/400		300/600		500/1000		500/1200	
		Bar	PSI	Bar	PSI	Bar	PSI	Bar	PSI	Bar	PSI	Bar	PSI	Bar	PSI	Bar	PSI	Bar	PSI	Bar	PSI
Max. working pressure		1,5	22	1,5	22	1,5	22	3,0	44	3,0	44	3,0	44	3,0	44	3,0	44	3,0	44	3,0	44
Pipe diameter		Max. backpressure																			
mm	Inch	Bar	PSI	Bar	PSI	Bar	PSI	Bar	PSI	Bar	PSI	Bar	PSI	Bar	PSI	Bar	PSI	Bar	PSI	Bar	PSI
40	1,5	0,9	13																		
70	2,7	0,7	10	1,1	13	0,9	13														
100	4			0,8	12	0,8	12	2	29	2	29										
150	6					0,7	10	1,3	19	1,6	23	2	29								
180	7							0,7	10	1,4	20	1,7	23								
200	8							0,5	7	1,3	19	1,5	21	2	29						
300	12											1,1	13	1,8	25	2	29				
400	16													1,2	13	1,8	26				
500	20															1,6	23	2	29	1,9	28
600	24															0,9	13	1,9	28	1,9	28
700	27																	1,8	26	1,8	26
800	32																	1,7	23	1,8	26
900	35																	1,1	13	1,7	25
1000	40																	0,5	6	1,7	25
1200	48																			0,8	12

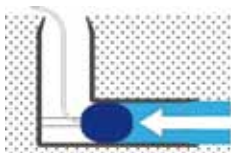

- Above mentioned values are directions in clean and round concrete pipes.
- Maximum backpressure for air testing according to NEN-EN 1610: 200 mbar in all pipe diameters!
- Maximum backpressure for water testing according to NEN-EN 1610: 500 mbar in all pipe diameters!

# Flex ODS:

## Pipe Plug with Flexible Bypass

The Flex-ODS, is a pipe plug with a flexible bypass hose through the stopper and with a diameter of 1", 2" or 4", depending on the size plug. The Flex-ODS plugs are suited to create a diversion or bypass, when working in the pipeline. These plugs are also perfectly suitable for testing with air or water of a pipeline according to Euro Norm NEN-EN-1610: Construction and Testing of drains and sewers.

The Flex-ODS is just like the OLS flow stopper build from high quality aramide (Kevlar) reinforced layers of rubber. Standard the plugs have no Storz coupling mounted, but can also be delivered with a Storz coupling, stainless steel threaded connection of 1", 2" or 4" BSP or NPT.



Type: Flex ODS		100/200	200/400	300/600	500/1000	500/1200
Range	mm	100-200	200-400	300-600	500-1000	500-1200
	inch	4-8	8-16	12-24	20-40	20-48
Backpressure	Bar	2,0	2,0	2,0	2,0	2,0
	PSI	29	29	29	29	29
Dmin	mm	95	180	290	440	440
	inch	3,7	7,1	11,4	17,3	17,3
Length	mm	500	500	700	1350	1650
	inch	19,7	19,7	27,6	53,1	65,0
Weight	kg	3	8	17	52	60
	LBS	6,6	17,6	37,5	114,6	132,3
Optional connection		1" Storz-25D	2" Storz-52C	2" Storz-52C	2" Storz-52C	4" Storz-110A

\*also available in Nitrile.

\*\* Optional Storz-coupling



Type: Flex ODS		100/200		200/400		300/600		500/1000		500/1200	
Max. working pressure		Bar	PSI	Bar	PSI	Bar	PSI	Bar	PSI	Bar	PSI
		2,0	29	2,0	29	2,0	29	2,0	29	2,0	29
Pipe diameter		Max. back pressure									
mm	Inch	Bar	PSI	Bar	PSI	Bar	PSI	Bar	PSI	Bar	PSI
100	4	1,3	19								
150	6	1	14								
200	8	0,7	10	1,3	19						
300	12			1,1	16	1,3	19				
400	16			0,7	10	1,2	17				
500	20					1	14	1,3	19	1,3	19
600	24					0,6	9	1,2	17	1,2	17
700	27							1,1	16	1,1	16
800	32							1,1	16	1,1	16
900	35							1	14	1,1	16
1000	40							0,6	9	1	14
1200	48									0,5	7

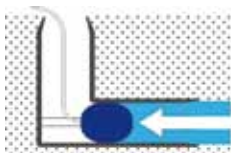

- Above mentioned values are directions in clean and round concrete pipes.
- Maximum backpressure for air testing according to NEN-EN 1610: 200 mbar in all pipe diameters!
- Maximum backpressure for water testing according to NEN-EN 1610: 500 mbar in all pipe diameters!

# ODS:

## Pipe Plug with Bypass mounted on pipe

The Inflatable Bypass Stoppers, abbreviated ODS in Dutch, are pipe plugs with one or more bypass-possibilities depending on size of the plug. The ODS plug consists of a steel core supplied with a reinforced inflatable rubber sleeve. Being inflated the sleeve clamps around the steel core and it sets, fixates itself to the wall of the pipe.

The ODS plug is specially suited for testing with water. The strong sleeve and steel core make higher operating pressures, compare to Flex-ODS, possible and therefore excellent for rough work conditions. The steel core can be used to stamp or strut. Suitable for testing with air and water according to Euro Norm NEN-EN-1610: Construction and testing of drains and sewers.

The rubber sleeve from the ODS plug is build from high quality aramide (Kevlar) reinforced layers of rubber, and can be replaced in case of damage.



Type: ODS		100/200	200/400	300/600	500/1000
	inch	4-8	8-16	12-24	20-40
Max. working pressure	Bar	3,0	3,0	3,0	3,0
	PSI	44	44	44	44
	Dmin	mm	95	195	290
Length	inch	3,7	7,7	11,4	19,3
	mm	360	430	520	1010
Weight	inch	14,2	16,9	20,5	39,8
	kg	4	10	23	90
	LBS	8,8	22,0	50,7	198,4
Connection		2" Storz-52 C	1" Geka 1" Storz-25 D	1" Geka 3" Storz-75 B	1" Geka 2" Storz-52 C 4" Storz-110 A



Type: ODS		100/200		200/400		300/600		500/1000	
Max. working pressure		Bar	PSI	Bar	PSI	Bar	PSI	Bar	PSI
		3,0	44	3,0	44	3,0	44	3,0	44
Pipe diameter		Max. back pressure							
mm	inch	Bar	PSI	Bar	PSI	Bar	PSI	Bar	PSI
100	4	1	14						
150	6	0,8	12						
200	8	0,7	10	1	14				
300	12			0,9	13	1	14		
400	16			0,7	10	0,9	13		
500	20					0,8	12	1	14
600	24					0,5	7	0,9	13
700	27							0,9	13
800	32							0,9	13
900	35							0,8	12
1000	40							0,7	10

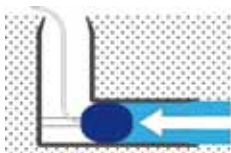

- Above mentioned values are directions in clean and round concrete pipes.
- Maximum backpressure for air testing according to NEN-EN 1610: 200 mbar in all pipe diameters!
- Maximum backpressure for water testing according to NEN-EN 1610: 500 mbar in all pipe diameters!

# MEGAPLUG- ODS

The MEGAPLUG is a special inflatable plug developed for blocking the flow in big pipe diameters larger than 1000 mm. Due to the unique construction, a big range of large diameters pipelines can be closed off with one (1) plug which can be brought into a pipeline through the manhole.

Safe working conditions are of the utmost importance as the power of water can be unpredictably high in big diameter pipelines. Both the quality of the plug as well as the working method, are of the highest importance to create these safe working conditions. For all Megaplugs, a full test report and user manual is being delivered with the plug. The Megaplugs are capable to hold high backpressures because of the large contact surface with the wall and the high operating pressure in the plug.

The Megaplug is standard equipped with a flexible bypass diameter 4", this for testing with air or water and/or to conduct water. For reason of safety all Megaplugs are provided with a safety valve at the plug and a 1" hose with a ball valve, this for a quick and safe deflating after use. Suitable for use according to Euro Norm NEN-EN 1610.



Type: ODS Megaplug		1400	1600	2000	2400
Range	mm	500-1400	700-1600	800-2000	1200-2400
	inch	20-55	27-63	32-80	48-96
Max. working pressure	Bar	1,5	1,0	1,0	1,0
	PSI	22	14	14	14
Dmin	mm	490	580	780	1000
	inch	19,3	22,8	30,7	39,4
Length	mm	2300	2700	3500	4300
	inch	90,6	106,3	137,8	169,3
Weight	kg	95	180	235	***
	LBS	209,4	396,8	518,1	***
Air connection		1"	1"	1"	***
By-pass		4" Storz-110A*	4" Storz-110A*	4" Storz-110A*	***

Bypass diameter 6" and 8" on request.

\*\*\* On request



**Type: ODS Megaplug**                      **1400**                      **1600**                      **2000**                      **2400**

		Bar	PSI	Bar	PSI	Bar	PSI	Bar	PSI
Max. working pressure		1,5	22	1,0	14	1,0	14	1,0	14
Pipe diameter		Max. back pressure with water							
mm	Inch	Bar	PSI	Bar	PSI	Bar	PSI	Bar	PSI
500	20	1,5	22						
600	24	1,3	19						
700	27	1,3	19	1	14				
800	32	1,2	17	0,9	13	0,9	13		
900	35	1,2	17	0,8	12	0,9	13		
1000	40	1,1	16	0,8	12	0,8	12		
1200	48	1,1	16	0,7	10	0,8	12	0,9	13
1400	55	0,8	12	0,7	10	0,7	10	0,9	13
1600	63			0,5	7	0,7	10	0,8	12
1800	71					0,6	9	0,7	10
2000	80					0,5	7	0,6	9
2200	87							0,5	7
2400	96							0,5	7

# Flex-LP:

## Flexibele Long Packers



The Flexible Long Packers, called Flex-LP, are used with a re-lining-method for spot repairs and joint lengths of up to 5 meters. The packers are used for transport and positioning of resin impregnated re-lining base material.

This method makes it possible to repair damaged sewerpipes, without breaking, with new inner layer of resin impregnated base material. The base material generally exist of fibre-reinforced 2 or 3 component epoxy resin.

The Flex-LP Packers are build up with high reinforced layers of rubber, with both sides aluminum ends, a mechanical coupling for air hose, pushing rod and a hoisting eye.

<b>Type: Flex-LP</b>		<b>70-100</b>	<b>70-100</b>	<b>70-100</b>	<b>70-100</b>	<b>70-100</b>	<b>70-100</b>	<b>70-100</b>
Working length	mm	600	1000	1500	2000	3000	4000	5000
	inch	24	39	59	79	118	157	197
Range	mm	70-100	70-100	70-100	70-100	70-100	70-100	70-100
	inch	2,7- 4	2,7- 4	2,7- 4	2,7- 4	2,7- 4	2,7- 4	2,7- 4
Max. working pressure	Bar	3,0	3,0	3,0	3,0	3,0	3,0	3,0
	PSI	44	44	44	44	44	44	44
Dmin.	mm	46	46	46	46	46	46	46
	inch	2,0	2,0	2,0	2,0	2,0	2,0	2,0
Product length	mm	800	1.250	1.700	2.200	3.200	4.200	5.200
	inch	31	49	67	87	126	165	205
Weight	kg	0,6	1,0	1,5	1,8	2,4	3,0	3,6
	LBS	1,3	2,2	3,2	3,9	5,2	6,6	7,9
<b>Type: Flex-LP</b>		<b>100-150</b>	<b>100-150</b>	<b>100-150</b>	<b>100-150</b>	<b>100-150</b>	<b>100-150</b>	<b>100-150</b>
Working length	mm	600	1000	1500	2000	3000	4000	5000
	inch	24	39	59	79	118	157	197
Range	mm	100-150	100-150	100-150	100-150	100-150	100-150	100-150
	inch	4-6	4-6	4-6	4-6	4-6	4-6	4-6
Max. working pressure	Bar	2,5	2,5	2,5	2,5	2,5	2,5	2,5
	PSI	36	36	36	36	36	36	36
Dmin.	mm	64	64	64	64	64	64	64
	inch	2,5	2,5	2,5	2,5	2,5	2,5	2,5
Product length	mm	850	1250	1750	2250	3250	4250	5250
	inch	33	49	69	89	128	167	207
Weight	kg	1,7	2,2	2,6	3,1	4,2	5,4	6,4
	LBS	3,7	4,7	5,7	6,7	9,2	11,8	14,0
<b>Type: Flex-LP</b>		<b>150-200</b>	<b>150-200</b>	<b>150-200</b>	<b>150-200</b>	<b>150-200</b>	<b>150-200</b>	<b>150-200</b>
Working length	mm	600	1000	1500	2000	3000	4000	5000
	inch	24	39	59	79	118	157	197
Range	mm	150-200	150-200	150-200	150-200	150-200	150-200	150-200
	inch	6-8	6-8	6-8	6-8	6-8	6-8	6-8
Max. working pressure	Bar	2,5	2,5	2,5	2,5	2,5	2,5	2,5
	PSI	36	36	36	36	36	36	36
Dmin.	mm	102	102	102	102	102	102	102
	inch	4,0	4,0	4,0	4,0	4,0	4,0	4,0
Product length	mm	880	1280	1780	2280	3280	4280	5280
	inch	34,6	50,4	70,1	89,8	129,1	168,5	207,9
Weight	kg	2,75	3,15	4	4,8	6,15	7,65	9,1
	LBS	6,1	6,9	8,8	10,6	13,5	16,8	20,0



fig 1



fig 2



fig 3



fig 4



fig 5



fig 6



fig 7

fig 1: PU-hose for OLS 40/70 and OLS 65/100 with car tyre valve. L= 2 m.

fig 2: Rubber hose incl. quick release couplings. L= 3, 5 of 10 m.

fig 3: Rubber hose incl. quick release coupling(male), manometer, air release valve and car tyre valve.  
L = 5,5 m.

fig 4: Chain(m.b.b.= 590kg) provided with shackles for handling of little plugs.

For strutting is this chain no option.

fig 5: Pressure operating valve. Equipped with pressure regulator button, pressure gauge, safety valve with air relief option and quick release couplings. The safety valve is set for safe operating pressures just above 3,0 Bar.

fig 6: Car valve adapter.

fig 7: Handpump.

# USER MANUAL FOR INFLATABLE PIPE STOPPER (OLS)

## **Safety Instructions**

### **General**

- Inflate the plug in the pipe to the maximum working pressure but never exceed the max. working pressure.
  - Never exceed the max. allowable back pressure.
  - The OLS may only be used by persons who have been properly instructed and who are familiar with the use of the OLS and the content of the user manual.
  - When using the OLS the safety of the user and any bystanders must always be borne in mind.
  - Do not lift the OLS by the air hose, but attach a rope or chain to the lifting brace intended for the purpose.
  - The OLS is exclusively to be inserted in round pipes.
  - Fill the OLS with air which contains as little oil as possible.
  - ALWAYS connect the OLS according to the instructions listed in the complete user manual.
  - Outside of the pipe the OLS may be inflated to a maximum of 0.5 bar.
- \*Do not exceed maximum allowable pressure differential.  
\*Always connect the OLS according to instructions.

### **Safety measures before use**

- On each occasion, *before* using the OLS, inspect the surface for tears, incisions and any other damage. These can influence the functioning of the OLS. Stoppers which are damaged or which have come into contact with chemical substances may no longer be used. In case of doubt, contact your supplier.
- Avoid sliding of the plug by strutting it or secure it with a suitable chain.
- On each occasion, *before* using the OLS, examine the accessories with which the OLS is to be inflated. Check to ensure that the accessories have been fitted in such a way that they will under no circumstances allow a higher pressure than the maximal operating pressure of the type of OLS in question. The maximal operating pressure of the OLS is indicated on the label.
- Measure the internal diameter of the pipe within which the OLS is to be inserted. Ensure that this dimension is always within the scope of the OLS.
- Before inserting the OLS, clean both the exterior surface of the OLS and the interior surface of the pipe where the OLS is to be positioned. A clean contact surface works to the advantage of a good seal as well as good life span of the OLS.

### **Fitting the OLS**

- Insert the full length of the OLS within the pipe before filling the OLS with air.
- When filling the OLS inside the pipe, only fill the OLS so far that the wall is just touching. Then build up the pressure at a safe distance.
- The maximal operating pressure of the OLS may NEVER be exceeded. The maximal operating pressure of the OLS is indicated on the label. Excessive pressure can cause serious accidents! There are special OLS accessories available, specially designed to prevent the build-up of excessive pressure.
- When using compressed-air cylinders of 200/300 bar a pressure reduction valve must always be fitted. NEVER fill the OLS directly from a compressed-air cylinder.
- \* Check the internal pressure in the OLS regularly. For safety's sake we recommend to keep the OLS connected to air-supply during use to prevent pressure lapse.

### **Connecting the OLS to the air supply system**

#### **Compressed-air system**

Connect the operating valve (with safety valve) to your compressed-air system of max. 10 bar. Then use pipes to connect the operating valve to the OLS. The OLS can now be filled.

Remark: In the case that the air in your compressed-air system contains a high level of oil, oil separators must be used.

#### **Compressor**

Connect the operating valve or tyre valve (with safety valve) to your compressor of max. 10 bar. Then use the pipes supplied by your supplier to connect the operating valve to the OLS. The OLS can now be filled.

#### **Compressed-air cylinder**

To connect the OLS to a compressed-air cylinder of 200/300 bar, follow the instructions listed in the complete version of the user manual.

### **Deflating the OLS**

- Only allow the OLS to empty once you are sure that there is nobody in the pipe system within which the OLS functioned as a seal.
- Empty the OLS at a safe distance in a controlled manner.
- Empty the OLS gradually to slowly reduce the differential pressure.
- Only allow the OLS to empty completely once the pressure differential over the OLS is minimal.
- Do not lift the OLS by the air pipe, but attach a rope or chain to the lifting brace intended for the purpose.
- After use, clean the OLS with soap and water and then leave the OLS to dry at room temperature.

### **Storing the OLS**

The way in which the OLS is stored can considerably influence the life span and operative safety of the OLS.

The ISO 2230 lists the following guidelines:

- Store at a temperature of between +15°C and +25°C.
- Store in dry storage space.
- Screen the OLS from direct (sun)light.
- Screen the OLS from circulating air.
- As far as possible ensure that the OLS is not subject to pressure while stored.
- Avoid long-term contact with liquids during storage.
- Avoid long-term contact with metals during storage.
- Avoid long-term contact with other rubber items.
- After long-term storage the OLS can be cleaned with soap and water. Once cleaned the OLS should be left to dry at room temperature.

### **Repairing the OLS**

In the case of damage to the OLS do not attempt to repair the OLS yourself but contact your supplier.

## USER MANUAL FOR MEGAPLUG

**Attention: Wrong use of the MEGAPLUG can cause life threatening situations! Always follow these Safety Instructions. The manufacturer is not liable for damage to persons or objects caused by wrong use of the MEGAPLUG.**

### General

- Inflate the Megaplu in the pipe to the maximum working pressure but never exceed the max. working pressure.
- Never exceed the max. allowable back pressure.
- The MEGAPLUG may only be used by persons who have been properly instructed and who are familiar with the use of the MEGAPLUG and the content of the user manual.
- When using the MEGAPLUG the safety of the user and any bystanders must always be borne in mind.
- Do not lift the MEGAPLUG by the air hose, but attach a rope or chain to the lifting brace intended for the purpose.
- The MEGAPLUG is exclusively to be inserted in round pipes.
- Fill the MEGAPLUG with air which contains no oil.
- ALWAYS connect the MEGAPLUG according to the instructions listed in the user manual.
- Outside of the pipe the MEGAPLUG may be inflated to a maximum of 0.2 bar.
- Always try to strut the MEGAPLUG to avoid sliding.

### Safety measures before use

- On each occasion, *before* using the MEGAPLUG, inspect the surface for tears, incisions and any other damage. These can influence the functioning of the MEGAPLUG. Stoppers which are damaged or which have come into contact with chemical substances may no longer be used. In case of doubt, contact your supplier.
- On each occasion, *before* using the MEGAPLUG, examine the accessories with which the MEGAPLUG is to be inflated. Check to ensure that the accessories have been fitted in such a way that they will under no circumstances allow a higher pressure than the maximal operating pressure of the type of MEGAPLUG in question. The maximal operating pressure of the MEGAPLUG is indicated on the label. Make sure that the safety valve is clean.
- Measure the internal diameter of the pipe within which the MEGAPLUG is to be inserted. Ensure that this dimension is always within the scope of the MEGAPLUG.
- Before inserting the MEGAPLUG, clean both the exterior surface of the MEGAPLUG and the interior surface of the pipe where the MEGAPLUG is to be positioned. A clean contact surface works to the advantage of a good seal as well as good life span of the MEGAPLUG.

### Fitting the MEGAPLUG

- Insert the full length of the MEGAPLUG within the pipe before filling the MEGAPLUG with air.
- When filling the MEGAPLUG inside the pipe, only fill the MEGAPLUG so far that the wall is just touching. Then build up the pressure at a safe distance. Do this only from outside the pipe-system. Make sure that nobody is in the pipe-system during the filling period!
- **Watch: when this advice is not being followed, heavy accidents can occur.**
- The maximal operating pressure of the MEGAPLUG may NEVER be exceeded. The maximal operating pressure of the MEGAPLUG is indicated on the label. Excessive pressure can cause serious accidents! There are special MEGAPLUG accessories available, specially designed to prevent the build-up of excessive pressure.
- Check the internal pressure in the MEGAPLUG regularly. For safety's sake we recommend to keep the MEGAPLUG connected to air-supply during use to prevent pressure lapse.
- Always use strutting when using the plug, to prevent the MEGAPLUG from sliding out. Strutting methods are indicated on picture 1 and 2.

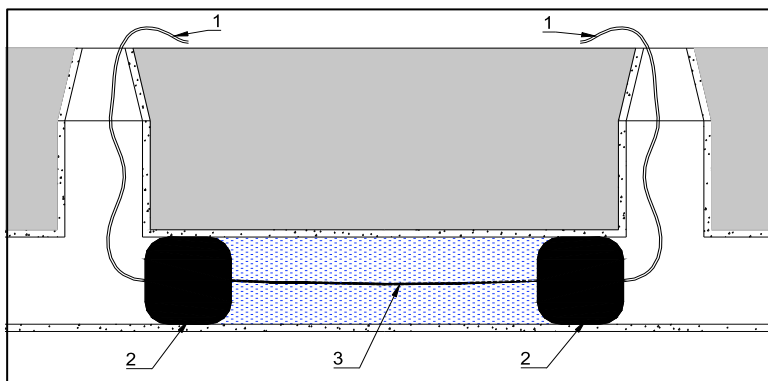

Picture 1: Strutting with steel chain

1. Air supply hose
2. Megaplug
3. Steel chain with sufficient strength!!

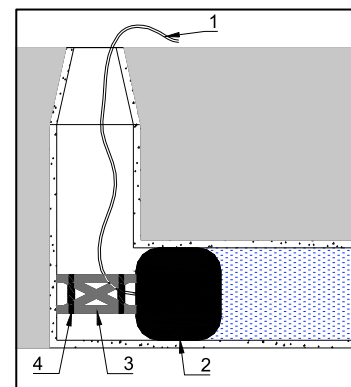

Picture 2: Strutting-construction.

1. Air supply hose
2. Megaplug
3. Strutting construction with wooden beams.
4. Connections

**Connecting the MEGAPLUG to the air supply system**

- Always fill the MEGAPLUG with an operating valve with pressure gauge that indicates the pressure within the plug. The MEGAPLUG is supplied with a safety valve regulated on 1,5 bar. Please note that this safety valve has limited capacity. Fill the MEGAPLUG with a supply pressure close to 1,5 bar.
- When using compressed-air cylinders of 200/300 bar a pressure reduction valve must always be fitted. **NEVER** fill the OLS directly from a compressed-air cylinder.

**Deflating the MEGAPLUG**

- Only allow the MEGAPLUG to empty once you are sure that there is nobody in the pipe system within which the MEGAPLUG functioned as a seal.
- Empty the MEGAPLUG at a safe distance in a controlled manner. To speed up the deflating process the 2" Air vent with a hose attached to it can be used.
- Empty the MEGAPLUG gradually to slowly reduce the differential pressure.
- Only allow the MEGAPLUG to empty completely once the pressure differential over the MEGAPLUG is minimal.
- **When performing a test with water it is absolutely necessary to reduce the backpressure by pumping away water, before deflating the MEGAPLUG . Otherwise the plug will slide out due to the weight of the water!!!**
- After use, clean the MEGAPLUG with soap and water and then leave the MEGAPLUG to dry at room temperature.

**Storing the MEGAPLUG**

The way in which the MEGAPLUG is stored can considerably influence the life span and operative safety of the MEGAPLUG. The ISO 2230 lists the following guidelines:

- Store at a temperature of between +15°C and +25°C.
- Store in dry storage space.
- Screen the MEGAPLUG from direct (sun)light and circulating air.
- As far as possible ensure that the MEGAPLUG is not subject to pressure while stored.
- Avoid long-term contact with liquids, metals and other rubber items during storage.
- After long-term storage the MEGAPLUG can be cleaned with soap and water. Once cleaned the MEGAPLUG should be left to dry at room temperature.

**Repairing the MEGAPLUG**

In the case of damage to the MEGAPLUG do not attempt to repair the MEGAPLUG yourself but contact your supplier.

This User Manual was delivered with Megaplug no..... d.d. .... to the customer or end-user and explained where necessary.









Please return by fax the completed form after reading this manual, and sent it to:

**Trelleborg Ridderkerk BV. Fax no.: +31 180 433080**  
Attn. of Sales Department

.....  
Supplier

.....  
Customer/End-user

## Example Test Certificate

<b>Fabriekscontrole-attest</b> <b>NEN-EN 10204 2.2</b>	<b>Factory test report</b>									
<b>Werkzeugnis</b>	<b>Certificat de controle</b>									
<b>Product: Opblaasbare afsluiter</b> <b>Produkt: Rohrblase</b>	<b>Product: Inflatable pipeplug</b> <b>Produit : Bouchon gonflable tuyaux</b>									
<div style="border: 2px solid black; padding: 10px; background-color: yellow; margin: 0 auto; width: 80%;">  <span style="font-size: 2em; font-weight: bold; color: red;">Flex-ODS</span> <div style="border: 1px solid black; width: 150px; height: 20px; display: inline-block; margin-left: 10px;"></div> </div> <div style="margin-top: 10px;"> <table style="width: 100%; border: none;"> <tr> <td style="width: 50%;">Product no. / Product no. Produkt no. / No. de Produit</td> <td style="width: 50%; text-align: right;">:</td> <td style="border: 1px solid black; width: 200px; height: 25px;"></td> </tr> <tr> <td>Maximale werkdruk / Maximum working pressure Maximaler Betriebsdruck / Pression de travail maxi</td> <td style="text-align: right;">:</td> <td>2,0 Bar 29 Psi</td> </tr> <tr> <td>Veilighheidsfaktor / Safety factor Sicherheitsfaktor / Facteur de sécurité</td> <td style="text-align: right;">:</td> <td>min. 3 x werkdruk / min. 3 x working pressure min. 3 x Betriebsdruck / min. 3 x pression de travail</td> </tr> </table> </div> <div style="text-align: center; margin-top: 10px;">  <span style="font-size: 1.2em; color: red; font-weight: bold;">!</span> <span style="margin: 0 10px;"> <b>Volg instructies voor gebruik.</b>  <b>Follow instructions before use.</b>  <b>Beachten Sie die Gebrauchsanweisungen.</b>  <b>Suivre les instructions avant l'utilisation.</b> </span> <span style="font-size: 1.2em; color: red; font-weight: bold;">!</span>  </div> <div style="display: flex; justify-content: space-around; align-items: center; margin-top: 10px;"> <div style="text-align: center;">   <b>Kevlar<sup>®</sup> reinforced</b> </div> <div style="text-align: center;">  </div> <div style="text-align: center;">  </div> <div style="text-align: center;">  </div> <div style="text-align: center;">  </div> <div style="text-align: center; margin-right: 20px;">  </div> </div>		Product no. / Product no. Produkt no. / No. de Produit	:		Maximale werkdruk / Maximum working pressure Maximaler Betriebsdruck / Pression de travail maxi	:	2,0 Bar 29 Psi	Veilighheidsfaktor / Safety factor Sicherheitsfaktor / Facteur de sécurité	:	min. 3 x werkdruk / min. 3 x working pressure min. 3 x Betriebsdruck / min. 3 x pression de travail
Product no. / Product no. Produkt no. / No. de Produit	:									
Maximale werkdruk / Maximum working pressure Maximaler Betriebsdruck / Pression de travail maxi	:	2,0 Bar 29 Psi								
Veilighheidsfaktor / Safety factor Sicherheitsfaktor / Facteur de sécurité	:	min. 3 x werkdruk / min. 3 x working pressure min. 3 x Betriebsdruck / min. 3 x pression de travail								
<p>Met dit certificaat wordt verklaard dat dit product is geproduceerd, geïnspecteerd en getest overeenkomstig bovengenoemde specificaties.</p> <p>This certificate states that the above product is produced, inspected and tested according to above mentioned specifications.</p> <p>Mit dieses Zertifikat erklären wir daß dieses Produkt ist produziert, inspiziert und geprüft gemäß obengenannte Spezifikation.</p> <p>Nous déclarons que ce produit a été contrôlé et reconnu conforme aux spécification ci-dessus.</p>										
<b>TRELLEBORG RIDDERKERK B.V.</b>										
Signature : Naam / name : Name / Nom	Datum / Date: Datum / Date									

## Chemical resistance plugs with Chloroprene and NBR cover

	Resistance	
	CR	NBR
Allyl chloride	--	--
Acetone	--	--
Alcohol	++	++
Aluminium chloride	+/-	++
Chlorure d'aluminium	++	+/-
Aluminium nitrate	++	++
Aluminium sulphate	++	++
Anilin	--	--
Acetic acid 50%	--	--
Acetic acid 100%	--	--
Benzol(Benzene)	--	--
Petrol Ether	--	--
Bromine	--	--
Butanol	++	++
Calcium chloride	++	++
Calcium Hydroxide	++	++
Calcium Nitrate	++	++
Ether	--	--
Ethylglycol	++	++
Gasoil	+/-	++
Glycerin	++	++
Hexanol	+/-	++
Potassium carbonate	++	++
Potassium hydroxide 50%	+/-	+/-
Potassium nitrate	++	++
Potassium sulphate	++	+/-
Kerosene	--	--
Magnesium chloride	++	++
Hydroxyde de magnésium	++	+/-
Mineral petrol	--	+/-
Sodium carbonate	++	++
Sodium chlorite	++	++
Sodium hydroxide 25%	++	++
Sodium sulphate	++	+/-
Petroleum crude oil	--	+/-
Nitric acid 20%	--	--
Nitric acid 70%	--	--
Fatty acid	+/-	--
Distilled water	+/-	++
Sea water	++	++
Zinc chloride	++	++
Zinc nitrate	++	++
Zinc sulphate	++	++
Hydrochloric Acid 10%	--	+/-
Hydrochloric Acid 37%	--	+/-
Sulphuric acid 20%	+/-	+/-

-- = Not recommended  
 +/- = Moderate  
 ++ = Good

**REMARK:**

1. THE CHEMICAL RESISTANCE OF THE OLS IS ALSO DEPENDENT UPON THE CONCENTRATION, DURATION OF CONTACT AND THE TEMPERATURE AT THE TIME USE.
2. THE CHEMICAL RESISTANCE OF THE OLS TO OTHER SUBSTANCES CAN BE ASSESSED UPON REQUEST.
3. THE CHEMICAL RESISTANCE OF THE OLS ARE VALID AT 18 DEGREES CELCIUS



## Policy quality, environment, safety and health

The policy of Trelleborg Ridderkerk BV is to design, produce and deliver rubber products which are in accordance with the customers' requests, needs and expectations.

The starting point of our policy is the Trelleborg Group policy statement 'Code of Conduct' on our website [www.trelleborg.com](http://www.trelleborg.com).

During the development of products and processes the environment, safety and health are integral to the process.

Trelleborg Ridderkerk BV is using an integrated management system which complies to international standards such as ISO 9001, ISO 14001 and SCC\*\*.



# TRELLEBORG

Trelleborg Ridderkerk BV  
Verlengde Kerkweg 15 2985 AZ Ridderkerk  
P.O. Box 4007 2980 GA Ridderkerk The Netherlands.  
Phone: +31 180 49 55 55 Fax: +31 180 43 30 80 Email: [ridderkerk@trelleborg.com](mailto:ridderkerk@trelleborg.com)  
[www.Trelleborg.com/infrastructure](http://www.Trelleborg.com/infrastructure)