

# Trelleborg 603 Power-Lock IPS

Integrated sealing system for plastic pressure pipes

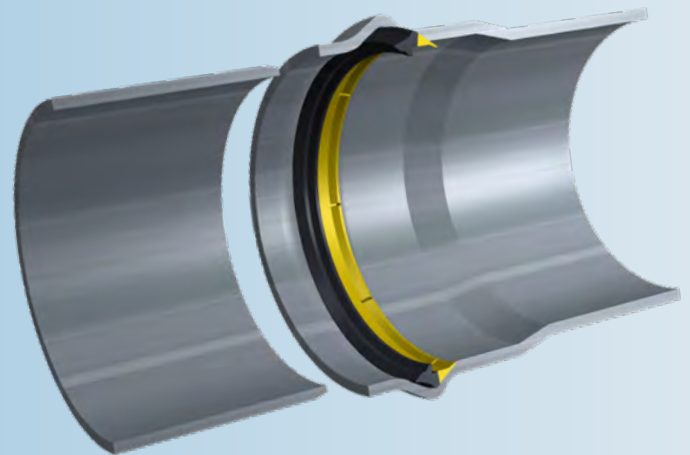

## KEY FEATURES AND BENEFITS

- Greater joint reliability due to joint tolerance reduction
- Fully automated insertion eliminates risk of human error
- Low jointing force, eliminating risk of seal displacement

## SEAL DESIGN AND FUNCTION

Trelleborg 603 Power-Lock IPS is integrated into the pipe during the manufacturing process. By heating the pipe and using the mandrel together with the seal as a tool to form the socket, the seal is effectively shaping its own groove. This reduces irregularities and tolerances in the socket.

The seal is equally effective under positive and negative pipe pressure (vacuum). Under positive pressure, the higher the pressure the greater the sealing force. Under vacuum, the seal maintains a positive sealing force against spigot and socket, preventing sand or soil to enter the joint.

The Trelleborg 603 Power-Lock IPS is a composite seal consisting of:

1. A flexible rubber element to seal effectively against spigot and socket
2. A polypropylene reinforcement element, which holds the seal firmly in place

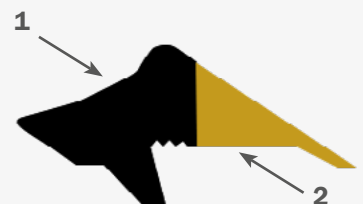

## JOINT ASSEMBLY

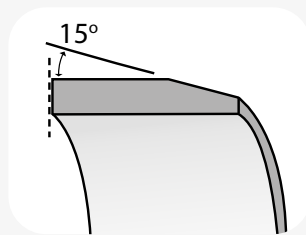

Inspect the spigot, socket and seal for damage and remove any dirt or dust prior to assembly. Chamfer the spigot end and remove all burrs.

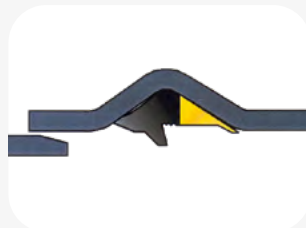

Apply lubricant to the spigot end and immediately bring it into contact with the socket.

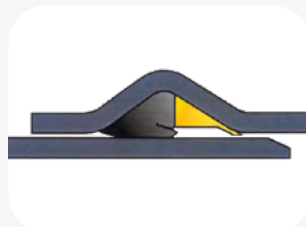

Align spigot and socket, and slide the spigot into the pipe, past the seal.

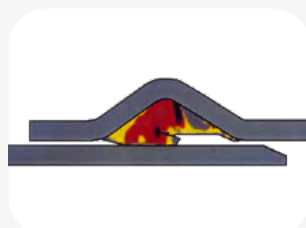

As the pipes are joined the rubber sealing element is deformed and creates pressure against both spigot and socket resulting in a watertight seal.

## STANDARDS

- NSF / ANSI 14
- NSF / ANSI 61
- ASTM F477
- ASTM 2241
- NMX T-021
- NOM-001-CONAGUA

## SIZE CHART

PIPE SIZE (mm)	A (mm)	B (mm)
2	0.314	0.673
2.5	0.433	0.944
3	0.472	1.011
4	0.512	1.098
5	0.551	1.260
6	0.590	1.271
8	0.669	1.460
10	0.787	1.716
12	0.866	1.889

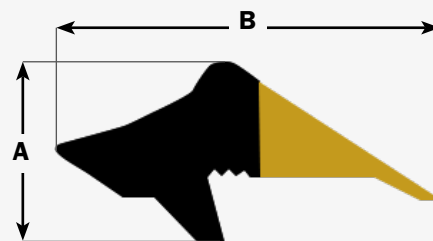
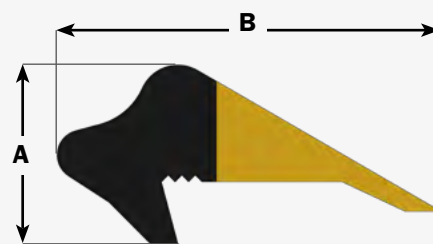

## MATERIAL

- Synthetic rubber (EPDM)
- Hardness 50+/-5 IRHD
- Ozone resistant
- Reinforced retaining ring

Trelleborg proven quality:



CLASSIFIED  
UL  
WATER QUALITY



TRELLEBORG

WWW.TRELLEBORG.COM/EN/SEALS-AND-PROFILES/