



Sealing Solutions for Fluid Power Applications



Your Partner for Sealing Technology

ENSURING LONG-LASTING, RELIABLE OPERATION IN HARSH CONDITIONS

Fluid power components perform critical functions and are used in a wide range of equipment, from tractors, excavators and other off-highway equipment to manufacturing machines, such as injection molding machines and presses. Components and seals must be reliable, long-lasting and capable of operating in harsh and demanding conditions.

Fluid power applications are challenging for seals. Not only must the hydraulic seals prevent leakage, but seals must also withstand high pressures, extreme high and low temperatures, as well as transverse forces within the cylinder.











Trelleborg Sealing Solutions offers a broad range of sealing solutions for fluid power components. Our experts and IFPS certified hydraulic specialists, partner with customers to develop, manufacture and supply seals to meet unique needs.

Stand up
to the harshest and most demanding of conditions

Sealing expertise
accelerates the time to market

Global engineering experts
partner with you to develop the optimum sealing solution and **increase the performance** of your application

SELECTED TOOLS FOR DESIGN ENGINEERS

Mechanical Design Assistance	Standards, Conversions and Norms	Learning and Knowledge	Product Selection
 Hydraulic System Calculator  Area & Volume Calculator  Mechanical Engineering Calculator  Fluid Mechanics Calculator  CAD Services	 ISO Fits & Tolerances  Unit & Hardness Converter	 Installation Instructions  e-Learning on Sealing Technology	 Electronic Catalog  Sealing Solutions Configurator

● Website Tools & Services

● Mobile Apps

Further Information

To find our complete range of tools and apps for engineers, visit www.tss.trelleborg.com or scan the QR code.



Technical Library

Technical articles, whitepapers and webinars can be found in the Technical Library at www.tss.trelleborg.com.

Unrivaled Services & Capabilities

Trelleborg Sealing Solutions contributes more benefits than a simple seal supplier. Our experts partner with customers across the globe to help them achieve their goals, whether starting from a "black box" specification, aiding testing and qualification to get product to market, or developing solutions to enhance manufacturing and supply chain processes.



ServicePLUS

- Services to support every step of your value chain:
- Optimize product & application performance
- Maximize production throughput
- Enhance supply chain processes
- Boost customer care



ENGINEERING

- State-of-the-art CAD tools
- Experienced designers
- On-site support at customer facilities
- Dedicated project management
- FEA modeling
- Prototyping
- Custom-made solutions



TESTING

- Nine research and development centers globally
- World class material & product testing equipment
- Analytical laboratories



PROJECT MANAGEMENT & QUALIFICATION

- Comprehensive project management
- From development to serial production and product introduction

Sealing Solutions for Hydraulic Cylinders

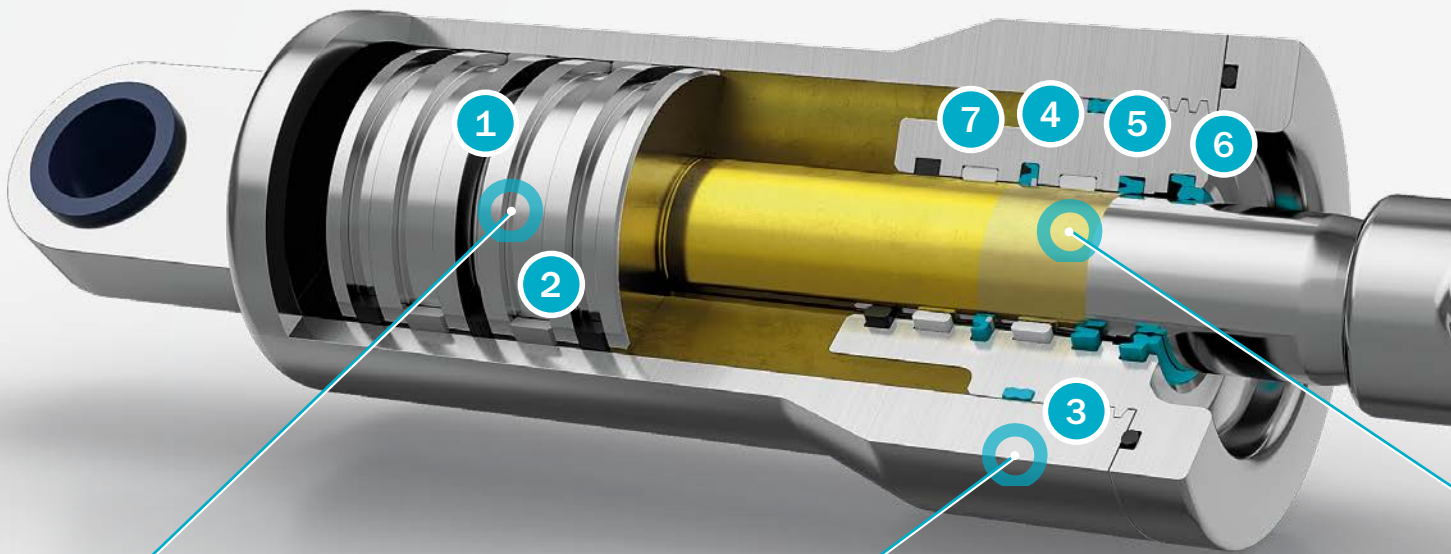

PISTON

Fluid needs to be inhibited from flowing across internal components.

- 1 **Piston Seal:** Zurcon® Wynseal, Zurcon® Glyd Ring® D, or Turcon® Glyd Ring® T
- 2 **Wear Rings:** Slydring® available in Orkot®, HiMod® and Turcite®



Orkot® Slydring®

Made of a resin-impregnated fine-weave fabric material with added lubricants, this wear ring prevents metal-to-metal contact in hydraulic cylinders and is capable of withstanding high loads.

HOUSING

Fluid must be contained within the hydraulic system and environmental contamination prevented.

- 3 **Static Seals:** Dualseal, O-Ring and Back-up Ring



Zurcon® Dualseal

Recommended for heavy duty applications, this single seal element is for static applications. It offers resistance to twisting, easy installation and long service.



ROD

Leakage of fluid from within the cylinder to the outside needs to be stopped as does ingress of external contamination. Transverse forces should be absorbed and metal-to-metal contact avoided.

- 4 **Primary Rod Seal:** Zurcon® Buffer Seal LM, Turcon® Stepseal® V LM
- 5 **Secondary Rod Seal:** Zurcon® U-Cup RU9, Zurcon® Rimseal
- 6 **Scraper:** Zurcon® Scraper DA22, Zurcon® Scraper DA24
- 7 **Wear Rings:** Slydring® available in Orkot®, HiMod® and Turcite®



Zurcon® Buffer Seal LM (Lubrication Management)

This innovative design incorporates large radius rounded edges on the seal and Back-up Ring that lower contact pressure, allowing a thicker amount of fluid to lubricate and activate the secondary seal.

LEADING TECHNOLOGY

Continuing to innovate in sealing of hydraulics, Trelleborg Sealing Solutions optimizes system performance.

LUBRICATION MANAGEMENT TECHNOLOGY

Effective sealing in demanding hydraulic applications requires seals and lubricants to work together. Trelleborg's Lubrication Management technology transforms hydraulic sealing by adjusting lubrication conditions of all single sealing elements within a sealing system.

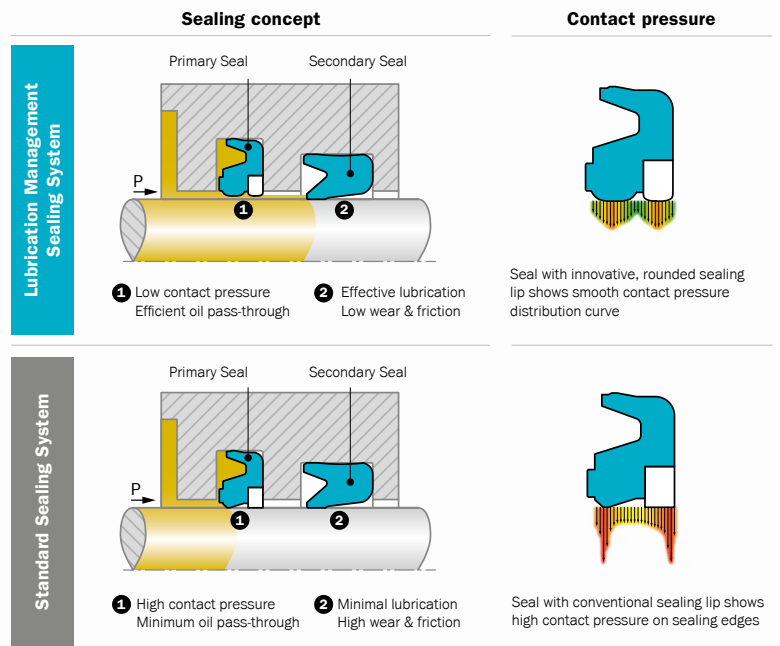

COUNTER SURFACES

Surface competence ensures that the performance requirements for hydraulic applications are met. Trelleborg Sealing Solutions is an expert in this area, which is managed by a Global Surface Competence Team. Devoting a high level of R&D into the analysis of surfaces, counter surfaces and lubrication, we can advise on the optimum surface coatings and finishes.

MATERIAL & DESIGN COMPETENCE

As a pioneer in the development of specialist seals for fluid power applications, the Trelleborg Sealing Solutions range includes many innovative and unique sealing elements specifically engineered for fluid power systems. Encompassing advanced principles such as back-pumping and Lubrication Management, we work in collaboration with our customers to develop sealing configurations that exceed performance requirements.

Based on decades of research and test results, our experts and IFPS certified hydraulic specialists, partner with customers to recommend the optimum solution in terms of design and material compound for any application.

Sealing Solutions for Pumps

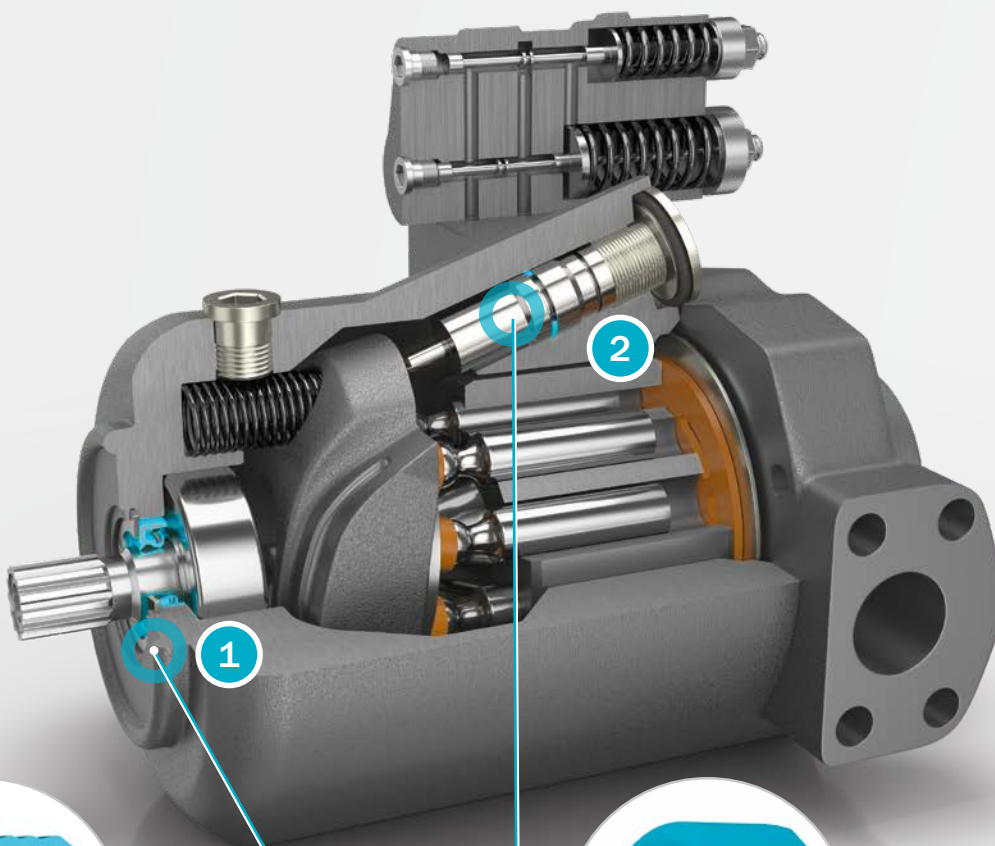

DRIVE SHAFT

The external drive shaft of an axial piston pump provides the rotational force needed to drive the pump. Given the environment these pumps often operate in, leakage is not acceptable.

- 1 **Radial Oil Seal:** Prevents leakage from the drive shaft during pump operating cycles and excludes ingress of contamination with an externally facing dustlip.

POSITIONING PISTON

The swashplate angle in a variable displacement axial piston pump is adjusted by a positioning piston. As the flow rate of the pump is determined by this angle, it is critical that the position is precisely controlled.

- 2 **Turcon® Glyd Ring® :** A low friction, abrasion resistant seal that allows the positioning cylinder to function reliably as needed over a long period of time.

MATERIALS

Trelleborg Sealing Solutions has developed an industry-leading group of materials within each material type. Fluid power component manufacturers can select the compound that best suits their needs.

ADVANCED ELASTOMER MATERIALS

NBR (Nitrile Butadiene Rubber)

NBR is primarily used with mineral-based oils and greases and in general the material has good mechanical characteristics.
Operating temperatures: -30 °C to +100 °C / -22° F to +212 °F

HNBR (Hydrogenated Nitrile Butadiene Rubber)

HNBR is often used in high-temperature applications due to its excellent abrasion resistance and good mechanical properties.
Operating temperatures: -30 °C to +140 °C / -22 °F to +284 °F

FKM (Fluorocarbon Rubber)

FKM is known in particular for its very good resistance to fuel, oil and aggressive media, as well as excellent resistance to ozone, weathering and aging. Depending on structure, fluorine content and curing system, FKM materials can differ in their chemical resistance and cold-flexibility.
Operating temperatures: -20 °C to +200 °C / -4 °F to +392 °F, for short periods up to +230 °C /+446 °F

TURCON® – Outstanding Friction Characteristics

Turcon® is the Trelleborg Sealing Solutions range of proprietary materials based on premium-grade Polytetrafluoroethylene (PTFE). The materials demonstrate low friction, with minimized wear in dynamic and high speed applications. They are compatible to virtually all media, even at elevated temperatures, and are resistant to aging.
Operating temperatures: -196 °C to +260 °C / -320 °F to +500 °F
Recommended material: Turcon® M12

ZURCON® – Exceptional Wear Resistance

Zurcon® engineered thermoplastic-based materials exhibit outstanding friction characteristics, making them ideal for reciprocating, very slow rotating and oscillating situations where high wear resistance is required.
Operating temperatures: -60 °C to +260 °C / -76 °F to +500 °F
Recommended material: Zurcon® Z20

ORKOT® – Advanced Composite Polymers

Orkot® bearing materials are thermoset composites incorporating advanced polymer technologies. These consist of technical fabrics impregnated with thermosetting resins, evenly dispersed solid lubricants and further additives to ensure optimum performance.
Operating temperatures: -150 °C to +130 °C / -238 °F to +266 °F
Recommended material: Orkot® C380

HIMOD® – Economical Solution for Medium Loads

HiMod® provides an economical solution for applications with medium transverse loads, while giving good wear and compression properties.
Operating temperatures: -40 °C to +130 °C / -40 °F to +266 °F
Recommended materials: HM061 and HM062

TURCITE® – Stick-slip Free Operation

Turcite® material gives outstanding friction behavior, good load capacity, stick-slip free operation and good resistance to high temperatures and chemicals.
Operating temperatures: -60 °C to +200 °C / -75 °F to +390 °F
Recommended materials: Turcite® M12, T47, T51

ADDITIONAL APPLICATIONS – Seals for a full range of fluid power components

- Motors
- Gearboxes
- Transmissions
- Axles
- Rotary Actuators
- Fittings & Connectors
- Valves
- Accumulators
- Engines
- Filters
- Power Units

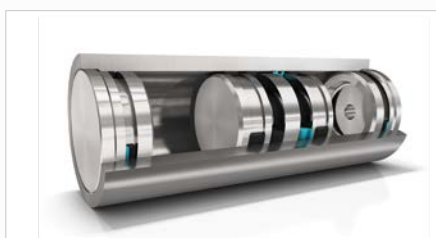

Trelleborg is a world leader in engineered polymer solutions that seal, damp and protect critical applications in demanding environments. Its innovative solutions accelerate performance for customers in a sustainable way.

Trelleborg Sealing Solutions is a leading developer, manufacturer and supplier of precision seals, bearings and custom-molded polymer components. It focuses on meeting the most demanding needs of aerospace, automotive and general industrial customers with innovative solutions.

WWW.TSS.TRELLEBORG.COM



facebook.com/TrelleborgSealingSolutions
twitter.com/TrelleborgSeals
youtube.com/TrelleborgSeals
linkedin.com/company/trelleborg-sealing-solutions

If you'd like to talk to Trelleborg Sealing Solutions, find your local contact at: www.tss.trelleborg.com/worldwide